

Data Sheet | Item Number: 859-730

Optocoupler module; Nominal input voltage: 24 VDC; Output voltage range: 3 ... 30 VDC; Limiting continuous current: 3 A; 2-wire connection; Module width: 6 mm; gray

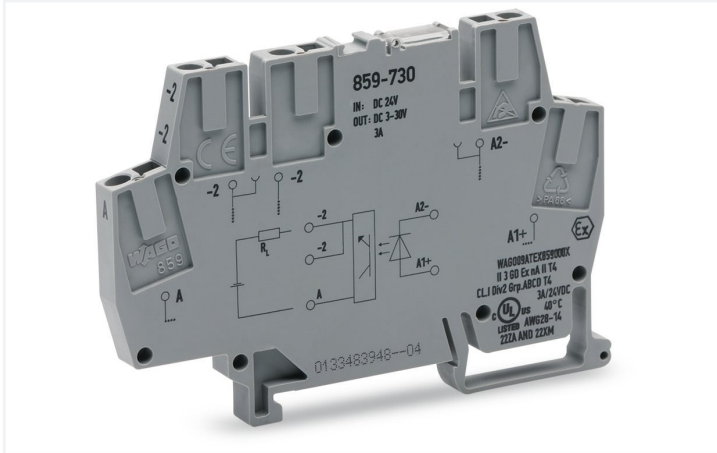

<https://www.wago.com/859-730>



Color: ■ gray

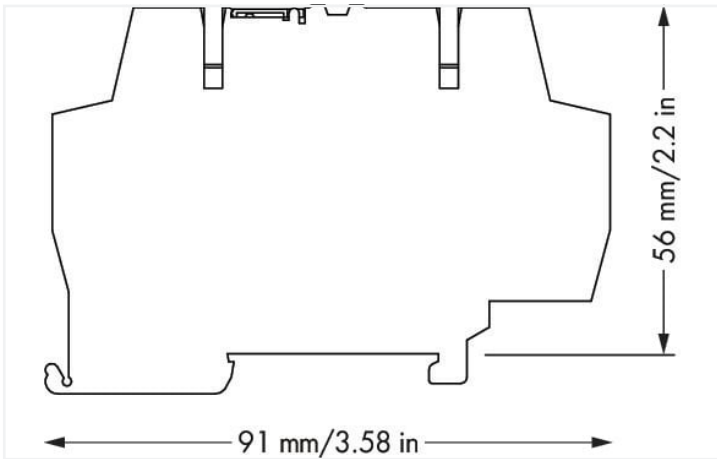
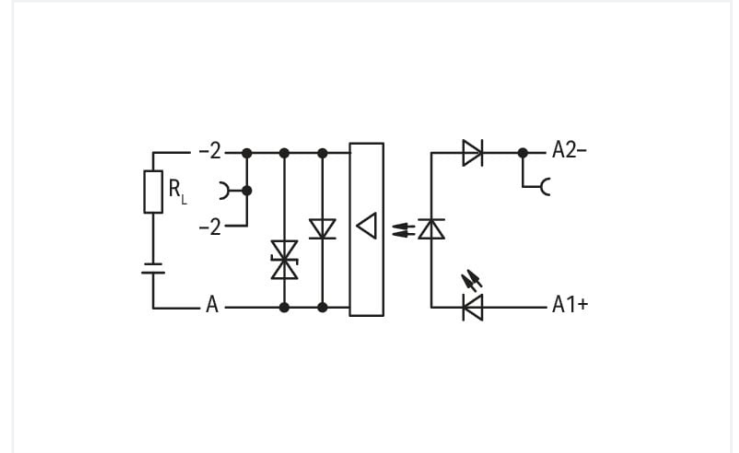

Dimensions in mm

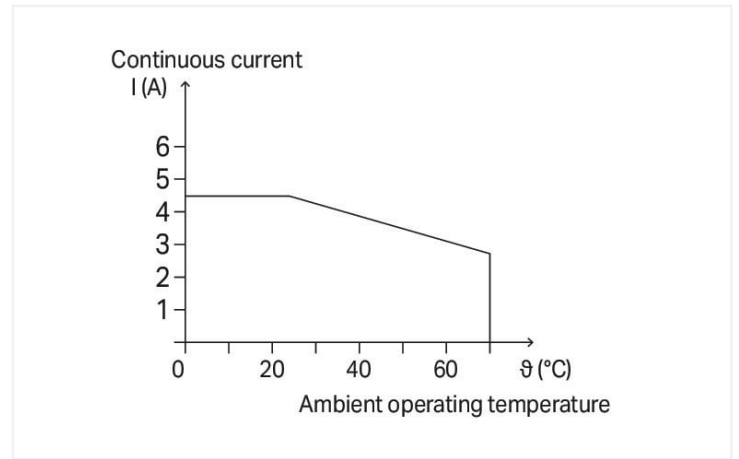

Current-carrying capacity curve

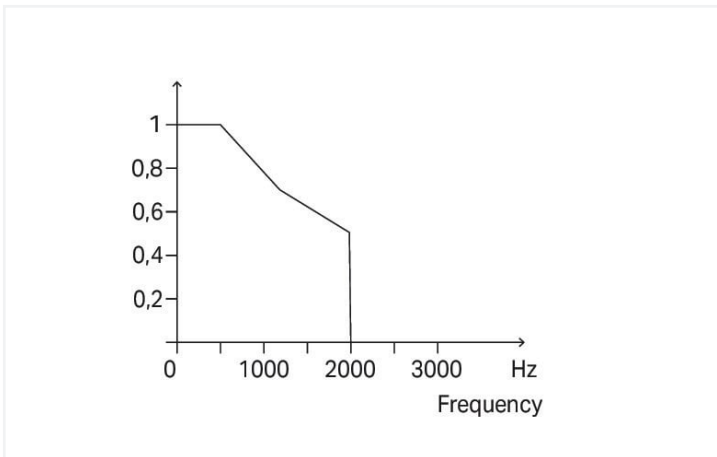

Load current correction factor

Notes

Note

Optocouplers and solid state relays are designed for use in signal processing networks, which are not supplied by the low-voltage power supply networks.

Technical data

Control circuit

Nominal input voltage U_N	DC 24 V
Input voltage range (low level)	DC 0 ... 7.5 V
Input voltage range (high level)	DC 12.5 ... 30 V
Nominal input current at U_N	15 mA

Load circuit

Circuit type	2-wire connection
Limiting continuous current	4.8 A
Peak output current	25 A
Nominal output voltage	DC 24 V
Output voltage range	DC 3 ... 30 V
Voltage drop	≤ 0.4 VDC
Leakage current at rated voltage	≤ 45 μ A
Turn-on time	≤ 20 μ s
Turn-off time	≤ 1 ms
Rise time (t_{10-90})	12 μ s
Drop-out time (t_{90-10})	15 μ s
Switching frequency	≤ 2.3 kHz

Signaling

Status indicator	Yellow LED
------------------	------------

Safety and protection

Rated voltage	300 V
Overvoltage category	II
Pollution degree	2
Dielectric strength (control/load circuit) (AC, 1 min)	2.5 kVrms
Insulation type (control/load circuit)	Basic insulation
Insulation type (between adjacent devices of the same type)	Reinforced insulation (safe isolation)
Insulation type (to adjacent devices of different types)	Basic insulation
Protection type	IP20; in connected state or when using 859-525 end plate

Connection data

Connection technology	CAGE CLAMP®
Solid conductor	0.2 ... 2.5 mm ² / 24 ... 14 AWG
Fine-stranded conductor	0.2 ... 2.5 mm ² / 24 ... 14 AWG
Fine-stranded conductor; with insulated ferrule	0.08 ... 1.5 mm ² / 28 ... 16 AWG
Fine-stranded conductor; with uninsulated ferrule	0.2 ... 1.5 mm ² / 24 ... 14 AWG
Strip length	5 ... 6 mm / 0.2 ... 0.24 inches

Physical data

Width	6 mm / 0.236 inches
Height	91 mm / 3.583 inches
Depth from upper-edge of DIN-rail	56 mm / 2.205 inches

Mechanical data

Mounting type	DIN-35 rail
Mounting position	horizontal (standing/lying); vertical

Material data

Color	gray
Fire load	0.338 MJ
Weight	18.5 g

Environmental requirements

Ambient temperature (operation at U_N)	-40 ... +70 °C
Ambient temperature UL (operation at U_N)	-40 ... +40 °C
Ambient temperature (storage)	-40 ... +70 °C
Processing temperature	-25 ... +50 °C
Temperature range of connection cable	$\geq (T_{\text{ambient}} + 20 \text{ K})$
Relative humidity	5 ... 95 % (no condensation permissible)
Operating altitude (max.)	2000 m

Standards and specifications

Standards/specifications	EN 61010-2-201 EN 61000-6-2 EN 61000-6-3 UL 508
--------------------------	--

Commercial data

Product Group	6 (INTERFACE ELECTRONIC)
eCl@ss 10.0	27-26-15-03
eCl@ss 9.0	27-26-15-03
ETIM 8.0	EC001504
ETIM 7.0	EC001504
PU (SPU)	10 pcs
Packaging type	Box
Country of origin	CN
GTIN	4055143604987
Customs tariff number	85365005000

Environmental Product Compliance

CAS-No.	7439-92-1 79-94-7
REACH Candidate List Substance	2,2',6,6'-tetrabromo-4,4'-isopropylidenediphenol Lead
RoHS Compliance Status	Compliant,With Exemption
RoHS Exemption	7(a) 7(c)-I 7(c)-II
SCIP notification number (Austria)	6556ad7b-5a4b-4263-9337-83906050ae4b
SCIP notification number (Belgium)	e660b4a5-a966-4c82-9feb-1b133db827e4
SCIP notification number (Bulgaria)	e4cf23dc-19f9-4ecc-9569-934b08d84818
SCIP notification number (Czech Republic)	83c7edbd-635b-4061-81af-325616a91c6a

Environmental Product Compliance

SCIP notification number (Denmark)	72941adf-b006-4c18-8519-1483302531e1
SCIP notification number (Finland)	7dc2413a-6773-4d8b-b5c9-8709a114d7e0
SCIP notification number (France)	76724e1c-686b-460e-bbf0-7d3cbb08ecd4
SCIP notification number (Germany)	9f4d9de4-780e-4359-8665-9cdd5198d414
SCIP notification number (Hungary)	61ec0ba0-0ed8-43fb-b3b6-6dc51b9f3b3b
SCIP notification number (Italy)	93c82f6e-f5f4-4662-a911-3807be285765
SCIP notification number (Netherlands)	06241b6c-7650-4848-b248-6c55f36e2645
SCIP notification number (Poland)	bcffc90f-ec1b-40ab-930c-8c6634d1e259
SCIP notification number (Romania)	e521904f-d719-43f4-80bc-4c2fee4e67d9
SCIP notification number (Sweden)	ae12280c-c32a-470f-9d04-fa5d360e9bf5

Approvals / Certificates

General approvals



Approval	Standard	Certificate Name
EAC Brjansker Zertifizierungsstelle	TP TC 020/2011	EAC_Certificate_RU_C-DE.AM02.B.00115_19
UL Underwriters Laboratories Inc. (ORDINARY LOCATIONS)	UL 508	E175199 Sec.4

Declarations of conformity and manufacturer's declarations

Approval	Standard	Certificate Name
EU-Declaration of Conformity WAGO GmbH & Co. KG	-	-

Approvals for hazardous areas



Approval	Standard	Certificate Name
CCC CNEX	CNCA-C23-01	2021312304000982 (Ex ec IIC T4 Gc)
UKEx WAGO GmbH & Co. KG	EN 60079-0	WAGO22UKEX007X_ec
UL Underwriters Laboratories Inc. (HAZARDOUS LOCATIONS)	ANSI/ISA 12.12.01	E198726

Downloads

Environmental Product Compliance

Compliance Search
Environmental Product Compliance 859-730

Documentation

Bid Text			
859-730	19.02.2019	xml 3.76 KB	↓
859-730	20.02.2019	docx 15.33 KB	↓

Instruction Leaflet			
CCC Ex (Additional information)	26.04.2023	pdf 132.68 KB	↓
Relay modules, Opto-coupler modules	V 2.0.0 19.01.2022	pdf 2066.27 KB	↓

CAD/CAE-Data	
CAD data	CAE data
2D/3D Models 859-730 ↓	EPLAN Data Portal 859-730 ↓
	WSCAD Universe 859-730 ↓
	ZUKEN Portal 859-730 ↓

1 Compatible Products

1.1 Optional Accessories

1.1.1 End plate

1.1.1.1 End plate



Item No.: 859-525
End and intermediate plate; 1 mm thick; gray

1.1.1.2 Intermediate plate



Item No.: 859-525
End and intermediate plate; 1 mm thick; gray

1.1.2 Ferrule

1.1.2.1 Ferrule



Item No.: 216-321
Ferrule; Sleeve for 0.25 mm² / AWG 24; insulated; electro-tin plated; yellow



Item No.: 216-322
Ferrule; Sleeve for 0.34 mm² / 22 AWG; insulated; electro-tin plated; light turquoise



Item No.: 216-221
Ferrule; Sleeve for 0.5 mm² / 20 AWG; insulated; electro-tin plated; white



Item No.: 216-222
Ferrule; Sleeve for 0.75 mm² / 18 AWG; insulated; electro-tin plated; gray



Item No.: 216-223
Ferrule; Sleeve for 1 mm² / AWG 18; insulated; electro-tin plated; red



Item No.: 216-224
Ferrule; Sleeve for 1.5 mm² / AWG 16; insulated; electro-tin plated; black

1.1.3 Jumper

1.1.3.1 Jumper



Item No.: 859-410/000-006
Jumper; for jumper slot; 10-way; insulated; blue

Item No.: 859-410
Jumper; for jumper slot; 10-way; insulated; light gray

Item No.: 859-410/000-005
Jumper; for jumper slot; 10-way; insulated; red

Item No.: 859-410/000-029
Jumper; for jumper slot; 10-way; insulated; yellow



Item No.: 859-402/000-006
Jumper; for jumper slot; 2-way; insulated; blue

Item No.: 859-402
Jumper; for jumper slot; 2-way; insulated; light gray

Item No.: 859-402/000-005
Jumper; for jumper slot; 2-way; insulated; red

Item No.: 859-402/000-029
Jumper; for jumper slot; 2-way; insulated; yellow



Item No.: 859-403/000-006
Jumper; for jumper slot; 3-way; insulated; blue

Item No.: 859-403
Jumper; for jumper slot; 3-way; insulated; light gray

Item No.: 859-403/000-005
Jumper; for jumper slot; 3-way; insulated; red

Item No.: 859-403/000-029
Jumper; for jumper slot; 3-way; insulated; yellow



Item No.: 859-404/000-006
Jumper; for jumper slot; 4-way; insulated; blue

Item No.: 859-404
Jumper; for jumper slot; 4-way; insulated; light gray

Item No.: 859-404/000-005
Jumper; for jumper slot; 4-way; insulated; red

Item No.: 859-404/000-029
Jumper; for jumper slot; 4-way; insulated; yellow



Item No.: 859-405/000-006
Jumper; for jumper slot; 5-way; insulated; blue

Item No.: 859-405
Jumper; for jumper slot; 5-way; insulated; light gray

Item No.: 859-405/000-005
Jumper; for jumper slot; 5-way; insulated; red

Item No.: 859-405/000-029
Jumper; for jumper slot; 5-way; insulated; yellow



Item No.: 859-406/000-006
Jumper; for jumper slot; 6-way; insulated; blue

Item No.: 859-406
Jumper; for jumper slot; 6-way; insulated; light gray

Item No.: 859-406/000-005
Jumper; for jumper slot; 6-way; insulated; red

Item No.: 859-406/000-029
Jumper; for jumper slot; 6-way; insulated; signal yellow



Item No.: 859-407/000-006
Jumper; for jumper slot; 7-way; insulated; blue

Item No.: 859-407
Jumper; for jumper slot; 7-way; insulated; light gray

Item No.: 859-407/000-005
Jumper; for jumper slot; 7-way; insulated; red

Item No.: 859-407/000-029
Jumper; for jumper slot; 7-way; insulated; yellow



Item No.: 859-408/000-006
Jumper; for jumper slot; 8-way; insulated; blue

Item No.: 859-408
Jumper; for jumper slot; 8-way; insulated; light gray

Item No.: 859-408/000-005
Jumper; for jumper slot; 8-way; insulated; red

Item No.: 859-408/000-029
Jumper; for jumper slot; 8-way; insulated; yellow



Item No.: 859-409/000-006
Jumper; for jumper slot; 9-way; insulated; blue

Item No.: 859-409
Jumper; for jumper slot; 9-way; insulated; light gray

Item No.: 859-409/000-005
Jumper; for jumper slot; 9-way; insulated; red

Item No.: 859-409/000-029
Jumper; for jumper slot; 9-way; insulated; yellow

1.1.4 Marking

1.1.4.1 Marker



Item No.: 2009-145
Mini-WSB Inline; for Smart Printer; 1700 pieces on roll; stretchable 5 - 5.2 mm; plain; snap-on type; white

Item No.: 248-502
Mini-WSB marking card; as card; MARKED; 1 ... 10 (10x); not stretchable; Horizontal marking; snap-on type; white

Item No.: 248-503
Mini-WSB marking card; as card; MARKED; 11 ... 20 (10x); not stretchable; Horizontal marking; snap-on type; white

Item No.: 248-504
Mini-WSB marking card; as card; MARKED; 21 ... 30 (10x); not stretchable; Horizontal marking; snap-on type; white



Item No.: 248-506
Mini-WSB marking card; as card; MARKED; 41 ... 50 (10x); not stretchable; Horizontal marking; snap-on type; white

Item No.: 248-501
Mini-WSB marking card; as card; not stretchable; plain; snap-on type; white

1.1.4.2 Marking devices



Item No.: 210-110

Fiber-tip pen

1.1.5 Test and measurement

1.1.5.1 Testing accessories



Item No.: 859-500

WAGO Test pin; 1 mm Ø; 30 V AC / 60 V DC; CAT0; 1 A; 10 mm uninsulated; Test lead for soldering up to 0,5mm²

1.1.6 Tool

1.1.6.1 Operating tool



Item No.: 210-720

Operating tool; Blade: 3.5 x 0.5 mm; with a partially insulated shaft; multicoloured

Installation Notes

Conductor termination

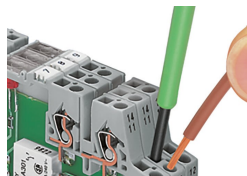

Conductor termination

Commoning

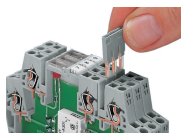

Easy commoning using adjacent jumpers

Marking



Marking via Mini-WSB Quick Marking System