

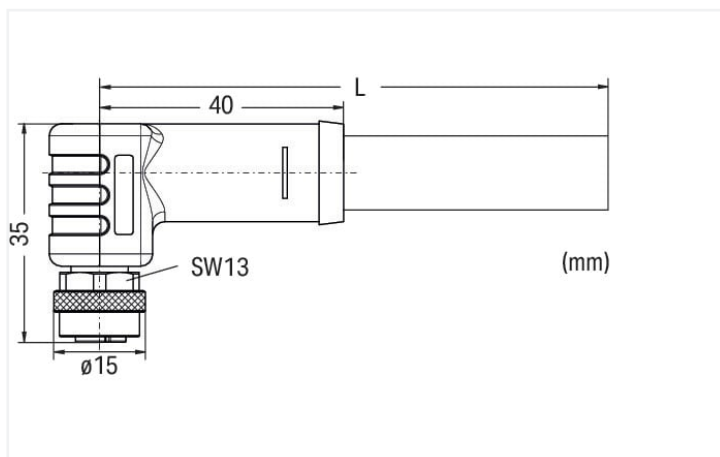

Pin 1 ... 4/FE: 1.5 mm²

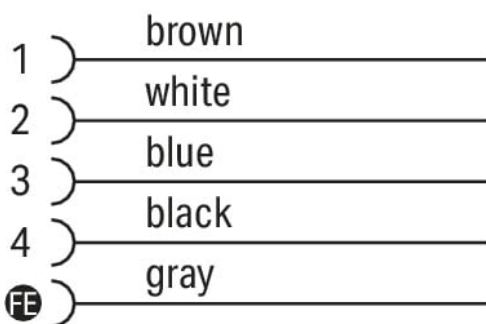

Short description:

These power cables are an accessory for the WAGO I/O System Field.

Use them as flexible, flame-retardant and halogen-free supply cables for industrial mechanical engineering applications – particularly those with high requirements, e.g., for use in cable chains (drag chains) and moving machine parts.

- Strong resistance to microbes and hydrolysis
- Good to very good weather resistance (UV and ozone)
- High resistance against welding sparks
- Excellent chemical and oil resistance
- Silicon- and PVC-free
- Free from paint-wetting impairment substances
- Flexible at low temperatures

Technical data

General information

Operating voltage	63 VDC per IEC 60664-1
Operating current	16 A
Rated surge voltage	1.5 kV per IEC 61076-2-111
Insulation resistance	1000 MΩ
Contact resistance	5 mΩ
Conductor resistance	≤ 13.7 Ω/km
Pollution degree	3 per IEC 60664-1
Protection type	IP68
Ambient temperature (operation)	-40 ... +90 °C (UL max. +80 °C)
Ambient (operating) temperature (static)	-40 ... +90 °C

General information

Ambient (operating) temperature (dynamic)	-30 ... +90 °C
---	----------------

Drag chain compatible

Bending radius	Fixed: >4xØ; Flexible: >7.5xØ
Bending cycles	10 million

Cable

Cable length	2 m
Type code	LiF9YH-11Y-0B 5x1.5mm ²
Conductor configuration	Bare copper wire (84 x 0.15 mm)
Conductor insulation	PP9Y (halogen-free)
Sheathed cable color	gray
Sheathed cable diameter	9.6 ... 10.2 mm

Connector

Connection type	M12 Socket - free end
Cable connection direction to mating direction	90 °
Connector interface coding (cable/adaptor) 1 1	L-coded
Housing material	TPU/TPU, black (~ RAL 9005)
Tightening torque	1 Nm

Commercial data

ETIM 8.0	EC001855
ETIM 7.0	EC003249
PU (SPU)	1 pcs
Packaging type	unpacked
Country of origin	DE
GTIN	4055143981972
Customs tariff number	85444290900

Environmental Product Compliance

RoHS Compliance Status	Compliant, No Exemption
------------------------	-------------------------

Approvals / Certificates

General approvals



Approval	Standard	Certificate Name
UL Underwriters Laboratories Inc.	UL 2237	E519600

Downloads

Environmental Product Compliance

Compliance Search

Environmental Product
Compliance
756-3502/050-020

