

Data Sheet | Item Number: 750-474

2-channel analog input; 4 ... 20 mA; Single-ended; 16 bits

<https://www.wago.com/750-474>



Color: ■ light gray

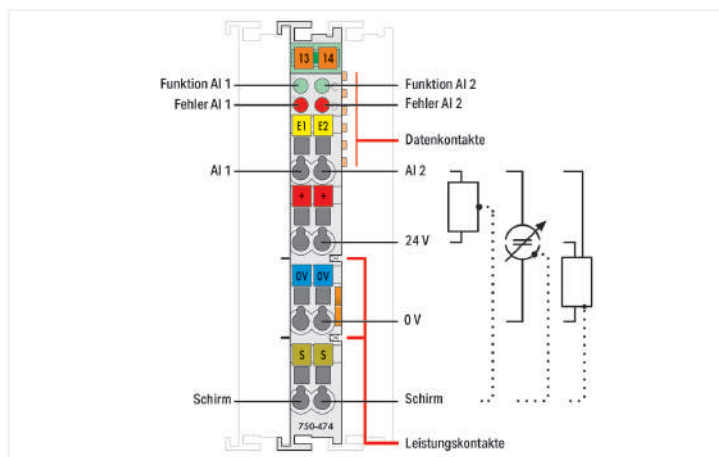
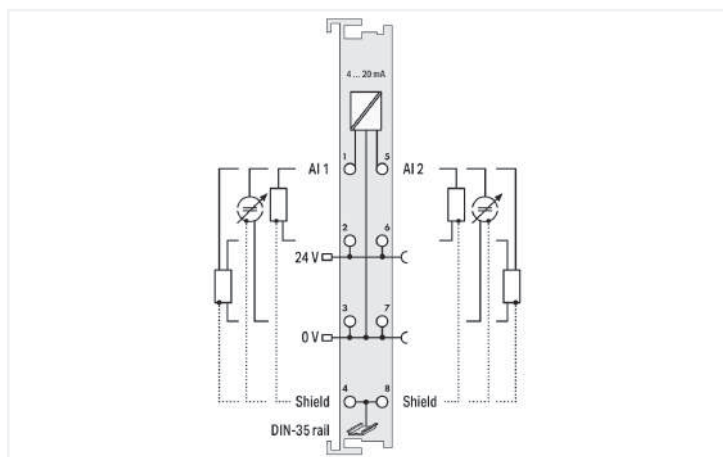
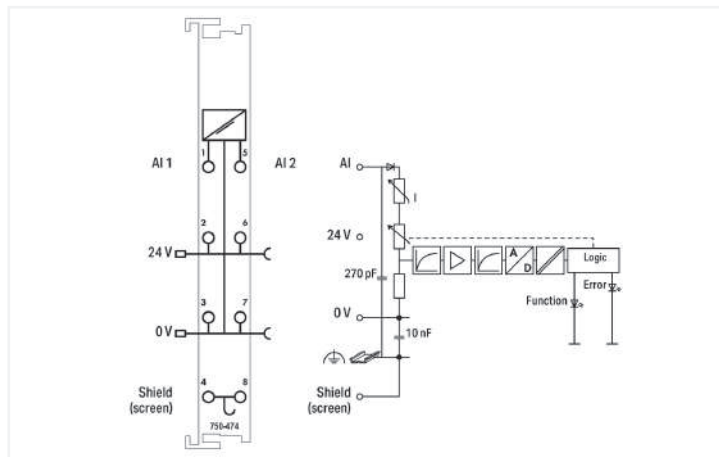

This analog input module powers field-side signal conditioners and transmits electrically isolated analog signals to the bus system.

The 24 V field supply is derived from the module's power jumper contacts.

The shield directly connects to the DIN-rail.

At approximately 25 mA, overload protection switches the measurement input to a high-resistance state. Once normal operating conditions resume, the measurement input will automatically switch back.

This module powers 2-wire signal conditioners without dedicated power supply.

Technical data

Number of analog inputs	2
Total number of channels (module)	2
Signal type	Current
Signal type (current)	4 ... 20 mADC
Sensor connection	2 x (2-wire, 3-wire)
Input filter frequency (analog)	50 Hz
Input voltage (max.)	24 V
Input voltage (note)	Non-linear, overload protected $U = 1.2 V + 160 \Omega \times I$ meas
Signal characteristics	Single-ended
Resolution [bit]	15 bits
Input resistance (max.)	220 Ω
Data width	2 x 16-bit data; 2 x 8-bit control/status (optional)
Overvoltage protection	30 V, reverse polarity protected
Noise rejection at sampling frequency	-100 dB
Noise rejection above sampling frequency	-40 dB
Conversion time (typ.)	80 ms
Measurement error (reference temperature)	25 °C

Technical data

Measurement error, deviation (max.) from the upper-range value	0.1 %
Temperature error (max.) of the upper-range value	0.01 %/K
Supply voltage (system)	5 VDC; via data contacts
Current consumption (5 V system supply)	75 mA
Supply voltage (field)	24 VDC (-25 ... +30 %); via power jumper contacts (power supply via blade contact; transmission via spring contact)
Isolation	500 V system/field
Indicators	LED (A, C) green: Function AI 1, AI 2; LED (B, D) red: Error AI 1, AI 2
Number of incoming power jumper contacts	2
Number of outgoing power jumper contacts	2

Connection data

Connection technology: inputs/outputs	8 x CAGE CLAMP®
Connection type 1	Inputs/outputs
Solid conductor	0.08 ... 2.5 mm ² / 28 ... 14 AWG
Fine-stranded conductor	0.08 ... 2.5 mm ² / 28 ... 14 AWG
Strip length	8 ... 9 mm / 0.31 ... 0.35 inches

Physical data

Width	12 mm / 0.472 inches
Height	100 mm / 3.937 inches
Depth	69.8 mm / 2.748 inches
Depth from upper-edge of DIN-rail	62.6 mm / 2.465 inches

Mechanical data

Mounting type	DIN-35 rail
---------------	-------------

Material data

Color	light gray
Housing material	Polycarbonate; polyamide 6.6
Fire load	1.048 MJ
Weight	53.2 g
Conformity marking	CE

Environmental requirements

Ambient temperature (operation)	0 ... +55 °C
Ambient temperature (storage)	-25 ... +85 °C
Protection type	IP20
Pollution degree	2 per IEC 61131-2
Operating altitude	0 ... 2000 m / 0 ... 6562 ft
Mounting position	horizontal (standing/lying); vertical
Relative humidity (without condensation)	95 %
Vibration resistance	4g per IEC 60068-2-6
Shock resistance	15g per IEC 60068-2-27
EMC immunity to interference	per EN 61000-6-2, marine applications
EMC emission of interference	per EN 61000-6-4, marine applications
Exposure to pollutants	per IEC 60068-2-42 and IEC 60068-2-43
Permissible H ₂ S contaminant concentration at a relative humidity 75 %	10 ppm
Permissible SO ₂ contaminant concentration at a relative humidity 75 %	25 ppm

Commercial data

Product Group	15 (I/O System)
eCl@ss 10.0	27-24-26-01
eCl@ss 9.0	27-24-26-01
ETIM 8.0	EC001596
ETIM 7.0	EC001596
PU (SPU)	1 pcs
Packaging type	Box
Country of origin	DE
GTIN	4045454393281
Customs tariff number	85389099990

Environmental Product Compliance

CAS-No.	1303-86-2 1317-36-8 7439-92-1
REACH Candidate List Substance	Diboron trioxide Lead Lead monoxide
RoHS Compliance Status	Compliant,With Exemption
RoHS Exemption	6(c) 7(a) 7(c)-I 7(c)-II
SCIP notification number (Austria)	8b7cabf0-2cd3-4b94-a73b-220efe7637ab
SCIP notification number (Belgium)	64998619-9c63-4aef-8424-08a9731dd0b9
SCIP notification number (Bulgaria)	015eb609-f94e-4871-bedd-708d326594a8
SCIP notification number (Czech Republic)	37ad1a74-e5b9-4261-971a-963ff93b5c68
SCIP notification number (Denmark)	2b74c0cf-718b-4962-a1c8-167ef90f7f60
SCIP notification number (Finland)	e9b13a53-b1da-4f07-9382-fc34bfa722ad
SCIP notification number (France)	cbc9da82-872a-412b-857d-32c3ff56a3e2
SCIP notification number (Germany)	61b222de-d4a1-495b-91bc-04e250e262c2
SCIP notification number (Hungary)	3d46027c-a572-479c-b06b-4809717da8f7
SCIP notification number (Italy)	129d03e0-9ea8-4e9b-9869-e4501c2b41c4
SCIP notification number (Netherlands)	d3d94746-27cb-4371-a0a4-21015aa9e49a
SCIP notification number (Poland)	f5e09e60-116f-48e4-b2b9-9e9ff51e640c
SCIP notification number (Romania)	db34ae3d-a842-431f-a7da-4d5aac50f6b1
SCIP notification number (Sweden)	91f87b05-282c-44a2-910c-3cb43ea7cf18

Approvals / Certificates

General approvals



Approval	Standard	Certificate Name
EAC Brjansker Zertifizierungs- stelle	TP TC 020/2011	EAC RU C-DE.AM02. B.00087/19
KC National Radio Research Agency	Article 58-2, Clause 3	MSIP-REM-W43-AIM750
UL Underwriters Laboratories Inc. (ORDINARY LOCATI- ONS)	UL 508	E175199 Sec.1

Declarations of conformity and manufacturer's declarations

Approval	Standard	Certificate Name
EU-Declaration of Confor- mity WAGO GmbH & Co. KG	-	-
UK-Declaration of Confor- mity WAGO GmbH & Co. KG	-	-

Approvals for marine applications



Approval	Standard	Certificate Name
ABS American Bureau of Shipping	-	22-2219060
BSH Bundesamt fuer Seeschifffahrt und Hydrographie	-	1104
BV Bureau Veritas S.A.	-	13453/E0 BV
DNV DNV GL SE	DNV-CG-0339, Aug. 2021	TAA0000194
KR Korean Register of Shipping	-	KR HMB05880-AC001
LR Lloyds Register EMEA	-	LR22180952TA
PRS Polski Rejestr Statków	-	TE/2236/880590/19
RINA RINA Germany GmbH	-	ELE343521XG001

Approvals for hazardous areas



Approval	Standard	Certificate Name
ATEX TUEV Nord Cert GmbH	EN 60079-0	
CCC CNEC	CNCA-C23-01	2020312310000213 (Ex ec IIC T4 Gc)
EAC Brjansker Zertifizierungsstelle	TP TC 012/2011	EAC RU C-DE.AM02. B.00163/19 (2Ex nA IIC T4 Gc X)
IECEX TUEV Nord Cert GmbH	IEC 60079-0	IECEX TUN 14.0035 X (Ex ec IIC T4 Gc)
INMETRO TUV Rheinland do Brasil Ltda.	IEC 60079-0	BR-Ex_TUV 12.1297 X
UKEx WAGO GmbH & Co. KG	EN 60079-0	UKCA_WA GO22UKEX003X_ec
UL Underwriters Laboratories Inc. (HAZARDOUS LOCATIONS)	UL 121201	E198726 Sec.1

Downloads

Environmental Product Compliance

Compliance Search
Environmental Product Compliance 750-474 ↓

Documentation

Manual			
Product Manual 2-channel, 4-20mA, single-ended	V 1.1.0	pdf 2103.52 KB	↓
System Manual WAGO I/O System 750/753	V 3.3.0 04.05.2023	pdf 8548.45 KB	↓
System Manual Series 750/753			↓

System Description			
750/753 Series I/O-System – General Product Information		pdf 953.35 KB	↓
Overview on WAGO-I/O-SYSTEM 750 approvals		pdf 770.48 KB	↓

Bid Text			
750-474	19.02.2019	xml 4.71 KB	↓
750-474	17.10.2017	doc 28.00 KB	↓

Instruction Leaflet			
CCC Ex (Additional information)	26.04.2023	pdf 159.76 KB	↓

CAD/CAE-Data

CAD data	
2D/3D Models 750-474	

CAE data	
EPLAN Data Portal 750-474	
WSCAD Universe 750-474	
ZUKEN Portal 750-474	

Device Files

Device Driver			
WAGO USB Service Kabel Treiber / Serie 750 und 857	6.5.3.0 10.09.2014	zip 4721.96 KB	

1 Compatible Products

1.1 Optional Accessories

1.1.1 DIN-rail

1.1.1.1 Mounting accessories



Item No.: 210-196
Aluminum carrier rail; 35 x 8.2 mm; 1.6 mm thick; 2 m long; unslotted; similar to EN 60715; silver-colored



Item No.: 210-198
Copper carrier rail; 35 x 15 mm; 2.3 mm thick; 2 m long; unslotted; according to EN 60715; copper-colored



Item No.: 210-508
Steel carrier rail; 35 x 15 mm; 1.5 mm thick; 2 m long; slotted; galvanized; similar to EN 60715; silver-colored



Item No.: 210-197
Steel carrier rail; 35 x 15 mm; 1.5 mm thick; 2 m long; slotted; similar to EN 60715; silver-colored



Item No.: 210-506
Steel carrier rail; 35 x 15 mm; 1.5 mm thick; 2 m long; unslotted; galvanized; similar to EN 60715; silver-colored



Item No.: 210-114
Steel carrier rail; 35 x 15 mm; 1.5 mm thick; 2 m long; unslotted; similar to EN 60715; silver-colored



Item No.: 210-118
Steel carrier rail; 35 x 15 mm; 2.3 mm thick; 2 m long; unslotted; according to EN 60715; silver-colored



Item No.: 210-115
Steel carrier rail; 35 x 7.5 mm; 1 mm thick; 2 m long; slotted; according to EN 60715; "Hole width 18 mm; silver-colored



Item No.: 210-112
Steel carrier rail; 35 x 7.5 mm; 1 mm thick; 2 m long; slotted; according to EN 60715; "Hole width 25 mm; silver-colored



Item No.: 210-504
Steel carrier rail; 35 x 7.5 mm; 1 mm thick; 2 m long; slotted; galvanized; according to EN 60715; silver-colored



Item No.: 210-113
Steel carrier rail; 35 x 7.5 mm; 1 mm thick; 2 m long; unslotted; according to EN 60715; silver-colored



Item No.: 210-505
Steel carrier rail; 35 x 7.5 mm; 1 mm thick; 2 m long; unslotted; galvanized; according to EN 60715; silver-colored



















1.1.2 Marking

1.1.2.1 Group marker carrier



Item No.: 750-106
Group marker carrier

1.1.2.2 Marker

 Item No.: 750-100 Marker card; as a DIN A4 sheet; plain	 Item No.: 2009-145/000-006 Mini-WSB Inline; for Smart Printer; 1700 pieces on roll; stretchable 5 - 5.2 mm; plain; snap-on type; blue	 Item No.: 2009-145/000-007 Mini-WSB Inline; for Smart Printer; 1700 pieces on roll; stretchable 5 - 5.2 mm; plain; snap-on type; gray	 Item No.: 2009-145/000-023 Mini-WSB Inline; for Smart Printer; 1700 pieces on roll; stretchable 5 - 5.2 mm; plain; snap-on type; green
 Item No.: 2009-145/000-012 Mini-WSB Inline; for Smart Printer; 1700 pieces on roll; stretchable 5 - 5.2 mm; plain; snap-on type; orange	 Item No.: 2009-145/000-005 Mini-WSB Inline; for Smart Printer; 1700 pieces on roll; stretchable 5 - 5.2 mm; plain; snap-on type; red	 Item No.: 2009-145/000-024 Mini-WSB Inline; for Smart Printer; 1700 pieces on roll; stretchable 5 - 5.2 mm; plain; snap-on type; violet	 Item No.: 2009-145 Mini-WSB Inline; for Smart Printer; 1700 pieces on roll; stretchable 5 - 5.2 mm; plain; snap-on type; white
 Item No.: 2009-145/000-002 Mini-WSB marking card; as card; not stretchable; plain; snap-on type; yellow	 Item No.: 248-501/000-006 Mini-WSB marking card; as card; not stretchable; plain; snap-on type; blue	 Item No.: 248-501/000-007 Mini-WSB marking card; as card; not stretchable; plain; snap-on type; gray	 Item No.: 248-501/000-023 Mini-WSB marking card; as card; not stretchable; plain; snap-on type; green
 Item No.: 248-501/000-017 Mini-WSB marking card; as card; not stretchable; plain; snap-on type; light green	 Item No.: 248-501/000-012 Mini-WSB marking card; as card; not stretchable; plain; snap-on type; orange	 Item No.: 248-501/000-005 Mini-WSB marking card; as card; not stretchable; plain; snap-on type; red	 Item No.: 248-501/000-024 Mini-WSB marking card; as card; not stretchable; plain; snap-on type; violet
 Item No.: 248-501 Mini-WSB marking card; as card; not stretchable; plain; snap-on type; white	 Item No.: 248-501/000-002 Mini-WSB marking card; as card; not stretchable; plain; snap-on type; yellow		

1.1.2.3 Marker carrier

 Item No.: 750-103 Group marker carrier

1.1.3 Shield termination

1.1.3.1 Shield clamping saddles

 Item No.: 790-108 Shield clamping saddle; 11 mm wide; diameter of compatible conductor; 3 ... 8 mm	 Item No.: 790-208 Shield clamping saddle; 12.4 mm wide; 3 ... 8 mm	 Item No.: 790-116 Shield clamping saddle; 19 mm wide; diameter of compatible conductor; 7 ... 16 mm	 Item No.: 790-216 Shield clamping saddle; 21.8 mm wide; 6 ... 16 mm
 Item No.: 790-124 Shield clamping saddle; 27 mm wide; diameter of compatible conductor; 6 ... 24 mm	 Item No.: 790-220 Shield clamping saddle; 30 mm wide; 6 ... 20 mm	 Item No.: 790-140 Shield clamping saddle; diameter of compatible conductor	

1.1.4 Supply module

1.1.4.1 Supply module



Item No.: 750-612
Power Supply; 0 ... 230 V AC/DC

Item No.: 750-602
Power Supply; 24 VDC

Item No.: 750-601
Power Supply; 24 VDC; fuse holder

Item No.: 750-610
Power Supply; 24 VDC; fuse holder; Diagnostics

1.1.5 System enclosure

1.1.5.1 System enclosure



Item No.: 850-825
IP65 enclosure; Aluminium (RAL 7032); WxHxD (160x100x160 mm); 9 x M12, 4 x M20

Item No.: 850-826
IP65 enclosure; Aluminium (RAL 7032); WxHxD (240x100x160 mm); 4 x M20, 4 x M16, 14 x M12 cable grip

Item No.: 850-827
IP65 enclosure; Aluminium (RAL 7032); WxHxD (320x100x160 mm); 4 x M20, 8 x M16, 17 x M12 cable grip

Item No.: 850-828
IP65 enclosure; Aluminium (RAL 7032); WxHxD (480x100x160 mm); 4 x M20, 10 x M16, 35 x M12 cable grip



Item No.: 850-826/002-000
IP65 enclosure; Aluminium (RAL 7035); WxHxD (240x100x160 mm); 4 x M20, 4 x M16, 14 x M12 cable grip

Item No.: 850-827/002-000
IP65 enclosure; Aluminium (RAL 7035); WxHxD (320x100x160 mm); 4 x M20, 8 x M16, 17 x M12 cable grip

Item No.: 850-828/002-000
IP65 enclosure; Aluminium (RAL 7035); WxHxD (480x100x160 mm); 4 x M20, 10 x M16, 35 x M12 cable grip

Item No.: 850-834
IP65 enclosure; Polyester (RAL 7032); WxHxD (164x100x164 mm); 9 x M12, 4 x M20



Item No.: 850-835
IP65 enclosure; Polyester (RAL 7032); WxHxD (244x100x164 mm); 4 x M20, 4 x M16, 14 x M12 cable grip

Item No.: 850-836
IP65 enclosure; Polyester (RAL 7032); WxHxD (324x100x164 mm); 4 x M20, 8 x M16, 17 x M12 cable grip

Item No.: 850-814/002-000
IP65 enclosure; Sheet steel (RAL 7035); WxHxD (200x120x200 mm); without flange plate

Item No.: 850-815/002-000
IP65 enclosure; Sheet steel (RAL 7035); WxHxD (300x120x200 mm); without flange plate



Item No.: 850-816/002-000
IP65 enclosure; Sheet steel (RAL 7035); WxHxD (400x120x200 mm); without flange plate

Item No.: 850-817/002-000
IP65 enclosure; Sheet steel (RAL 7035); WxHxD (600x120x200 mm); without flange plate