



SIRIUS soft starter S2 72 A, 37 kW/400 V, 40 °C 200-480 V AC, 110-230 V AC/DC spring-type terminals

General technical data		
product brand name		SIRIUS
product feature		
• integrated bypass contact system		Yes
• thyristors		Yes
product function		
• intrinsic device protection		No
• motor overload protection		No
• evaluation of thermistor motor protection		No
• external reset		No
• adjustable current limitation		No
• inside-delta circuit		No
product component motor brake output		No
insulation voltage rated value	V	600
degree of pollution		3, acc. to IEC 60947-4-2
reference code according to EN 61346-2		Q
reference code according to DIN 40719 extended according to IEC 204-2 according to IEC 750		G
Power Electronics		
product designation		Soft starter
operational current		
• at 40 °C rated value	A	72
• at 50 °C rated value	A	62
• at 60 °C rated value	A	60
yielded mechanical performance for 3-phase motors		
• at 230 V		
— at standard circuit at 40 °C rated value	kW	22
• at 400 V		
— at standard circuit at 40 °C rated value	kW	37
yielded mechanical performance [hp] for 3-phase AC motor at 200/208 V at standard circuit at 50 °C rated value	hp	20
operating frequency rated value	Hz	50 ... 60
relative negative tolerance of the operating frequency	%	-10
relative positive tolerance of the operating frequency	%	10
operating voltage at standard circuit rated value	V	200 ... 480
relative negative tolerance of the operating voltage at standard circuit	%	-15
relative positive tolerance of the operating voltage at standard circuit	%	10
minimum load [%]	%	10
continuous operating current [% of I _e] at 40 °C	%	115

power loss [W] at operational current at 40 °C during operation typical	W	15
Control circuit/ Control		
type of voltage of the control supply voltage		AC/DC
control supply voltage frequency 1 rated value	Hz	50
control supply voltage frequency 2 rated value	Hz	60
relative negative tolerance of the control supply voltage frequency	%	-10
relative positive tolerance of the control supply voltage frequency	%	10
control supply voltage 1 at AC at 50 Hz	V	110 ... 230
control supply voltage 1 at AC at 60 Hz	V	110 ... 230
relative negative tolerance of the control supply voltage at AC at 50 Hz	%	-10
relative positive tolerance of the control supply voltage at AC at 50 Hz	%	10
relative negative tolerance of the control supply voltage at AC at 60 Hz	%	-10
relative positive tolerance of the control supply voltage at AC at 60 Hz	%	10
control supply voltage 1 at DC	V	110 ... 230
relative negative tolerance of the control supply voltage at DC	%	-10
relative positive tolerance of the control supply voltage at DC	%	10
display version for fault signal		red
Mechanical data		
size of engine control device		S2
width	mm	55
height	mm	160
depth	mm	170
fastening method		screw and snap-on mounting
mounting position		With vertical mounting surface +/-10° rotatable, with vertical mounting surface +/- 10° tiltable to the front and back
required spacing with side-by-side mounting		
• upwards	mm	60
• at the side	mm	30
• downwards	mm	40
wire length maximum	m	300
number of poles for main current circuit		3
Connections/ Terminals		
type of electrical connection		
• for main current circuit		screw-type terminals
• for auxiliary and control circuit		spring-loaded terminals
number of NC contacts for auxiliary contacts		0
number of NO contacts for auxiliary contacts		1
number of CO contacts for auxiliary contacts		0
type of connectable conductor cross-sections for main contacts for box terminal using the front clamping point		
• solid		2x (1.5 ... 16 mm ²)
• finely stranded with core end processing		1.5 ... 25 mm ²
• stranded		1.5 ... 35 mm ²
type of connectable conductor cross-sections for main contacts for box terminal using the back clamping point		
• solid		2x (1.5 ... 16 mm ²)
• finely stranded with core end processing		1.5 ... 25 mm ²
• stranded		1.5 ... 35 mm ²
type of connectable conductor cross-sections for main contacts for box terminal using both clamping points		
• solid		2x (1.5 ... 16 mm ²)
• finely stranded with core end processing		2x (1.5 ... 16 mm ²)
• stranded		2x (1.5 ... 25 mm ²)
type of connectable conductor cross-sections for AWG cables for main contacts for box terminal		
• using the back clamping point		16 ... 2

<ul style="list-style-type: none"> • using the front clamping point • using both clamping points 		18 ... 2 2x (16 ... 2)
type of connectable conductor cross-sections for auxiliary contacts <ul style="list-style-type: none"> • solid • finely stranded with core end processing 		2x (0.25 ... 2.5 mm ²) 2x (0.25 ... 1.5 mm ²)
type of connectable conductor cross-sections for AWG cables <ul style="list-style-type: none"> • for auxiliary contacts 		2x (24 ... 14)

Ambient conditions

installation altitude at height above sea level	m	5 000
environmental category <ul style="list-style-type: none"> • during transport according to IEC 60721 • during storage according to IEC 60721 • during operation according to IEC 60721 		2K2, 2C1, 2S1, 2M2 (max. fall height 0.3 m) 1K6 (only occasional condensation), 1C2 (no salt mist), 1S2 (sand must not get inside the devices), 1M4 3K6 (no formation of ice, no condensation), 3C3 (no salt mist), 3S2 (sand must not get into the devices), 3M6
ambient temperature <ul style="list-style-type: none"> • during operation • during storage 	°C	-25 ... +60 -40 ... +80
derating temperature	°C	40
protection class IP on the front according to IEC 60529		IP20
touch protection on the front according to IEC 60529		finger-safe, for vertical contact from the front

UL/CSA ratings

yielded mechanical performance [hp] for 3-phase AC motor <ul style="list-style-type: none"> • at 220/230 V <ul style="list-style-type: none"> — at standard circuit at 50 °C rated value • at 460/480 V <ul style="list-style-type: none"> — at standard circuit at 50 °C rated value 	hp	20 40
contact rating of auxiliary contacts according to UL		B300 / R300

Approvals Certificates

General Product Approval



[Confirmation](#)



General Product Approval	EMV	Test Certificates	other
--------------------------	-----	-------------------	-------



[KC](#)

[Type Test Certificates/Test Report](#)

[Special Test Certificate](#)

[Miscellaneous](#)

other	Railway	Environment
-------	---------	-------------

[Confirmation](#)

[Special Test Certificate](#)

[Confirmation](#)

[Environmental Confirmations](#)

Further information

Simulation Tool for Soft Starters (STS)

<https://support.industry.siemens.com/cs/ww/en/view/101494917>

Information on the packaging

<https://support.industry.siemens.com/cs/ww/en/view/109813875>

Information- and Downloadcenter (Catalogs, Brochures,...)

<https://www.siemens.com/ic10>

Industry Mall (Online ordering system)

<https://mall.industry.siemens.com/mall/en/en/Catalog/product?mlfb=3RW3038-2BB14>

Cax online generator

<http://support.automation.siemens.com/WW/CAXorder/default.aspx?lang=en&mlfb=3RW3038-2BB14>

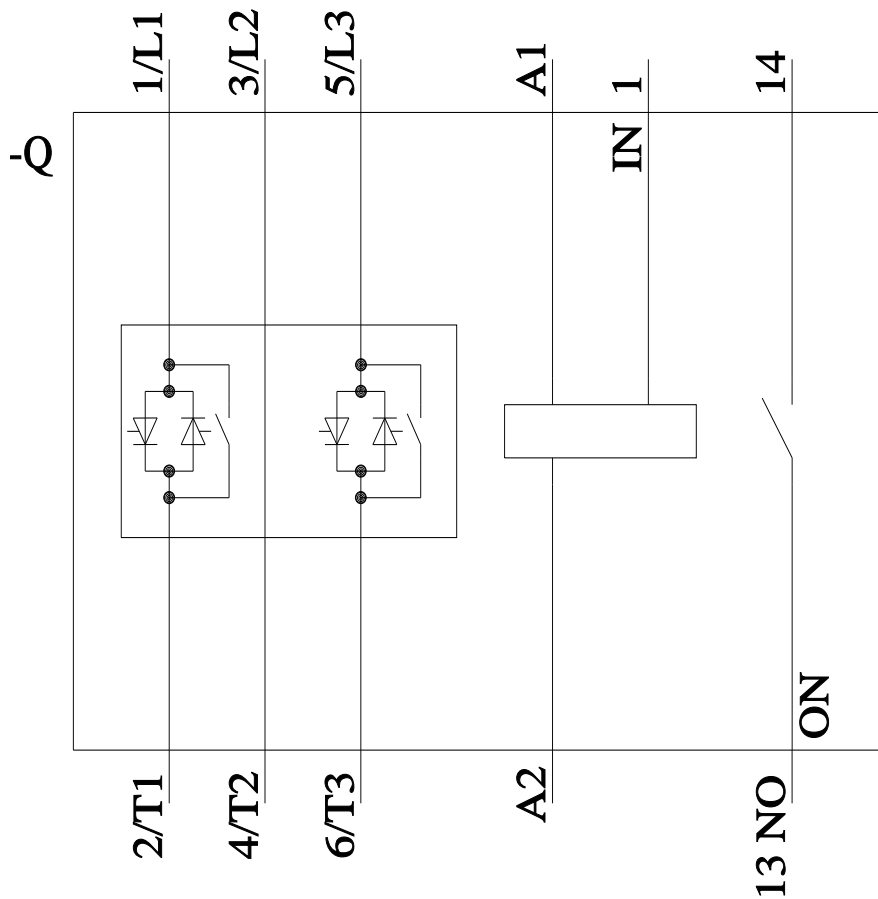
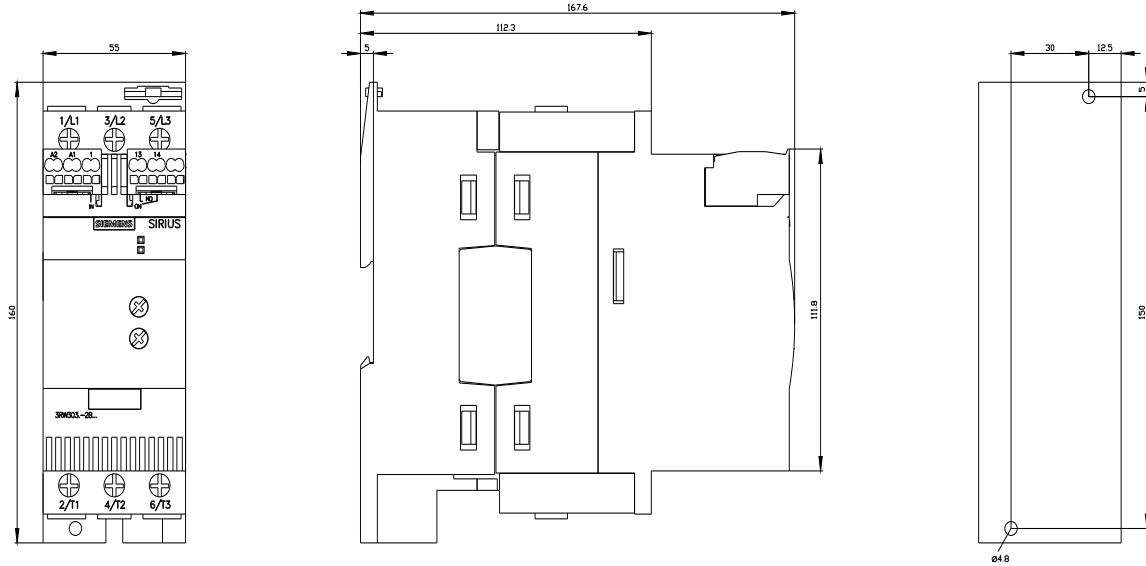

last modified:

3/11/2024 