

# SKiiP 35NAB12T4V1

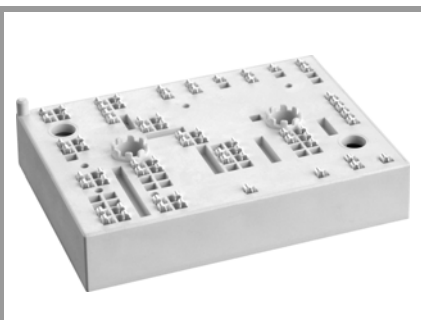

MiniSKiiP® 3

## Converter-Inverter-Brake (CIB)

### SKiiP 35NAB12T4V1

#### Features\*

- Trench 4 IGBTs
- Robust and soft switching freewheeling diodes in CAL technology
- Highly reliable spring contacts for electrical connections
- UL recognized: File no. E63532

#### Typical Applications

- Inverter up to 26 kVA
- Typical motor power 15 kW

#### Remarks

- Max. case temperature limited to  $T_C=125^\circ\text{C}$
- Product reliability results valid for  $T_j \leq 150^\circ\text{C}$  (recommended  $T_{j,op} = -40 \dots +150^\circ\text{C}$ )
- MiniSKiiP "Technical Explanations" and "Mounting Instructions" are part of the data sheet. Please refer to both documents for further information

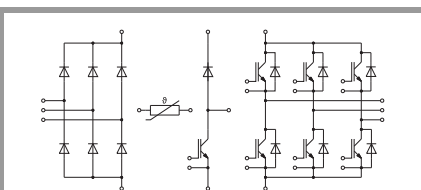

NAB

Absolute Maximum Ratings				
Symbol	Conditions		Values	Unit
<b>Inverter - IGBT</b>				
$V_{CES}$	$T_j = 25^\circ\text{C}$		1200	V
$I_C$	$\lambda_{paste}=0.8 \text{ W/(mK)}$	$T_s = 25^\circ\text{C}$	69	A
		$T_j = 175^\circ\text{C}$	55	A
$I_C$	$\lambda_{paste}=2.5 \text{ W/(mK)}$	$T_s = 25^\circ\text{C}$	77	A
		$T_s = 70^\circ\text{C}$	63	A
$I_{Chom}$			50	A
$I_{CRM}$			150	A
$V_{GES}$			-20 ... 20	V
$t_{psc}$	$V_{CC} = 800 \text{ V}$ $V_{GE} \leq 15 \text{ V}$ $V_{CES} \leq 1200 \text{ V}$	$T_j = 150^\circ\text{C}$	10	$\mu\text{s}$
$T_j$			-40 ... 175	$^\circ\text{C}$
<b>Chopper - IGBT</b>				
$V_{CES}$	$T_j = 25^\circ\text{C}$		1200	V
$I_C$	$\lambda_{paste}=0.8 \text{ W/(mK)}$	$T_s = 25^\circ\text{C}$	68	A
		$T_j = 175^\circ\text{C}$	55	A
$I_C$	$\lambda_{paste}=2.5 \text{ W/(mK)}$	$T_s = 25^\circ\text{C}$	77	A
		$T_s = 70^\circ\text{C}$	63	A
$I_{Chom}$			50	A
$I_{CRM}$			150	A
$V_{GES}$			-20 ... 20	V
$t_{psc}$	$V_{CC} = 800 \text{ V}$ $V_{GE} \leq 15 \text{ V}$ $V_{CES} \leq 1200 \text{ V}$	$T_j = 150^\circ\text{C}$	10	$\mu\text{s}$
$T_j$			-40 ... 175	$^\circ\text{C}$
<b>Inverse - Diode</b>				
$V_{RRM}$	$T_j = 25^\circ\text{C}$		1200	V
$I_F$	$\lambda_{paste}=0.8 \text{ W/(mK)}$	$T_s = 25^\circ\text{C}$	60	A
		$T_j = 175^\circ\text{C}$	48	A
$I_F$	$\lambda_{paste}=2.5 \text{ W/(mK)}$	$T_s = 25^\circ\text{C}$	68	A
		$T_s = 70^\circ\text{C}$	54	A
$I_{FRM}$			150	A
$I_{FSM}$	$t_p = 10 \text{ ms, sin } 180^\circ, T_j = 150^\circ\text{C}$		270	A
$T_j$			-40 ... 175	$^\circ\text{C}$
<b>Freewheeling - Diode</b>				
$V_{RRM}$	$T_j = 25^\circ\text{C}$		1200	V
$I_F$	$\lambda_{paste}=0.8 \text{ W/(mK)}$	$T_s = 25^\circ\text{C}$	60	A
		$T_j = 175^\circ\text{C}$	48	A
$I_F$	$\lambda_{paste}=2.5 \text{ W/(mK)}$	$T_s = 25^\circ\text{C}$	68	A
		$T_s = 70^\circ\text{C}$	54	A
$I_{FRM}$			150	A
$I_{FSM}$	$t_p = 10 \text{ ms, sin } 180^\circ, T_j = 150^\circ\text{C}$		270	A
$T_j$			-40 ... 175	$^\circ\text{C}$

# SKiiP 35NAB12T4V1

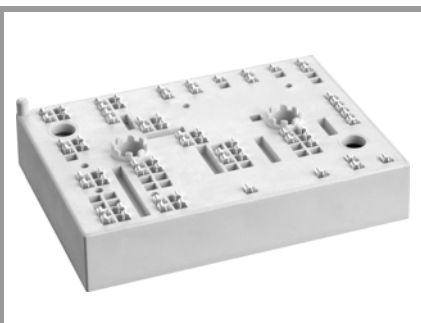

MiniSKiiP® 3

## Converter-Inverter-Brake (CIB)

### SKiiP 35NAB12T4V1

#### Features\*

- Trench 4 IGBTs
- Robust and soft switching freewheeling diodes in CAL technology
- Highly reliable spring contacts for electrical connections
- UL recognized: File no. E63532

#### Typical Applications

- Inverter up to 26 kVA
- Typical motor power 15 kW

#### Remarks

- Max. case temperature limited to  $T_C=125^\circ\text{C}$
- Product reliability results valid for  $T_j \leq 150^\circ\text{C}$  (recommended  $T_{j,op} = -40 \dots +150^\circ\text{C}$ )
- MiniSKiiP "Technical Explanations" and "Mounting Instructions" are part of the data sheet. Please refer to both documents for further information

Absolute Maximum Ratings				
Symbol	Conditions		Values	Unit
<b>Rectifier - Diode</b>				
$V_{RRM}$	$T_j = 25^\circ\text{C}$		1600	V
$I_F$	$\lambda_{paste}=0.8\text{ W/(mK)}$	$T_s = 25^\circ\text{C}$	81	A
		$T_j = 150^\circ\text{C}$	60	A
$I_F$	$\lambda_{paste}=2.5\text{ W/(mK)}$	$T_s = 25^\circ\text{C}$	92	A
		$T_j = 150^\circ\text{C}$	68	A
$I_{FSM}$	$t_p = 10\text{ ms}$ $\sin 180^\circ$	$T_j = 25^\circ\text{C}$	700	A
		$T_j = 150^\circ\text{C}$	490	A
$i^2t$	$t_p = 10\text{ ms}$ $\sin 180^\circ$	$T_j = 25^\circ\text{C}$	2500	$\text{A}^2\text{s}$
		$T_j = 150^\circ\text{C}$	1200	$\text{A}^2\text{s}$
$T_j$			-40 ... 150	$^\circ\text{C}$
<b>Module</b>				
$I_{t(RMS)}$	$T_{terminal} = 80^\circ\text{C}$ , 20 A per spring		80	A
$T_{stg}$	module without TIM		-40 ... 125	$^\circ\text{C}$
$V_{isol}$	AC sinus 50 Hz, 1 min		2500	V

Characteristics						
Symbol	Conditions		min.	typ.	max.	Unit
<b>Inverter - IGBT</b>						
$V_{CE(sat)}$	$I_C = 50\text{ A}$ $V_{GE} = 15\text{ V}$ chipelevel	$T_j = 25^\circ\text{C}$	1.85	2.10		V
		$T_j = 150^\circ\text{C}$	2.20	2.40		V
$V_{CE0}$	chipelevel	$T_j = 25^\circ\text{C}$	0.80	0.90		V
		$T_j = 150^\circ\text{C}$	0.70	0.80		V
$r_{CE}$	$V_{GE} = 15\text{ V}$ chipelevel	$T_j = 25^\circ\text{C}$	21	24		$\text{m}\Omega$
		$T_j = 150^\circ\text{C}$	30	32		$\text{m}\Omega$
$V_{GE(th)}$	$V_{GE} = V_{CE}$ , $I_C = 2\text{ mA}$		5	5.8	6.5	V
$I_{CES}$	$V_{GE} = 0\text{ V}$ , $V_{CE} = 1200\text{ V}$ , $T_j = 25^\circ\text{C}$				1	$\text{mA}$
$C_{ies}$	$V_{CE} = 25\text{ V}$ $V_{GE} = 0\text{ V}$	$f = 1\text{ MHz}$	2.77			nF
$C_{oes}$		$f = 1\text{ MHz}$	0.21			nF
$C_{res}$		$f = 1\text{ MHz}$	0.16			nF
$Q_G$	$V_{GE} = -8\text{ V} \dots +15\text{ V}$		280			nC
$R_{Gint}$	$T_j = 25^\circ\text{C}$		4.0			$\Omega$
$t_{d(on)}$	$V_{CC} = 600\text{ V}$ $I_C = 50\text{ A}$	$T_j = 150^\circ\text{C}$	60			ns
$t_r$		$T_j = 150^\circ\text{C}$	35			ns
$E_{on}$	$R_{G\ off} = 15\ \Omega$	$T_j = 150^\circ\text{C}$	6			mJ
$t_{d(off)}$	$di/dt_{on} = 1700\text{ A}/\mu\text{s}$	$T_j = 150^\circ\text{C}$	370			ns
$t_f$	$di/dt_{off} = 650\text{ A}/\mu\text{s}$	$T_j = 150^\circ\text{C}$	60			ns
$E_{off}$	$V_{GE} = +15/-15\text{ V}$		4.7			mJ
$R_{th(j-s)}$	per IGBT, $\lambda_{paste}=0.8\text{ W/(mK)}$		0.71			K/W
$R_{th(j-s)}$	per IGBT, $\lambda_{paste}=2.5\text{ W/(mK)}$		0.57			K/W

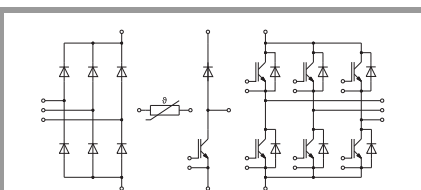

NAB

# SKiiP 35NAB12T4V1

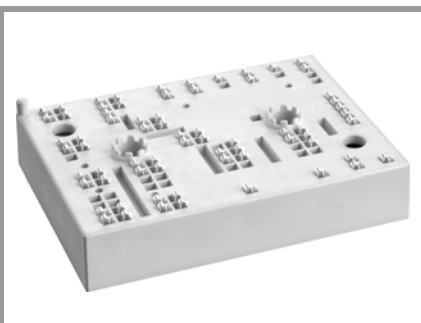

MiniSKiiP® 3

## Converter-Inverter-Brake (CIB)

### SKiiP 35NAB12T4V1

#### Features\*

- Trench 4 IGBTs
- Robust and soft switching freewheeling diodes in CAL technology
- Highly reliable spring contacts for electrical connections
- UL recognized: File no. E63532

#### Typical Applications

- Inverter up to 26 kVA
- Typical motor power 15 kW

#### Remarks

- Max. case temperature limited to  $T_C=125^\circ\text{C}$
- Product reliability results valid for  $T_j \leq 150^\circ\text{C}$  (recommended  $T_{j,op} = -40 \dots +150^\circ\text{C}$ )
- MiniSKiiP "Technical Explanations" and "Mounting Instructions" are part of the data sheet. Please refer to both documents for further information

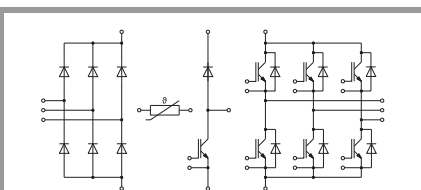

NAB

Characteristics						
Symbol	Conditions		min.	typ.	max.	Unit
<b>Chopper - IGBT</b>						
$V_{CE(sat)}$	$I_C = 50\text{ A}$ $V_{GE} = 15\text{ V}$ chipelevel	$T_j = 25^\circ\text{C}$	1.85	2.10		V
		$T_j = 150^\circ\text{C}$	2.20	2.40		V
$V_{CE0}$	chipelevel	$T_j = 25^\circ\text{C}$	0.80	0.90		V
		$T_j = 150^\circ\text{C}$	0.70	0.80		V
$r_{CE}$	$V_{GE} = 15\text{ V}$ chipelevel	$T_j = 25^\circ\text{C}$	21	24		m $\Omega$
		$T_j = 150^\circ\text{C}$	30	32		m $\Omega$
$V_{GE(th)}$	$V_{GE} = V_{CE}, I_C = 2\text{ mA}$		5	5.8	6.5	V
$I_{CES}$	$V_{GE} = 0\text{ V}, V_{CE} = 1200\text{ V}, T_j = 25^\circ\text{C}$				1	mA
$C_{ies}$	$V_{CE} = 25\text{ V}$ $V_{GE} = 0\text{ V}$	$f = 1\text{ MHz}$	2.77			nF
$C_{oes}$		$f = 1\text{ MHz}$	0.21			nF
$C_{res}$		$f = 1\text{ MHz}$	0.16			nF
$Q_G$	$V_{GE} = -8\text{ V} \dots +15\text{ V}$		280			nC
$R_{Gint}$	$T_j = 25^\circ\text{C}$		4.0			$\Omega$
$t_{d(on)}$	$V_{CC} = 600\text{ V}$ $I_C = 50\text{ A}$	$T_j = 150^\circ\text{C}$	60			ns
$t_r$	$R_{G\ on} = 15\ \Omega$ $R_{G\ off} = 15\ \Omega$	$T_j = 150^\circ\text{C}$	35			ns
$E_{on}$		$T_j = 150^\circ\text{C}$	6			mJ
$t_{d(off)}$		$T_j = 150^\circ\text{C}$	370			ns
$t_f$		$T_j = 150^\circ\text{C}$	60			ns
$E_{off}$	$V_{GE} = +15/-15\text{ V}$	$T_j = 150^\circ\text{C}$	4.7			mJ
$R_{th(j-s)}$	per IGBT, $\lambda_{paste}=0.8\text{ W}/(\text{mK})$		0.71			K/W
$R_{th(j-s)}$	per IGBT, $\lambda_{paste}=2.5\text{ W}/(\text{mK})$		0.57			K/W
<b>Inverse - Diode</b>						
$V_F = V_{EC}$	$I_F = 50\text{ A}$ $V_{GE} = 0\text{ V}$ chipelevel	$T_j = 25^\circ\text{C}$	2.22	2.54		V
		$T_j = 150^\circ\text{C}$	2.18	2.50		V
$V_{F0}$	chipelevel	$T_j = 25^\circ\text{C}$	1.30	1.50		V
		$T_j = 150^\circ\text{C}$	0.90	1.10		V
$r_F$	chipelevel	$T_j = 25^\circ\text{C}$	18	21		m $\Omega$
		$T_j = 150^\circ\text{C}$	26	28		m $\Omega$
$I_{RRM}$	$I_F = 50\text{ A}$	$T_j = 150^\circ\text{C}$	45			A
$Q_{rr}$	$di/dt_{off} = 1400\text{ A}/\mu\text{s}$ $V_{GE} = -15\text{ V}$	$T_j = 150^\circ\text{C}$	8.6			$\mu\text{C}$
$E_{rr}$	$V_{CC} = 600\text{ V}$	$T_j = 150^\circ\text{C}$	3.4			mJ
$R_{th(j-s)}$	per Diode, $\lambda_{paste}=0.8\text{ W}/(\text{mK})$		0.95			K/W
$R_{th(j-s)}$	per Diode, $\lambda_{paste}=2.5\text{ W}/(\text{mK})$		0.79			K/W
<b>Freewheeling - Diode</b>						
$V_F = V_{EC}$	$I_F = 50\text{ A}$ $V_{GE} = 0\text{ V}$ chipelevel	$T_j = 25^\circ\text{C}$	2.22	2.54		V
		$T_j = 150^\circ\text{C}$	2.18	2.50		V
$V_{F0}$	chipelevel	$T_j = 25^\circ\text{C}$	1.30	1.50		V
		$T_j = 150^\circ\text{C}$	0.90	1.10		V
$r_F$	chipelevel	$T_j = 25^\circ\text{C}$	18	21		m $\Omega$
		$T_j = 150^\circ\text{C}$	26	28		m $\Omega$
$I_{RRM}$	$I_F = 50\text{ A}$	$T_j = 150^\circ\text{C}$	45			A
$Q_{rr}$	$di/dt_{off} = 1400\text{ A}/\mu\text{s}$ $V_{GE} = -15\text{ V}$	$T_j = 150^\circ\text{C}$	8.6			$\mu\text{C}$
$E_{rr}$	$V_{CC} = 600\text{ V}$	$T_j = 150^\circ\text{C}$	3.4			mJ
$R_{th(j-s)}$	per Diode, $\lambda_{paste}=0.8\text{ W}/(\text{mK})$		0.95			K/W
$R_{th(j-s)}$	per Diode, $\lambda_{paste}=2.5\text{ W}/(\text{mK})$		0.79			K/W

# SKiiP 35NAB12T4V1

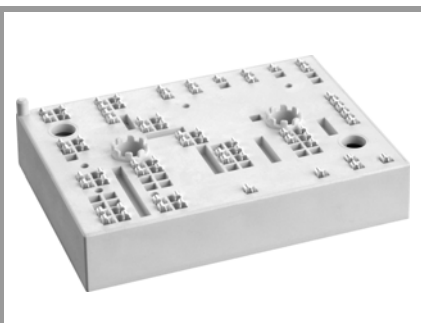

MiniSKiiP® 3

## Converter-Inverter-Brake (CIB)

### SKiiP 35NAB12T4V1

#### Features\*

- Trench 4 IGBTs
- Robust and soft switching freewheeling diodes in CAL technology
- Highly reliable spring contacts for electrical connections
- UL recognized: File no. E63532

#### Typical Applications

- Inverter up to 26 kVA
- Typical motor power 15 kW

#### Remarks

- Max. case temperature limited to  $T_C=125^\circ\text{C}$
- Product reliability results valid for  $T_j \leq 150^\circ\text{C}$  (recommended  $T_{j,op} = -40 \dots +150^\circ\text{C}$ )
- MiniSKiiP "Technical Explanations" and "Mounting Instructions" are part of the data sheet. Please refer to both documents for further information

Characteristics						
Symbol	Conditions		min.	typ.	max.	Unit
<b>Rectifier - Diode</b>						
$V_F = V_{EC}$	chiplevel	$T_j = 25^\circ\text{C}$		1.00	1.21	V
		$T_j = 125^\circ\text{C}$		0.90	1.10	V
$V_{F0}$	chiplevel	$T_j = 25^\circ\text{C}$		0.88	0.98	V
		$T_j = 125^\circ\text{C}$		0.73	0.83	V
$r_F$	chiplevel	$T_j = 25^\circ\text{C}$		4.8	9.2	m $\Omega$
		$T_j = 125^\circ\text{C}$		6.8	11	m $\Omega$
$I_R$	$T_j = 145^\circ\text{C}, V_{RRM}$				1.1	mA
$R_{th(j-s)}$	per Diode, $\lambda_{paste}=0.8 \text{ W/(mK)}$			0.9		K/W
$R_{th(j-s)}$	per Diode, $\lambda_{paste}=2.5 \text{ W/(mK)}$			0.75		K/W
<b>Module</b>						
$M_s$	to heat sink		2		2.5	Nm
$w$				82		g
$L_{CE}$				-		nH
<b>Temperature Sensor</b>						
$R_{100}$	$T_r=100^\circ\text{C} (R_{25}=1000\Omega)$			1670 $\pm$ 3%		$\Omega$
$R_{(T)}$	$R_{(T)}=1000\Omega[1+A(T-25^\circ\text{C})+B(T-25^\circ\text{C})^2]$ , $A = 7.635 \cdot 10^{-3} \text{ }^\circ\text{C}^{-1}$ , $B = 1.731 \cdot 10^{-5} \text{ }^\circ\text{C}^{-2}$					

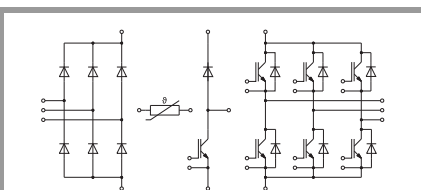

NAB

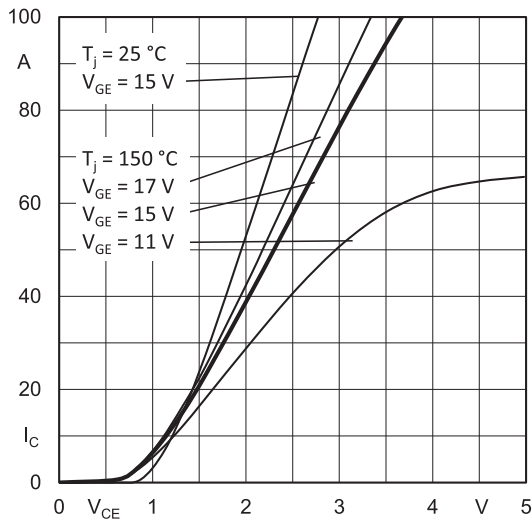

Fig. 1: Typ. output characteristic

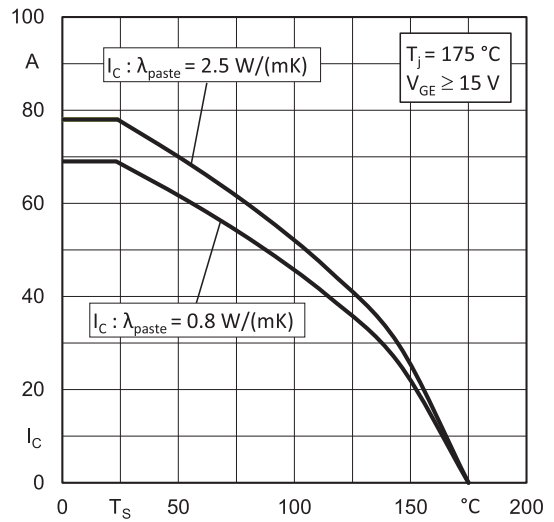

Fig. 2: Typ. rated current vs. temperature  $I_c = f(T_s)$

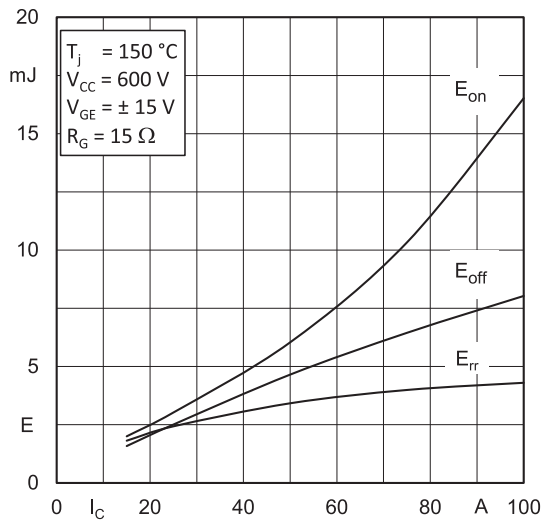

Fig. 3: Typ. turn-on /-off energy =  $f(I_c)$

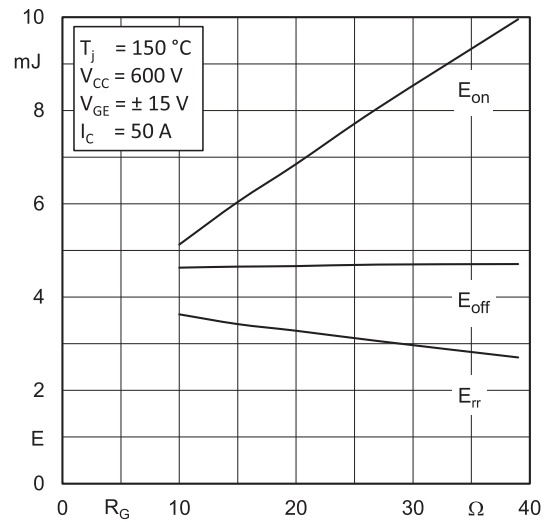

Fig. 4: Typ. turn-on /-off energy =  $f(R_G)$

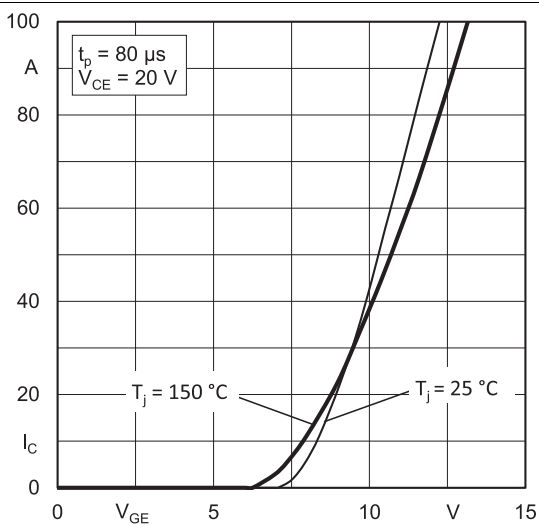

Fig. 5: Typ. transfer characteristic

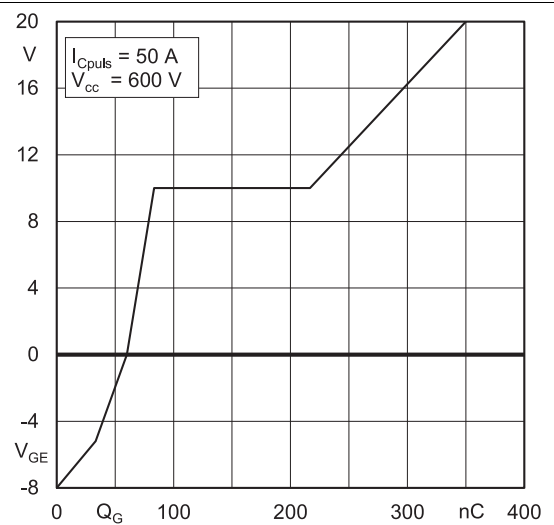

Fig. 6: Typ. gate charge characteristic

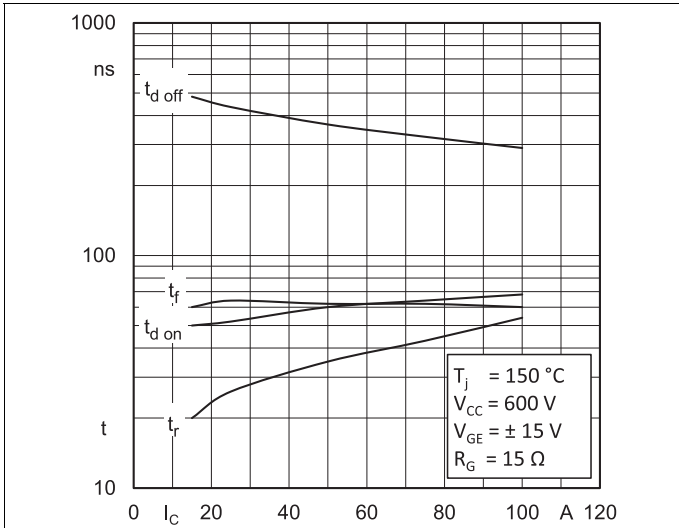

Fig. 7: Typ. switching times vs.  $I_C$

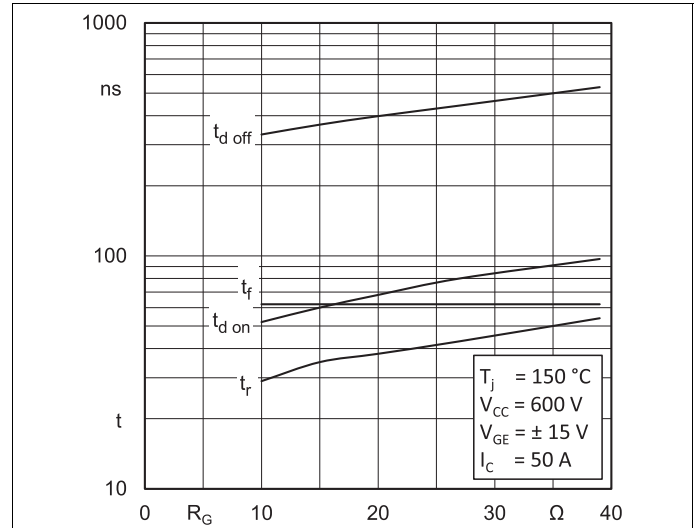

Fig. 8: Typ. switching times vs. gate resistor  $R_G$

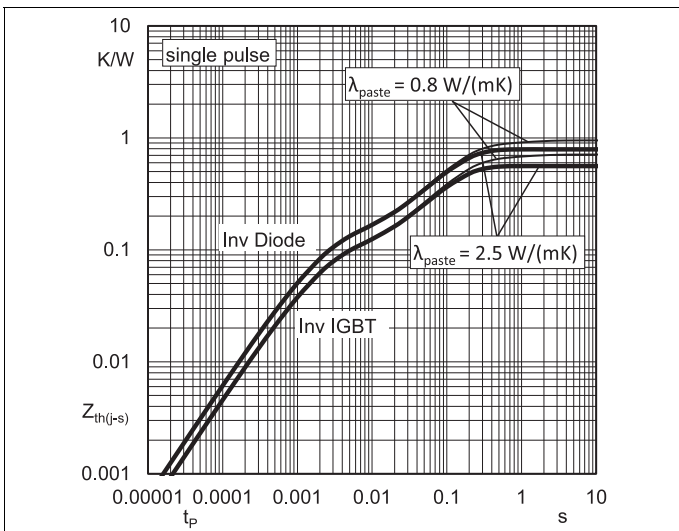

Fig. 9: Typ. transient thermal impedance

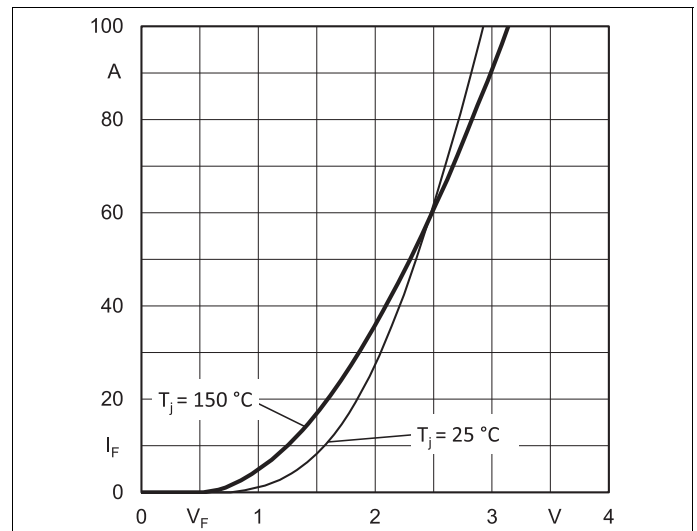

Fig. 10: Typ. CAL diode forward characteristic

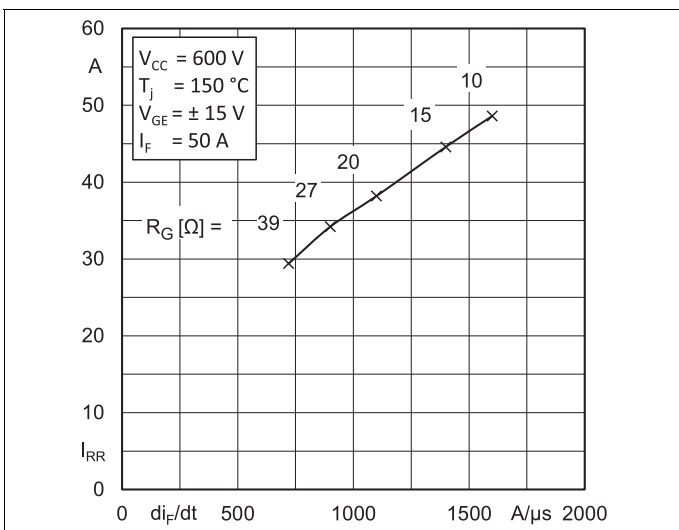

Fig. 11: Typ. CAL diode peak reverse recovery current

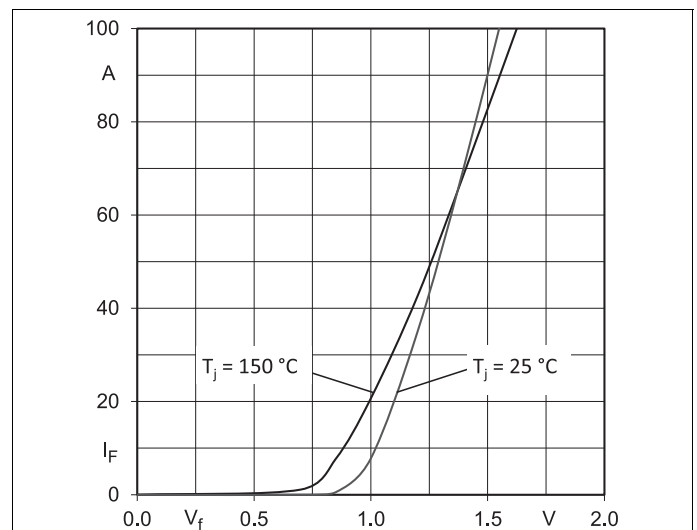
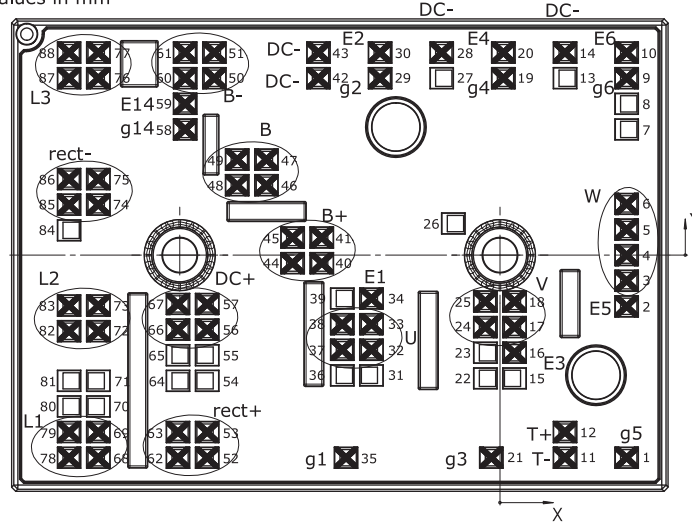

Fig. 12: Typ. input bridge forward characteristic

# SKiP 35NAB12T4V1

Pin out													
Pin	X	Y	Function	Pin	X	Y	Function	Pin	X	Y	Function	Pin	Y
1	15,83	-25,30	g5	31	-16,05	-15,02		61	-39,33	25,30	B-		
2	15,83	-6,40	E5	32	-16,05	-11,82	U	62	-40,23	-25,30	rect+		
3	15,83	-3,20	W	33	-16,05	-8,62	U	63	-40,23	-22,10	rect+		
4	15,83	0	W	34	-16,05	-5,42	E1	64	-40,23	-15,70			
5	15,83	3,20	W	35	-19,23	-25,30	g1	65	-40,23	-12,50			
6	15,83	6,40	W	36	-19,70	-15,02		66	-40,23	-9,30	DC+		
7	15,83	15,70		37	-19,70	-11,82	U	67	-40,23	-6,10	DC+		
8	15,83	18,90		38	-19,70	-8,62	U	68	-50,18	-25,30	L1		
9	15,83	22,10	g6	39	-19,70	-5,42		69	-50,18	-22,10	L1		
10	15,83	25,30	E6	40	-22,26	-1,00	B+	70	-50,18	-18,90			
11	8,13	-25,30	T-	41	-22,26	2,20	B+	71	-50,18	-15,70			
12	8,13	-22,10	T+	42	-22,68	22,10	DC-	72	-50,18	-9,50	L2		
13	8,13	22,10		43	-22,68	25,30	DC-	73	-50,18	-6,30	L2		
14	8,13	25,30	DC-	44	-25,91	-1,00	B+	74	-50,18	6,30	rect-		
15	1,83	-15,39		45	-25,91	2,20	B+	75	-50,18	9,50	rect-		
16	1,83	-12,19	E3	46	-29,18	8,74	B	76	-50,18	22,10	L3		
17	1,83	-8,99	V	47	-29,18	11,94	B	77	-50,18	25,30	L3		
18	1,83	-5,79	V	48	-32,83	8,74	B	78	-53,83	-25,30	L1		
19	0,43	22,10	g4	49	-32,83	11,94	B	79	-53,83	-22,10	L1		
20	0,43	25,30	E4	50	-35,68	22,10	B-	80	-53,83	-18,90			
21	-1,08	-25,30	g3	51	-35,68	25,30	B-	81	-53,83	-15,70			
22	-1,83	-15,39		52	-36,58	-25,30	rect+	82	-53,83	-9,50	L2		
23	-1,83	-12,19		53	-36,58	-22,10	rect+	83	-53,83	-6,30	L2		
24	-1,83	-8,99	V	54	-36,58	-15,70		84	-53,83	3,10			
25	-1,83	-5,79	V	55	-36,58	-12,50		85	-53,83	6,30	rect-		
26	-5,83	3,95		56	-36,58	-9,30	DC+	86	-53,83	9,50	rect-		
27	-7,28	22,10		57	-36,58	-6,10	DC+	87	-53,83	22,10	L3		
28	-7,28	25,30	DC-	58	-39,33	15,70	g14	88	-53,83	25,30	L3		
29	-14,98	22,10	g2	59	-39,33	18,90	E14						
30	-14,98	25,30	E2	60	-39,33	22,10	B-						

all values in mm



Pinout and Dimensions

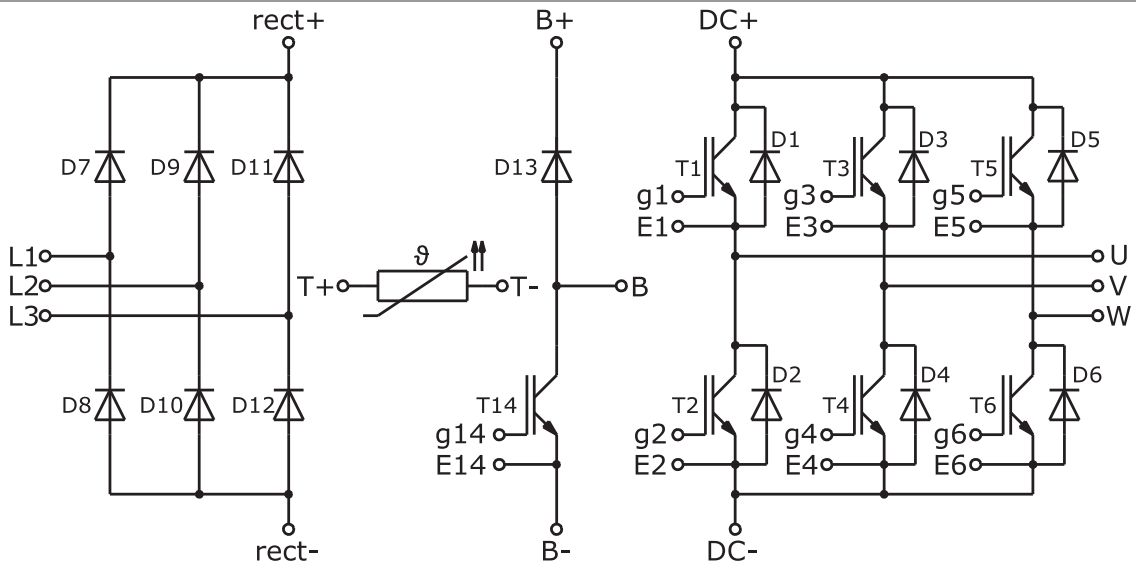

Pinout

This is an electrostatic discharge sensitive device (ESDS) due to international standard IEC 61340.

## **\*IMPORTANT INFORMATION AND WARNINGS**

The specifications of SEMIKRON products may not be considered as guarantee or assurance of product characteristics ("Beschaffenheitsgarantie"). The specifications of SEMIKRON products describe only the usual characteristics of products to be expected in typical applications, which may still vary depending on the specific application. Therefore, products must be tested for the respective application in advance. Application adjustments may be necessary. The user of SEMIKRON products is responsible for the safety of their applications embedding SEMIKRON products and must take adequate safety measures to prevent the applications from causing a physical injury, fire or other problem if any of SEMIKRON products become faulty. The user is responsible to make sure that the application design is compliant with all applicable laws, regulations, norms and standards. Except as otherwise explicitly approved by SEMIKRON in a written document signed by authorized representatives of SEMIKRON, SEMIKRON products may not be used in any applications where a failure of the product or any consequences of the use thereof can reasonably be expected to result in personal injury. No representation or warranty is given and no liability is assumed with respect to the accuracy, completeness and/or use of any information herein, including without limitation, warranties of non-infringement of intellectual property rights of any third party. SEMIKRON does not assume any liability arising out of the applications or use of any product; neither does it convey any license under its patent rights, copyrights, trade secrets or other intellectual property rights, nor the rights of others. SEMIKRON makes no representation or warranty of non-infringement or alleged non-infringement of intellectual property rights of any third party which may arise from applications. Due to technical requirements our products may contain dangerous substances. For information on the types in question please contact the nearest SEMIKRON sales office. This document supersedes and replaces all information previously supplied and may be superseded by updates. SEMIKRON reserves the right to make changes.