

SKM 145GB066D

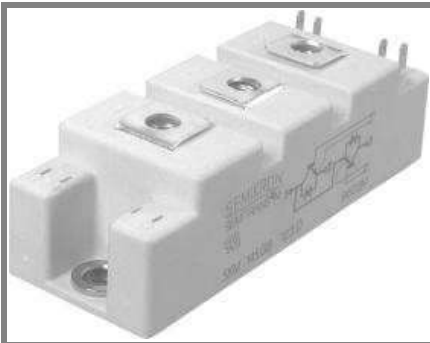

SEMITRANS® 2

Trench IGBT Modules

SKM 145GB066D

Features

- Trench = Trenchgate technology
- $V_{CE(sat)}$ with positive temperature coefficient
- High short circuit capability, self limiting to $6 \times I_C$

Typical Applications*

- AC inverter Drives
- UPS
- Electronic welders

Remarks

- Case temperature limited to $T_C = 125^\circ\text{C}$ max, recomm. $T_{op} = -40 \dots +150^\circ\text{C}$, product rel. results valid for $T_j \leq 150^\circ\text{C}$
- SC data: $t_p \leq 6 \text{ s}$; $V_{GE} \leq 15\text{V}$; $T_j = 150^\circ\text{C}$; $V_{CC} \leq 360\text{V}$, use of soft R_G necessary!
- Take care of over-voltage caused by stray induct.

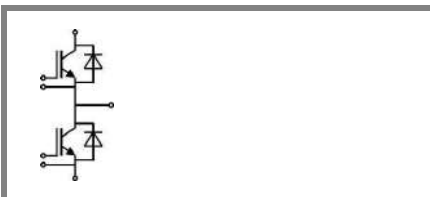

GB

Absolute Maximum Ratings		$T_{case} = 25^\circ\text{C}$, unless otherwise specified		
Symbol	Conditions	Values	Units	
IGBT				
V_{CES}	$T_j = 25^\circ\text{C}$	600	V	
I_C	$T_j = 175^\circ\text{C}$	$T_c = 25^\circ\text{C}$	195	A
		$T_c = 80^\circ\text{C}$	150	A
I_{CRM}	$I_{CRM} = 2 \times I_{Cnom}$	300	A	
V_{GES}		± 20	V	
t_{psc}	$V_{CC} = 360 \text{ V}$; $V_{GE} \leq 15 \text{ V}$; $T_j = 150^\circ\text{C}$ $V_{CES} < 600 \text{ V}$	6	s	
Inverse Diode				
I_F	$T_j = 175^\circ\text{C}$	$T_c = 25^\circ\text{C}$	150	A
		$T_c = 80^\circ\text{C}$	100	A
I_{FRM}	$I_{FRM} = 2 \times I_{Fnom}$	300	A	
I_{FSM}	$t_p = 10 \text{ ms}$; sin.	$T_j = 175^\circ\text{C}$	880	A
Module				
$I_{t(RMS)}$		200	A	
T_{vj}		-40 ... +175	$^\circ\text{C}$	
T_{stg}		-40 ... +125	$^\circ\text{C}$	
V_{isol}	AC, 1 min.	4000	V	

Characteristics		$T_{case} = 25^\circ\text{C}$, unless otherwise specified			
Symbol	Conditions	min.	typ.	max.	Units
IGBT					
$V_{GE(th)}$	$V_{GE} = V_{CE}$; $I_C = 2,4 \text{ mA}$	5	5,8	6,5	V
I_{CES}	$V_{GE} = 0 \text{ V}$, $V_{CE} = V_{CES}$	$T_j = 25^\circ\text{C}$	0,08	0,25	mA
		$T_j = 150^\circ\text{C}$	0,85	0,9	V
V_{CE0}					
r_{CE}	$V_{GE} = 15 \text{ V}$	$T_j = 25^\circ\text{C}$	3,7	6	$\text{m}\Omega$
		$T_j = 150^\circ\text{C}$	5,7	8	$\text{m}\Omega$
$V_{CE(sat)}$	$I_{Cnom} = 150 \text{ A}$, $V_{GE} = 15 \text{ V}$	$T_j = 25^\circ\text{C}_{chiplev.}$	1,45	1,9	V
		$T_j = 150^\circ\text{C}_{chiplev.}$	1,7	2,1	V
C_{res}	$V_{CE} = 25$, $V_{GE} = 0 \text{ V}$	$f = 1 \text{ MHz}$	9,25		nF
C_{oes}			0,6		nF
C_{res}			0,28		nF
Q_G	$V_{GE} = -8\text{V} \dots +15\text{V}$		1100		nC
R_{Gint}	$T_j = ^\circ\text{C}$		2		Ω
$t_{d(on)}$	$R_{Gon} = 4,3 \Omega$	$V_{CC} = 300\text{V}$ $I_C = 150\text{A}$	150		ns
t_r			52		ns
E_{on}	$R_{Goff} = 4,3 \Omega$	$T_j = 150^\circ\text{C}$ $V_{GE} = -8/+15\text{V}$	8,5		mJ
$t_{d(off)}$			490		ns
t_f			46		ns
E_{off}			5,5		mJ
$R_{th(j-c)}$	per IGBT			0,3	K/W

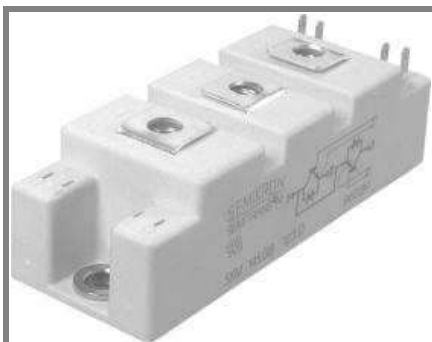

SEMITRANS® 2

Trench IGBT Modules

SKM 145GB066D

Features

- Trench = Trenchgate technology
- $V_{CE(sat)}$ with positive temperature coefficient
- High short circuit capability, self limiting to $6 \times I_C$

Typical Applications*

- AC inverter Drives
- UPS
- Electronic welders

Remarks

- Case temperature limited to $T_C = 125^\circ\text{C}$ max, recomm. $T_{op} = -40 \dots +150^\circ\text{C}$, product rel. results valid for $T_j \leq 150^\circ\text{C}$
- SC data: $t_p \leq 6 \text{ s}$; $V_{GE} \leq 15\text{V}$; $T_j = 150^\circ\text{C}$; $V_{CC} \leq 360\text{V}$, use of soft R_G necessary!
- Take care of over-voltage caused by stray induct.

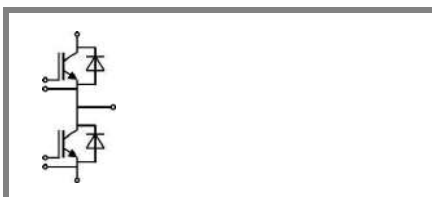

GB

Characteristics		min.	typ.	max.	Units
Symbol	Conditions				
Inverse Diode					
$V_F = V_{EC}$	$I_{Fnom} = 150 \text{ A}; V_{GE} = 0 \text{ V}$		1,4	1,6	V
					V
					V
V_{F0}			0,95	1	V
r_F			3	4	mΩ
I_{RRM}	$I_F = 150 \text{ A}$		90		A
Q_{rr}	$di/dt = 2100 \text{ A/ s}$		20		C
E_{rr}	$V_{GE} = -8 \text{ V}; V_{CC} = 300 \text{ V}$		3,5		mJ
$R_{th(j-c)D}$	per diode			0,5	K/W
Module					
L_{CE}				30	nH
R_{CC+EE}	res., terminal-chip	$T_{case} = 25^\circ\text{C}$	0,75		mΩ
		$T_{case} = 125^\circ\text{C}$	1		mΩ
$R_{th(c-s)}$	per module			0,05	K/W
M_s	to heat sink M6		3	5	Nm
M_t	to terminals M5		2,5	5	Nm
w				150	g

This is an electrostatic discharge sensitive device (ESDS), international standard IEC 60747-1, Chapter IX.

* The specifications of our components may not be considered as an assurance of component characteristics. Components have to be tested for the respective application. Adjustments may be necessary. The use of SEMIKRON products in life support appliances and systems is subject to prior specification and written approval by SEMIKRON. We therefore strongly recommend prior consultation of our personal.

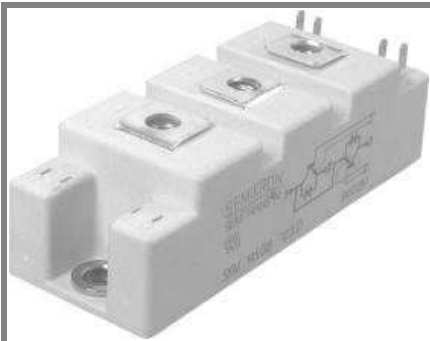

SEMITRANS® 2

Trench IGBT Modules

SKM 145GB066D

Features

- Trench = Trenchgate technology
- $V_{CE(sat)}$ with positive temperature coefficient
- High short circuit capability, self limiting to $6 \times I_C$

Typical Applications*

- AC inverter Drives
- UPS
- Electronic welders

Remarks

- Case temperature limited to $T_C = 125^\circ\text{C}$ max, recomm. $T_{op} = -40 \dots +150^\circ\text{C}$, product rel. results valid for $T_j \leq 150^\circ\text{C}$
- SC data: $t_p \leq 6$ s; $V_{GE} \leq 15\text{V}$; $T_j = 150^\circ\text{C}$; $V_{cc} \leq 360\text{V}$, use of soft R_G necessary!
- Take care of over-voltage caused by stray induct.

Z_{th}		Conditions	Values	Units
Symbol				
$Z_{th(j-c)I}$				
$R_{\theta j-c}$	$i = 1$		220	mk/W
$R_{\theta j-c}$	$i = 2$		60	mk/W
$R_{\theta j-c}$	$i = 3$		16,5	mk/W
$R_{\theta j-c}$	$i = 4$		3,5	mk/W
$\tau_{\theta j-c}$	$i = 1$		0,0447	s
$\tau_{\theta j-c}$	$i = 2$		0,0223	s
$\tau_{\theta j-c}$	$i = 3$		0,0015	s
$\tau_{\theta j-c}$	$i = 4$		0,0002	s
Symbol				
$Z_{th(j-c)D}$				
$R_{\theta j-c}$	$i = 1$		330	mk/W
$R_{\theta j-c}$	$i = 2$		137	mk/W
$R_{\theta j-c}$	$i = 3$		28	mk/W
$R_{\theta j-c}$	$i = 4$		5	mk/W
$\tau_{\theta j-c}$	$i = 1$		0,05	s
$\tau_{\theta j-c}$	$i = 2$		0,0129	s
$\tau_{\theta j-c}$	$i = 3$		0,002	s
$\tau_{\theta j-c}$	$i = 4$		0,0002	s

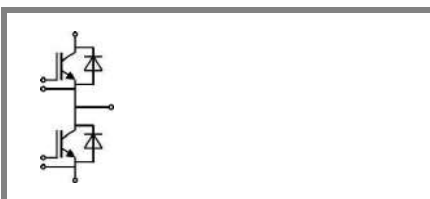

GB

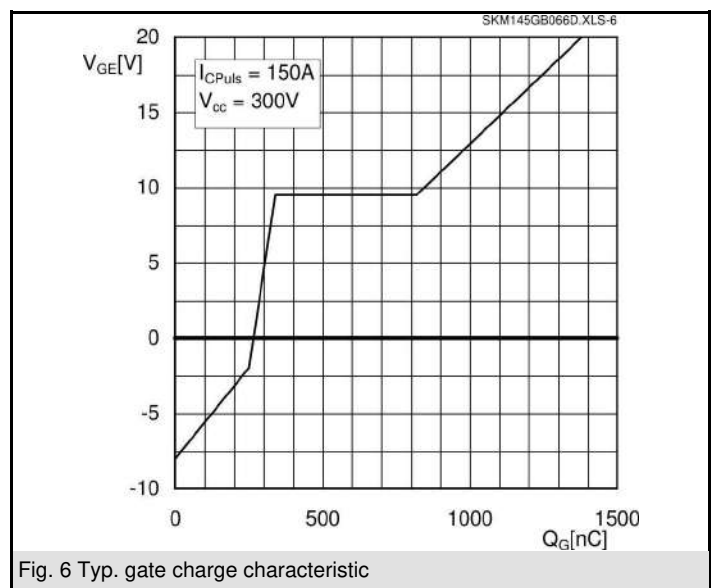
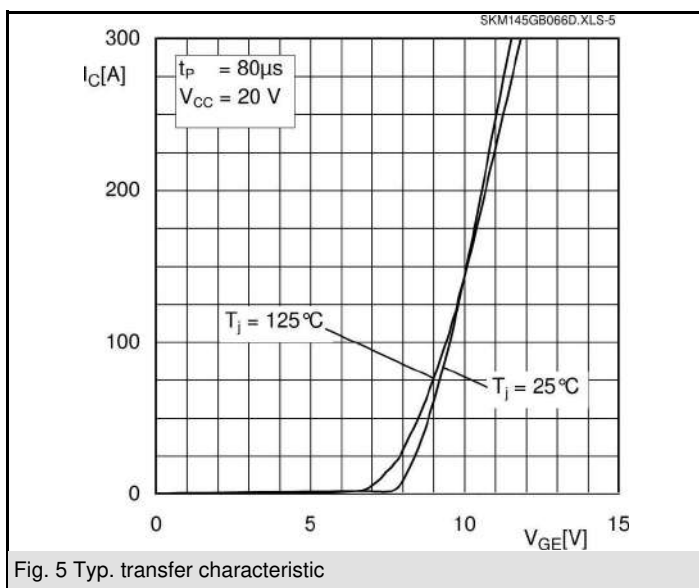
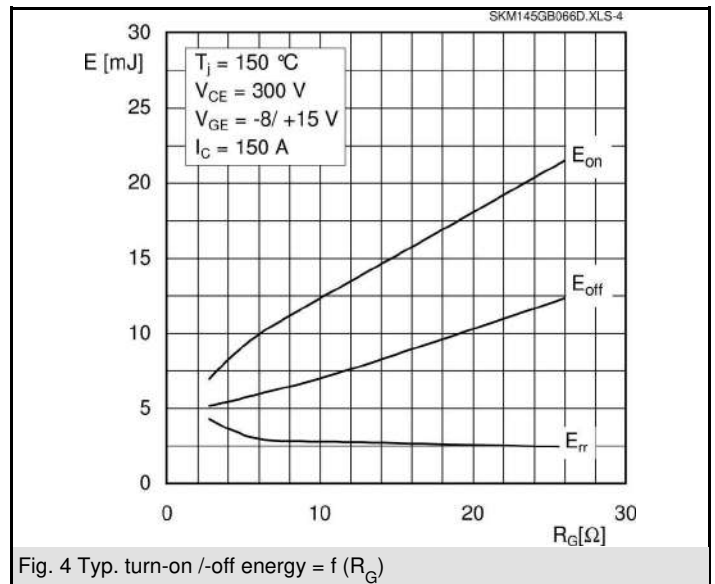
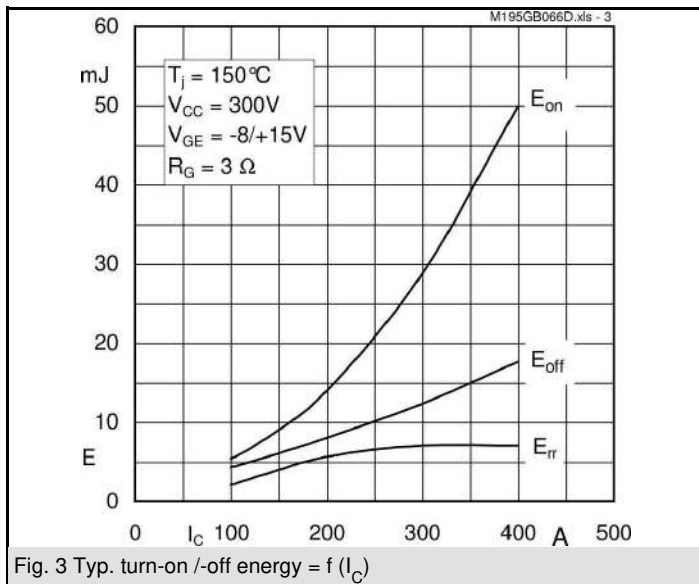
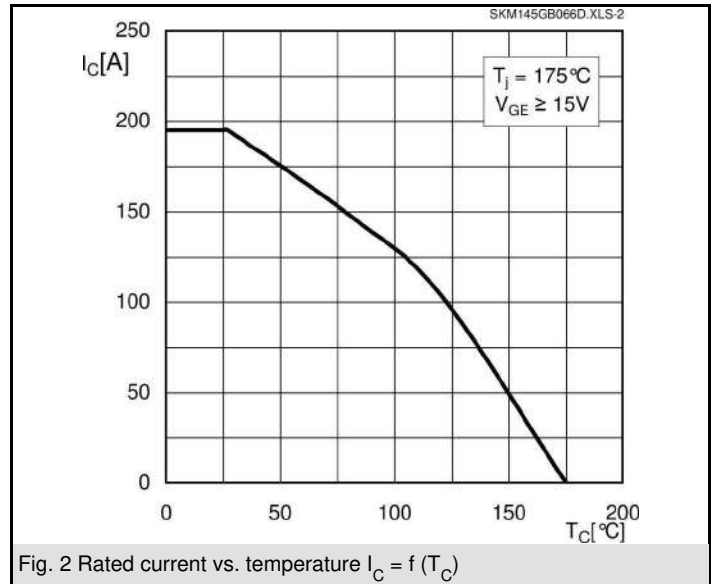
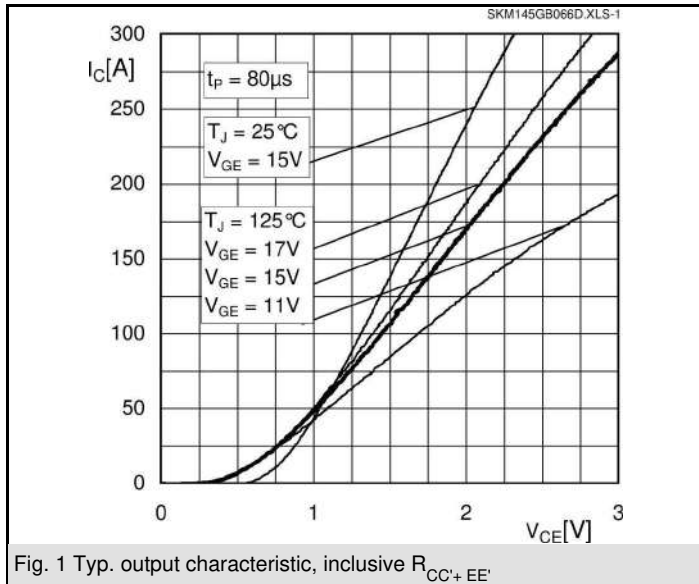

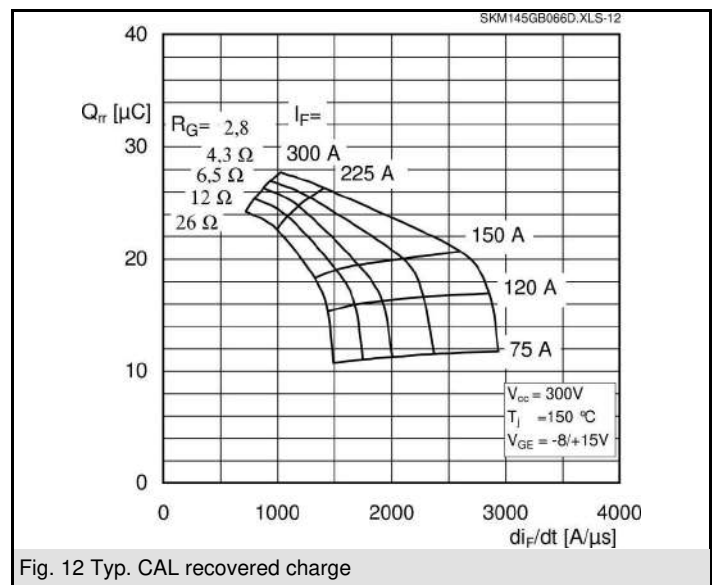
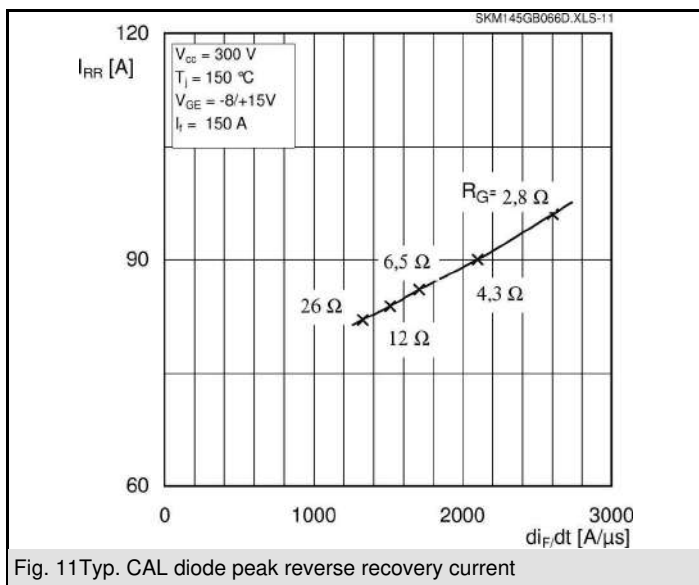
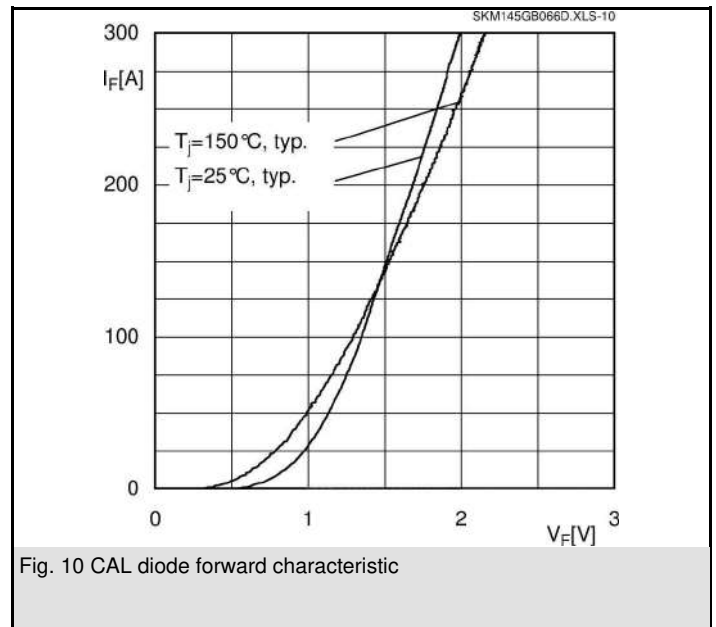
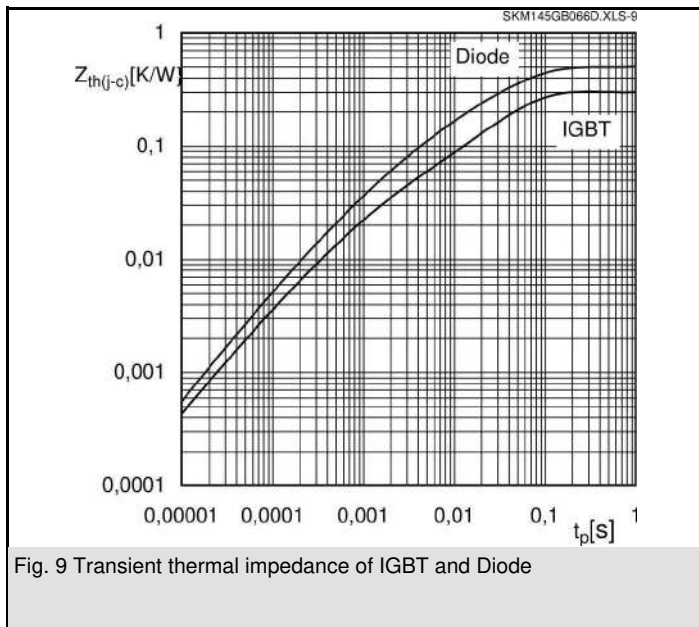
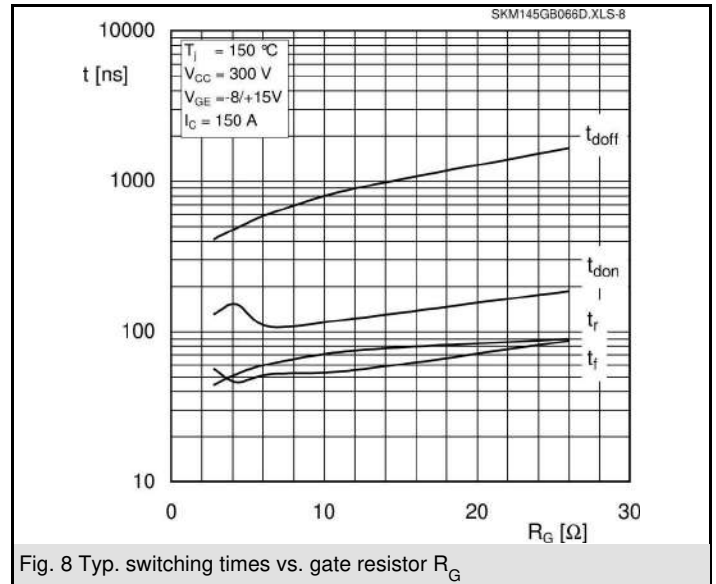
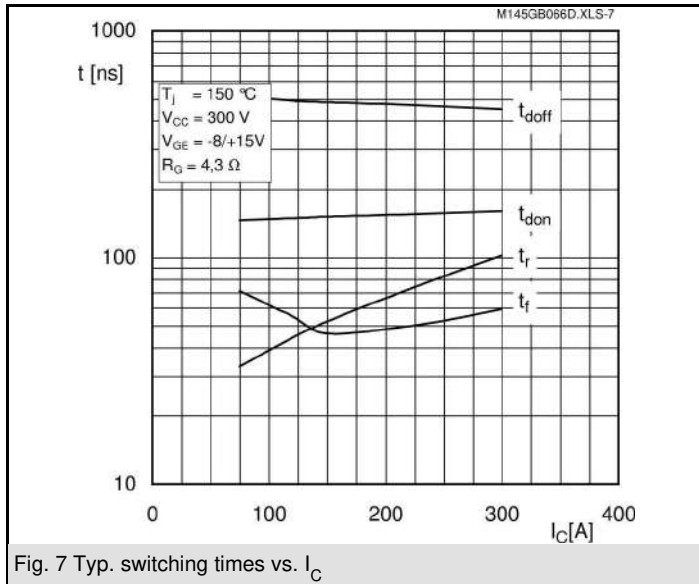

SKM 145GB066D

UL recognized, file no. E 63 532

CASED61

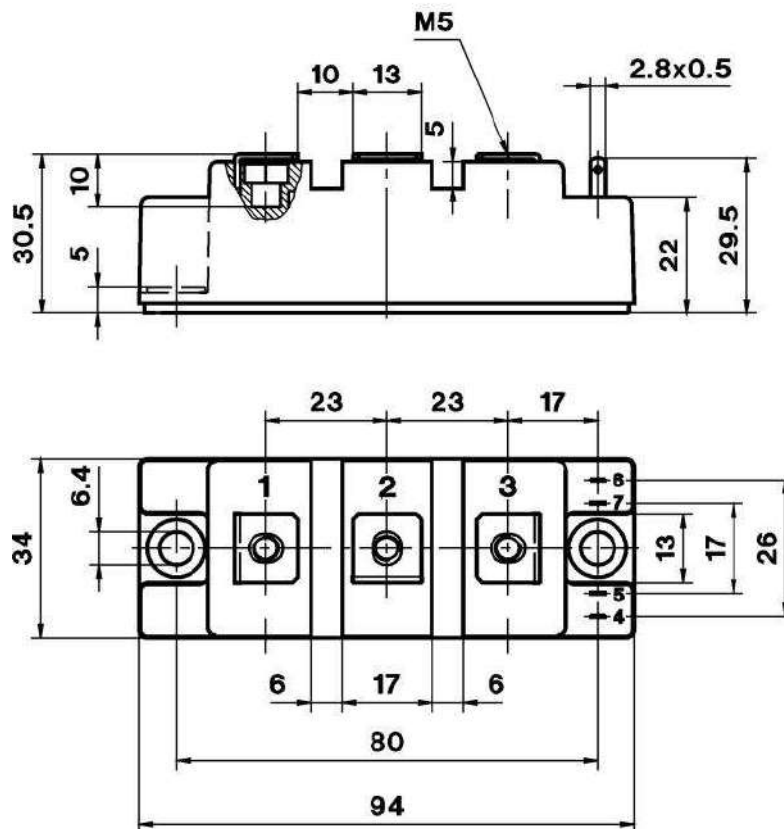

Case D 61

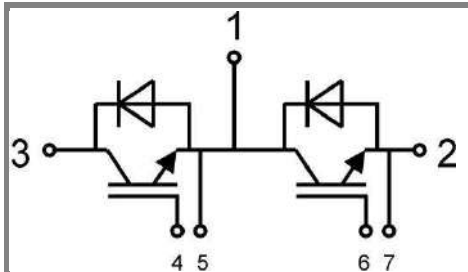

GB

Case D61