

PLC-RSC-230UC/21AU - Relay Module



2966294

<https://www.phoenixcontact.com/in/products/2966294>

Please be informed that the data shown in this PDF document is generated from our Online Catalog. Please find the complete data in the user documentation. Our General Terms of Use for Downloads are valid.



PLC-INTERFACE, consisting of PLC-BSC.../21 basic terminal block with screw connection and plug-in miniature relay with multi-layer gold contact, for mounting on DIN rail NS 35/7,5, 1 changeover contact, input voltage 230 V AC/220 V DC

Your advantages

- Slim design
- Efficient connection to system cabling using V8 adapter
- RT III sealed relay
- Safe isolation according to DIN EN 50178 between coil and contact
- Functional plug-in bridges
- Integrated input circuit and interference suppression circuit

Commercial Data

Item number	2966294
Packing unit	10 pc
Minimum order quantity	1 pc
Sales Key	CK6
Product Key	CK621B
Catalog Page	Page 365 (C-5-2019)
GTIN	4017918130787
Weight per Piece (including packing)	39.98 g
Weight per Piece (excluding packing)	33.65 g
Customs tariff number	85364900
Country of origin	IN

PLC-RSC-230UC/21AU - Relay Module



2966294

<https://www.phoenixcontact.com/in/products/2966294>

Set consists of

PLC-BSC-230UC/21 - Relay base

2966045

<https://www.phoenixcontact.com/in/products/2966045>



6.2 mm PLC basic terminal block with screw connection, without relay or solid-state relay, for mounting on DIN rail NS 35/7,5, 1 changeover contact, input voltage 230 V AC/DC

REL-MR- 60DC/21AU - Single relay

2961134

<https://www.phoenixcontact.com/in/products/2961134>

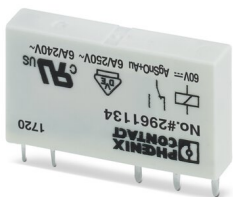

Plug-in miniature power relay, with multi-layer gold contact, 1 changeover contact, input voltage 60 V DC

Technical Data

Product properties

Product type	Relay Module
Product family	PLC-INTERFACE
Application	Universal
Operating mode	100% operating factor
Mechanical service life	2x 10 ⁷ cycles

Insulation characteristics

Overvoltage category	III
Pollution degree	3

Electrical properties

Maximum power dissipation for nominal condition	0.74 W
Test voltage (Winding/contact)	4 kV AC (50 Hz, 1 min., winding/contact)

Input data

Coil side

Nominal input voltage U_N	230 V AC
	220 V DC
Input voltage range	179.4 V AC ... 264.5 V AC (20 °C)
	171.6 V DC ... 253 V DC (20 °C)
Typical input current at U_N	3.2 mA (at U_N = 230 V AC)
	3 mA (at U_N = 220 V DC)
Typical response time	7 ms
Typical release time	15 ms
Protective circuit	Bridge rectifier; Bridge rectifier
Operating voltage display	Yellow LED

Output data

Switching

Contact type	1 changeover contact
Type of switch contact	Single contact
Drive and function	monostable
Drive (polarity)	polarized
Contact material	AgSnO, hard gold-plated
Maximum switching voltage	30 V AC
	36 V DC
Minimum switching voltage	100 mV (10 mA)
Limiting continuous current	50 mA
Maximum inrush current	50 mA
Min. switching current	1 mA (24 V)

PLC-RSC-230UC/21AU - Relay Module



2966294

<https://www.phoenixcontact.com/in/products/2966294>

Interrupting rating (ohmic load) max.	1.2 W (at 24 V DC)
Switching: when the gold layer is destroyed	
Note	the following values are applicable if a gold layer is destroyed
Maximum switching voltage	250 V AC/DC
Minimum switching voltage	5 V (at 100 mA)
Limiting continuous current	6 A
Min. switching current	10 mA (at 12 V)
Interrupting rating (ohmic load) max.	140 W (at 24 V DC)
	20 W (at 48 V DC)
	18 W (at 60 V DC)
	23 W (at 110 V DC)
	40 W (at 220 V DC)
Switching capacity	1500 VA (for 250 V AC)
	2 A (at 24 V, DC13)
	0.2 A (at 110 V, DC13)
	0.1 A (at 220 V, DC13)
	3 A (at 24 V, AC15)
	3 A (at 120 V, AC15)
	3 A (at 230 V, AC15)

Connection data

Connection method	Screw connection
Stripping length	8 mm
Screw thread	M3
Conductor cross section rigid	0.14 mm ² ... 2.5 mm ²
Conductor cross section flexible	0.14 mm ² ... 2.5 mm ²
	0.2 mm ² ... 2.5 mm ² (Single ferrule)
	2x 0.5 mm ² ... 1.5 mm ² (TWIN ferrule)
Conductor cross section AWG	26 ... 14
Tightening torque	0.6 Nm ... 0.8 Nm

Dimensions

Width	6.2 mm
Height	80 mm
Depth	94 mm

Material specifications

Flammability rating according to UL 94	V0 (Housing)
--	--------------

Environmental and real-life conditions

Ambient conditions

Degree of protection (Relay base)	IP20 (Relay base)
-----------------------------------	-------------------

PLC-RSC-230UC/21AU - Relay Module



2966294

<https://www.phoenixcontact.com/in/products/2966294>

Ambient temperature (operation)	-40 °C ... 55 °C
Ambient temperature (storage/transport)	-40 °C ... 85 °C

Approvals

Corrosive gas test

Identification	ISA-S71.04. G3 Harsh Group
	EN 60068-2-60

Standards and regulations

Standards/regulations	IEC 60947-5-1
-----------------------	---------------

Mounting

Mounting type	DIN rail mounting
Assembly instructions	in rows with zero spacing
Mounting position	any

Drawings

Diagram

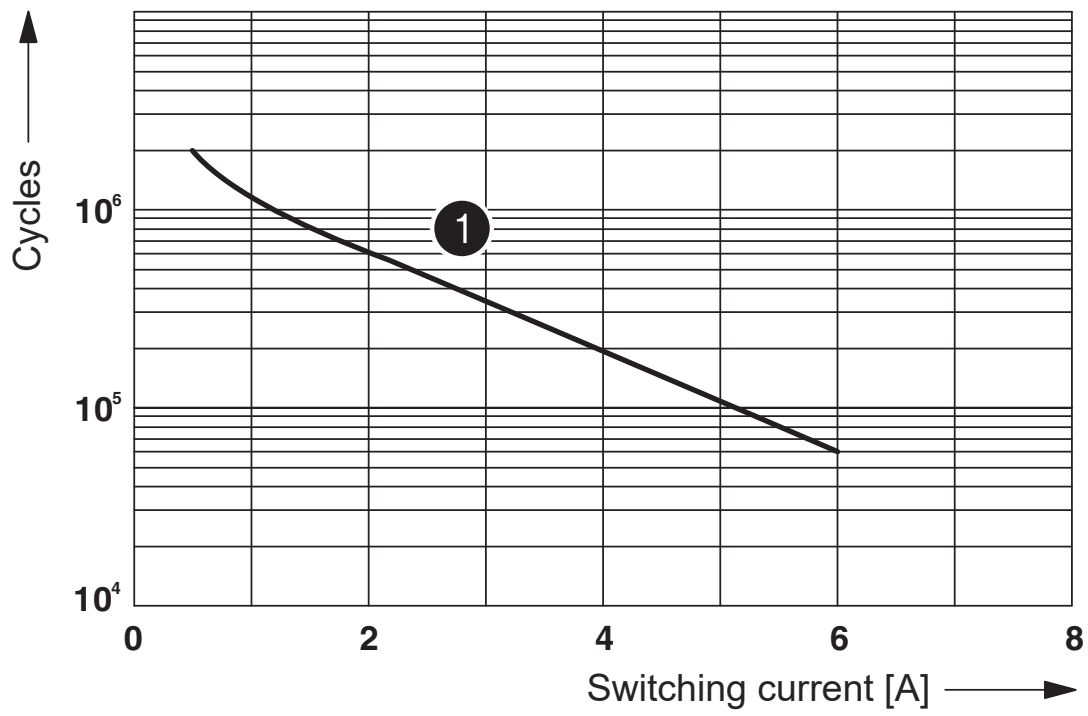

① 250 V AC, ohmic load

Electrical service life

Diagram

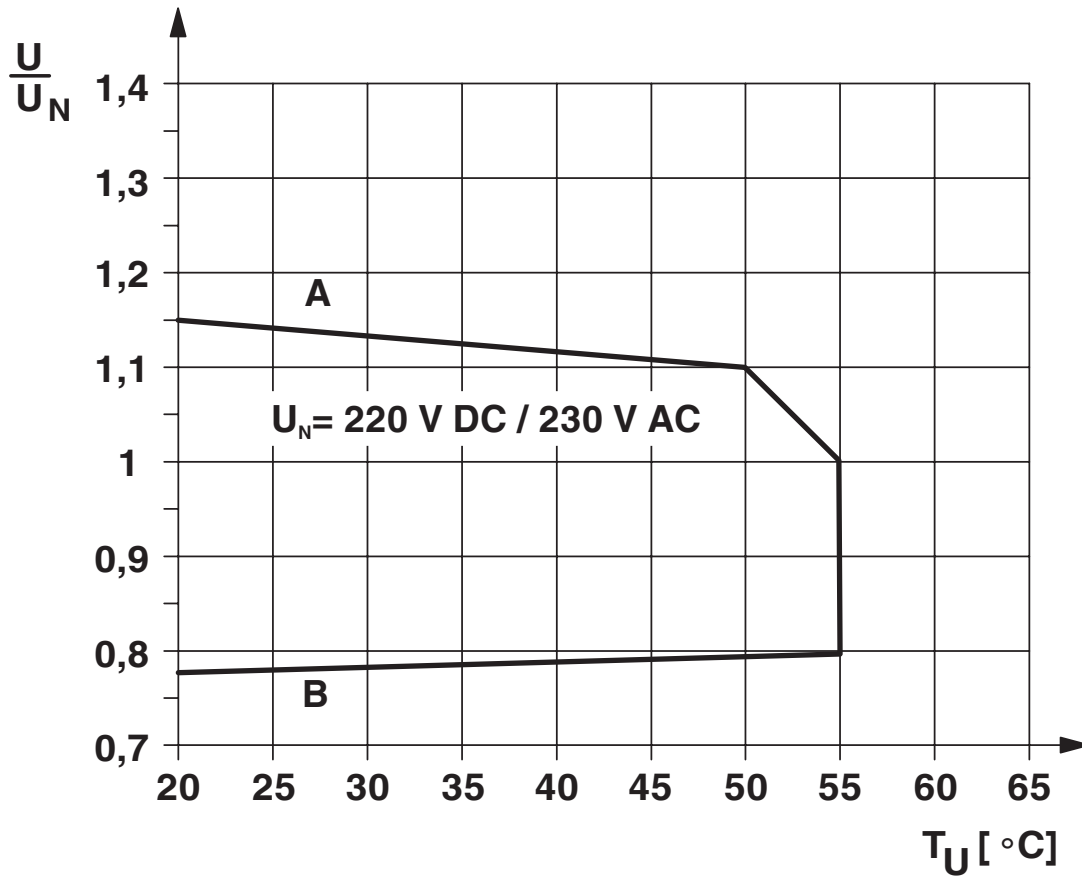

Curve A

Maximum permissible continuous voltage U_{max} with limiting continuous current on the contact side (see relevant technical data)

Curve B

Minimum permissible operate voltage U_{op} after pre-excitation (see relevant technical data)

PLC-RSC-230UC/21AU - Relay Module

2966294

<https://www.phoenixcontact.com/in/products/2966294>

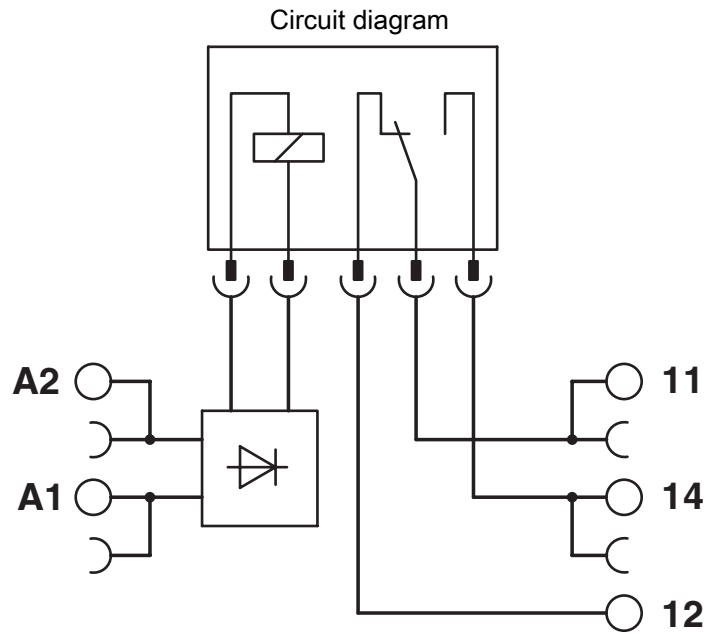

PLC-RSC-230UC/21AU - Relay Module



2966294

<https://www.phoenixcontact.com/in/products/2966294>

Approvals



cUL Recognized
Approval ID: FILE E 238705



UL Recognized
Approval ID: FILE E 238705



EAC
Approval ID: TR_TS_D_00573_c



DNV GL
Approval ID: TAE0000196



EAC
Approval ID: RU*C-DE.*08.B.00010



PRS
Approval ID: TE/2109/880590/16



UL Listed
Approval ID: FILE E 172140



cUL Listed
Approval ID: FILE E 172140



RC FRT
Approval ID: B.00094

PLC-RSC-230UC/21AU - Relay Module



2966294

<https://www.phoenixcontact.com/in/products/2966294>

Classifications

ECLASS

ECLASS-11.0	27371601
ECLASS-12.0	27371601
ECLASS-13.0	27371601

ETIM

ETIM 8.0	EC001437
----------	----------

UNSPSC

UNSPSC 21.0	39122300
-------------	----------

PLC-RSC-230UC/21AU - Relay Module



2966294

<https://www.phoenixcontact.com/in/products/2966294>

Environmental Product Compliance

REACH SVHC	Lead 7439-92-1
	Hexahydromethylphthalic anhydride
China RoHS	Environmentally Friendly Use Period = 50 years
	For information on hazardous substances, refer to the manufacturer's declaration available under "Downloads"

PLC-RSC-230UC/21AU - Relay Module

2966294

<https://www.phoenixcontact.com/in/products/2966294>

Accessories

 Note: Applying some accessories below might limit this product.

FBST 500-PLC RD - Continuous plug-in bridge

2966786

<https://www.phoenixcontact.com/in/products/2966786>



Continuous plug-in bridge, length: 500 mm, color: red

 Max. current carrying capacity: 32 A

FBST 500-PLC BU - Continuous plug-in bridge

2966692

<https://www.phoenixcontact.com/in/products/2966692>

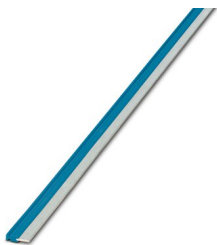

Continuous plug-in bridge, length: 500 mm, color: blue

 Max. current carrying capacity: 32 A

PLC-RSC-230UC/21AU - Relay Module

2966294

<https://www.phoenixcontact.com/in/products/2966294>

FBST 500-PLC GY - Continuous plug-in bridge

2966838

<https://www.phoenixcontact.com/in/products/2966838>



Continuous plug-in bridge, length: 500 mm, color: gray

 Max. current carrying capacity: 32 A

FBST 6-PLC RD - Single plug-in bridge

2966236

<https://www.phoenixcontact.com/in/products/2966236>

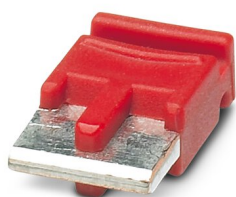

Single plug-in bridge, number of positions: 2, length: 6 mm, color: red

 Max. current carrying capacity: 6 A

PLC-RSC-230UC/21AU - Relay Module

2966294

<https://www.phoenixcontact.com/in/products/2966294>

FBST 6-PLC BU - Single plug-in bridge

2966812

<https://www.phoenixcontact.com/in/products/2966812>

Single plug-in bridge, number of positions: 2, length: 6 mm, color: blue

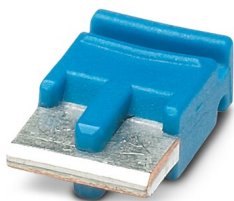

 Max. current carrying capacity: 6 A

FBST 6-PLC GY - Single plug-in bridge

2966825

<https://www.phoenixcontact.com/in/products/2966825>

Single plug-in bridge, number of positions: 2, length: 6 mm, color: gray

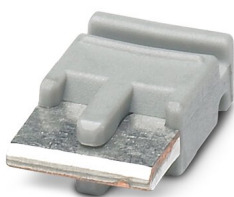

 Max. current carrying capacity: 6 A

PLC-RSC-230UC/21AU - Relay Module

2966294

<https://www.phoenixcontact.com/in/products/2966294>



FBST 8-PLC GY - Single plug-in bridge

2967688

<https://www.phoenixcontact.com/in/products/2967688>

Single plug-in bridge, number of positions: 2, length: 8 mm, color: gray



 Max. current carrying capacity: 6 A

PLC-ESK GY - Power terminal block

2966508

<https://www.phoenixcontact.com/in/products/2966508>

Power terminal block, for the input of up to four potentials, for mounting on NS 35/7.5



PLC-RSC-230UC/21AU - Relay Module



2966294

<https://www.phoenixcontact.com/in/products/2966294>

PLC-ATP BK - Separating plate

2966841

<https://www.phoenixcontact.com/in/products/2966841>



Separating plate, 2 mm thick, required at the start and end of a PLC terminal strip. Furthermore, it is used for: visual separation of groups, safe isolation of different voltages of neighboring PLC relays in acc. with DIN VDE 0106-101, isolation

SZF 1-0,6X3,5 - Screwdriver

1204517

<https://www.phoenixcontact.com/in/products/1204517>



Actuation tool, for ST terminal blocks, also suitable for use as a bladed screwdriver, size: 0.6 x 3.5 x 100 mm, 2-component grip, with non-slip grip

PLC-RSC-230UC/21AU - Relay Module



2966294

<https://www.phoenixcontact.com/in/products/2966294>

PLC-V8/FLK14/IN - System connection

2296553

<https://www.phoenixcontact.com/in/products/2296553>



V8 adapter for 8 x PLC-INTERFACE (6.2 mm), controller: PLC system cabling of input cards, connection 1: Screw connection 1x, connection 2: IDC/FLK pin strip 1x 14-position, connection 3: Plug-in connection (Can be snapped onto 8x PLC-INTERFACE terminals), number of channels: 8, control logic: plusschaltend

PLC-V8/FLK14/IN/M - System connection

2304115

<https://www.phoenixcontact.com/in/products/2304115>



V8 adapter for 8 x PLC-INTERFACE (6.2 mm), controller: PLC system cabling of input cards, connection 1: Screw connection 1x, connection 2: IDC/FLK pin strip 1x 14-position, connection 3: Plug-in connection (Can be snapped onto 8x PLC-INTERFACE terminals), number of channels: 8, control logic: minusschaltend

PLC-RSC-230UC/21AU - Relay Module



2966294

<https://www.phoenixcontact.com/in/products/2966294>

PLC-V8/D15S/IN - System connection

2296074

<https://www.phoenixcontact.com/in/products/2296074>



V8 adapter for 8 x PLC-INTERFACE (6.2 mm), controller: PLC system cabling of input cards, connection 1: Screw connection 1x, connection 2: D-SUB pin strip 1x 15-position, connection 3: Plug-in connection (Can be snapped onto 8x PLC-INTERFACE terminals), number of channels: 8, control logic: plusschaltend

PLC-V8/D15B/IN - System connection

2296087

<https://www.phoenixcontact.com/in/products/2296087>



V8 adapter for 8 x PLC-INTERFACE (6.2 mm), controller: PLC system cabling of input cards, connection 1: Screw connection 1x, connection 2: D-SUB socket strip 1x 15-position, connection 3: Plug-in connection (Can be snapped onto 8x PLC-INTERFACE terminals), number of channels: 8, control logic: plusschaltend

PLC-RSC-230UC/21AU - Relay Module

2966294

<https://www.phoenixcontact.com/in/products/2966294>

PLC-FA-5X20 - Fuse adapter

1186510

<https://www.phoenixcontact.com/in/products/1186510>



Safety plug adapter for use on a 6.2 mm PLC basic terminal block. For 5 x 20 mm fuses. Operating voltage: Universal. Without fuse failure indication.

PLC-FA-I-5X20-12-24UC - Fuse adapter

1186499

<https://www.phoenixcontact.com/in/products/1186499>



Safety plug adapter for use on a 6.2 mm PLC basic terminal block. For 5 x 20 mm fuses. Operating voltage: 12 ... 24 V AC/DC. With LED for fuse failure indication.

PLC-RSC-230UC/21AU - Relay Module

2966294

<https://www.phoenixcontact.com/in/products/2966294>



PLC-FA-I-5X20-120-230UC - Fuse adapter

1186508

<https://www.phoenixcontact.com/in/products/1186508>



Safety plug adapter for use on a 6.2 mm PLC basic terminal block. For 5 x 20 mm fuses. Operating voltage: 120 ... 230 V AC/DC. With LED for fuse failure indication.

ZB 6:UNBEDRUCKT - Zack marker strip

1051003

<https://www.phoenixcontact.com/in/products/1051003>



Zack marker strip, Strip, white, unlabeled, can be labeled with: PLOTMARK, CMS-P1-PLOTTER, mounting type: snapped, for terminal block width: 6.2 mm, lettering field size: 6.15 x 10.5 mm, Number of individual labels: 10

PLC-RSC-230UC/21AU - Relay Module



2966294

<https://www.phoenixcontact.com/in/products/2966294>

ZB 6 CUS - Zack marker strip

0824992

<https://www.phoenixcontact.com/in/products/0824992>



Zack marker strip, can be ordered: Strip, white, labeled according to customer specifications, mounting type: snap into tall marker groove, for terminal block width: 6.2 mm, lettering field size: 6.15 x 10.5 mm, Number of individual labels: 10

ZB 6,LGS:FORTL.ZAHLEN - Zack marker strip

1051016

<https://www.phoenixcontact.com/in/products/1051016>



Zack marker strip, Strip, white, labeled, can be labeled with: CMS-P1-PLOTTER, printed horizontally: consecutive numbers 1 ... 10, 11 ... 20, etc. up to 491 ... 500, mounting type: snapped, for terminal block width: 6.2 mm, lettering field size: 6.15 x 10.5 mm, Number of individual labels: 10

PLC-RSC-230UC/21AU - Relay Module



2966294

<https://www.phoenixcontact.com/in/products/2966294>

ZB 6,QR:FORTL.ZAHLEN - Zack marker strip

1051029

<https://www.phoenixcontact.com/in/products/1051029>

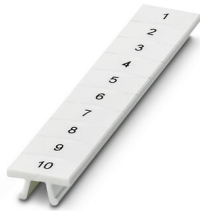

Zack marker strip, Strip, white, labeled, can be labeled with: CMS-P1-PLOTTER, Printed vertically: consecutive numbers 1 ... 10, 11 ... 20, etc. up to 491 ... 500, mounting type: snapped, for terminal block width: 6.2 mm, lettering field size: 6.15 x 10.5 mm, Number of individual labels: 10

ZB 6,LGS:GLEICHE ZAHLEN - Zack marker strip

1051032

<https://www.phoenixcontact.com/in/products/1051032>



Zack marker strip, Strip, white, labeled, can be labeled with: CMS-P1-PLOTTER, printed horizontally: Identical numbers 1 or 2, etc. up to 100, mounting type: snapped, for terminal block width: 6.2 mm, lettering field size: 6.15 x 10.5 mm, Number of individual labels: 10

PLC-RSC-230UC/21AU - Relay Module

2966294

<https://www.phoenixcontact.com/in/products/2966294>

ZB 6,LGS:L1-N,PE - Marker for terminal blocks

1051414

<https://www.phoenixcontact.com/in/products/1051414>



Marker for terminal blocks, Strip, white, labeled, can be labeled with: CMS-P1-PLOTTER, horizontal: L1, L2, L3, N, PE, L1, L2, L3, N, PE, mounting type: snapped, for terminal block width: 6.2 mm, lettering field size: 6.15 x 10.5 mm, Number of individual labels: 10

ZB 6,LGS:U-N - Marker for terminal blocks

1051430

<https://www.phoenixcontact.com/in/products/1051430>



Marker for terminal blocks, Strip, white, labeled, can be labeled with: CMS-P1-PLOTTER, printed horizontally: U, V, W, N, GND, U, V, W, N, GND, mounting type: snapped, for terminal block width: 6.2 mm, lettering field size: 6.15 x 10.5 mm, Number of individual labels: 10

PLC-RSC-230UC/21AU - Relay Module



2966294

<https://www.phoenixcontact.com/in/products/2966294>

UC-TM 6 - Marker for terminal blocks

0818085

<https://www.phoenixcontact.com/in/products/0818085>



Marker for terminal blocks, Sheet, white, unlabeled, can be labeled with: BLUEMARK ID COLOR, BLUEMARK ID, BLUEMARK CLED, PLOTMARK, CMS-P1-PLOTTER, mounting type: snapped, for terminal block width: 6.2 mm, lettering field size: 5.6 x 10.5 mm, Number of individual labels: 80

UC-TM 6 CUS - Marker for terminal blocks

0824589

<https://www.phoenixcontact.com/in/products/0824589>



Marker for terminal blocks, can be ordered: by sheet, white, labeled according to customer specifications, mounting type: snap into tall marker groove, for terminal block width: 6.2 mm, lettering field size: 5.6 x 10.5 mm, Number of individual labels: 80

PLC-RSC-230UC/21AU - Relay Module



2966294

<https://www.phoenixcontact.com/in/products/2966294>

UCT-TM 6 - Marker for terminal blocks

0828736

<https://www.phoenixcontact.com/in/products/0828736>



Marker for terminal blocks, Sheet, white, unlabeled, can be labeled with: TOPMARK NEO, TOPMARK LASER, BLUEMARK ID COLOR, BLUEMARK ID, BLUEMARK CLED, THERMOMARK PRIME, THERMOMARK CARD 2.0, THERMOMARK CARD, mounting type: snapped, for terminal block width: 6.2 mm, lettering field size: 5.6 x 10.5 mm, Number of individual labels: 60

UCT-TM 6 CUS - Marker for terminal blocks

0829602

<https://www.phoenixcontact.com/in/products/0829602>



Marker for terminal blocks, can be ordered: by sheet, white, labeled according to customer specifications, mounting type: snap into tall marker groove, for terminal block width: 6.2 mm, lettering field size: 5.6 x 10.5 mm, Number of individual labels: 60

PLC-RSC-230UC/21AU - Relay Module



2966294

<https://www.phoenixcontact.com/in/products/2966294>

NS 35/ 7,5 PERF 2000MM - DIN rail perforated

0801733

<https://www.phoenixcontact.com/in/products/0801733>



DIN rail perforated, acc. to EN 60715, material: Steel, galvanized, passivated with a thick layer, Standard profile, color: silver, Pack of 25 (50 m)

NS 35/ 7,5 UNPERF 2000MM - DIN rail, unperforated

0801681

<https://www.phoenixcontact.com/in/products/0801681>



DIN rail, unperforated, acc. to EN 60715, material: Steel, galvanized, passivated with a thick layer, Standard profile, color: silver, Pack of 25 (50 m)

PLC-RSC-230UC/21AU - Relay Module



2966294

<https://www.phoenixcontact.com/in/products/2966294>

NS 35/ 7,5 WH PERF 2000MM - DIN rail perforated

1204119

<https://www.phoenixcontact.com/in/products/1204119>



DIN rail perforated, acc. to EN 60715, material: Steel, Galvanized, white passivated, Standard profile, color: silver, Pack of 25 (50 m)

NS 35/ 7,5 WH UNPERF 2000MM-VPE 10 - DIN rail, unperforated

1204122

<https://www.phoenixcontact.com/in/products/1204122>



DIN rail, unperforated, acc. to EN 60715, material: Steel, Galvanized, white passivated, Standard profile, color: silver, Pack of 10 (20 m)

PLC-RSC-230UC/21AU - Relay Module

2966294

<https://www.phoenixcontact.com/in/products/2966294>

NS 35/ 7,5 AL UNPERF 2000MM - DIN rail, unperforated

0801704

<https://www.phoenixcontact.com/in/products/0801704>



DIN rail, unperforated, acc. to EN 60715, material: Aluminum, uncoated, Standard profile, color: silver, Pack of 25 (50 m)

NS 35/ 7,5 ZN PERF 2000MM - DIN rail perforated

1206421

<https://www.phoenixcontact.com/in/products/1206421>



DIN rail perforated, acc. to EN 60715, material: Steel, galvanized, Standard profile, color: silver, Pack of 25 (50 m)

PLC-RSC-230UC/21AU - Relay Module

2966294

<https://www.phoenixcontact.com/in/products/2966294>



NS 35/ 7,5 ZN UNPERF 2000MM - DIN rail, unperforated

1206434

<https://www.phoenixcontact.com/in/products/1206434>



DIN rail, unperforated, acc. to EN 60715, material: Steel, galvanized, Standard profile, color: silver, Pack of 25 (50 m)

NS 35/ 7,5 CU UNPERF 2000MM-VPE 10 - DIN rail, unperforated

0801762

<https://www.phoenixcontact.com/in/products/0801762>



DIN rail, unperforated, acc. to EN 60715, material: Copper, uncoated, Standard profile, color: copper-colored, Pack of 10 (20 m)

PLC-RSC-230UC/21AU - Relay Module



2966294

<https://www.phoenixcontact.com/in/products/2966294>

NS 35/ 7,5 CAP - End cap

1206560

<https://www.phoenixcontact.com/in/products/1206560>

DIN rail end piece, for DIN rail NS 35/7.5



NS 35/15 PERF 2000MM - DIN rail perforated

1201730

<https://www.phoenixcontact.com/in/products/1201730>



DIN rail perforated, similar to EN 60715, material: Steel, galvanized, passivated with a thick layer, Standard profile, color: silver, Pack of 25 (50 m)

PLC-RSC-230UC/21AU - Relay Module



2966294

<https://www.phoenixcontact.com/in/products/2966294>

NS 35/15 UNPERF 2000MM - DIN rail, unperforated

1201714

<https://www.phoenixcontact.com/in/products/1201714>



DIN rail, unperforated, similar to EN 60715, material: Steel, galvanized, passivated with a thick layer, Standard profile, color: silver, Pack of 25 (50 m)

NS 35/15 WH PERF 2000MM - DIN rail perforated

0806602

<https://www.phoenixcontact.com/in/products/0806602>



DIN rail perforated, similar to EN 60715, material: Steel, Galvanized, white passivated, Standard profile, color: white, Pack of 25 (50 m)

PLC-RSC-230UC/21AU - Relay Module



2966294

<https://www.phoenixcontact.com/in/products/2966294>

NS 35/15 WH UNPERF 2000MM-VPE 10 - DIN rail, unperforated

1204135

<https://www.phoenixcontact.com/in/products/1204135>



DIN rail, unperforated, similar to EN 60715, material: Steel, Galvanized, white passivated, Standard profile, color: silver, Pack of 10 (20 m)

NS 35/15 AL UNPERF 2000MM - DIN rail, unperforated

1201756

<https://www.phoenixcontact.com/in/products/1201756>



DIN rail, unperforated, similar to EN 60715, material: Aluminum, uncoated, Standard profile, color: silver

PLC-RSC-230UC/21AU - Relay Module

2966294

<https://www.phoenixcontact.com/in/products/2966294>

NS 35/15 ZN PERF 2000MM - DIN rail perforated

1206599

<https://www.phoenixcontact.com/in/products/1206599>



DIN rail perforated, similar to EN 60715, material: Steel, galvanized, Standard profile, color: silver, Pack of 25 (50 m)

NS 35/15 ZN UNPERF 2000MM - DIN rail, unperforated

1206586

<https://www.phoenixcontact.com/in/products/1206586>



DIN rail, unperforated, similar to EN 60715, material: Steel, galvanized, Standard profile, color: silver, Pack of 25 (50 m)

PLC-RSC-230UC/21AU - Relay Module



2966294

<https://www.phoenixcontact.com/in/products/2966294>

NS 35/15 CU UNPERF 2000MM-VPE 10 - DIN rail, unperforated

1201895

<https://www.phoenixcontact.com/in/products/1201895>



DIN rail, unperforated, similar to EN 60715, material: Copper, uncoated, Standard profile, color: copper-colored, Pack of 10 (20 m)

NS 35/15 CAP - End cap

1206573

<https://www.phoenixcontact.com/in/products/1206573>

DIN rail end piece, for DIN rail NS 35/15



PLC-RSC-230UC/21AU - Relay Module

2966294

<https://www.phoenixcontact.com/in/products/2966294>



NS 35/15-2,3 UNPERF 2000MM-VPE 10 - DIN rail, unperforated

1201798

<https://www.phoenixcontact.com/in/products/1201798>



DIN rail, unperforated, acc. to EN 60715, material: Steel, galvanized, passivated with a thick layer, Standard profile 2.3 mm, color: silver, Pack of 10 (20 m)

PLC-BSC-230UC/21 - Relay base

2966045

<https://www.phoenixcontact.com/in/products/2966045>



6.2 mm PLC basic terminal block with screw connection, without relay or solid-state relay, for mounting on DIN rail NS 35/7,5, 1 changeover contact, input voltage 230 V AC/DC

PLC-RSC-230UC/21AU - Relay Module



2966294

<https://www.phoenixcontact.com/in/products/2966294>

REL-MR- 60DC/21AU - Single relay

2961134

<https://www.phoenixcontact.com/in/products/2961134>

Plug-in miniature power relay, with multi-layer gold contact, 1 changeover contact, input voltage 60 V DC

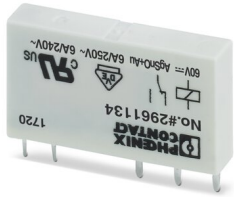

Phoenix Contact 2023 © - all rights reserved

<https://www.phoenixcontact.com>

PHOENIX CONTACT (I) Pvt. Ltd.

A-58/2, Okhla Industrial Area, Phase - II, New Delhi-110 020

+91.1275.71420

info@phoenixcontact.co.in