

REL-MR- 24DC/21HC - Single relay



2961312

<https://www.phoenixcontact.com/in/products/2961312>

Please be informed that the data shown in this PDF document is generated from our Online Catalog. Please find the complete data in the user documentation. Our General Terms of Use for Downloads are valid.



Plug-in miniature power relay, with power contact for high continuous currents, 1 changeover contact, input voltage 24 V DC

Your advantages

- Switching current of up to 16 A

Commercial Data

Item number	2961312
Packing unit	10 pc
Minimum order quantity	10 pc
Sales Key	CK6
Product Key	CK6195
Catalog Page	Page 290 (C-5-2019)
GTIN	4017918187576
Weight per Piece (including packing)	16.123 g
Weight per Piece (excluding packing)	12.91 g
Customs tariff number	85364900
Country of origin	AT

REL-MR- 24DC/21HC - Single relay



2961312

<https://www.phoenixcontact.com/in/products/2961312>

Technical Data

Product properties

Product type	Single relay
Set comprises	2967620 PLC-RSC- 24DC/21HC
	2967633 PLC-RSC- 24UC/21HC
	2967646 PLC-RSC- 48DC/21HC
	2912277 PLC-RSP- 24DC/21HC
	2912280 PLC-RSP- 24UC/21HC
	2912293 PLC-RSP- 48DC/21HC
	2900291 PLC-RPT- 24DC/21HC
	2900293 PLC-RPT- 24UC/21HC
	2900294 PLC-RPT- 48DC/21HC
	2834326 PR1-RSC3-LDP-24DC/21
	2834407 PR1-RSP3-LDP-24DC/21
	2903342 RIF-1-RPT-LDP-24DC/1X21
2903358 RIF-1-RSC-LDP-24DC/1X21	
Operating mode	100% operating factor
Mechanical service life	3x 10 ⁷ cycles

Insulation characteristics

Overvoltage category	III
Pollution degree	3

Electrical properties

Service life electrical	see diagram
Maximum power dissipation for nominal condition	0.41 W
Test voltage (Winding/contact)	5 kV AC (50 Hz, 1 min., winding/contact)

Input data

Coil side

Nominal input voltage U _N	24 V DC
Input voltage range	15.6 V DC ... 57.6 V DC
Typical input current at U _N	17 mA
Typical response time	7 ms
Typical release time	3 ms
Coil resistance	1440 Ω ±10 % (at 20 °C)

Output data

Switching

Contact type	1 changeover contact
Type of switch contact	Single contact
Drive and function	monostable

REL-MR- 24DC/21HC - Single relay

2961312

<https://www.phoenixcontact.com/in/products/2961312>

Drive (polarity)	bipolar
Contact material	AgNi
Maximum switching voltage	250 V AC/DC
Minimum switching voltage	12 V (at 10 mA)
Limiting continuous current	16 A
Maximum inrush current	50 A (20 ms)
Min. switching current	10 mA (at 12 V)
Interrupting rating (ohmic load) max.	384 W (at 24 V DC) 58 W (at 48 V DC) 48 W (at 60 V DC) 50 W (at 110 V DC) 80 W (at 220 V DC) 4000 VA (for 250 V AC)
Switching capacity	2 A (at 24 V, DC13) 0.2 A (at 110 V, DC13) 0.2 A (at 250 V, DC13) 6 A (at 24 V, AC15) 6 A (at 120 V, AC15) 6 A (at 250 V, AC15)
Motor load according to UL 508	1/2 HP, 120 V AC (N/O contact) 1 HP, 240 V AC (N/O contact) 1/3 HP, 120 V AC (N/C contact) 3/4 HP, 240 V AC (N/C contact) 1/4 HP, 200 ... 250 V AC

Connection data

Connection method	Plug / solder connection
-------------------	--------------------------

Dimensions

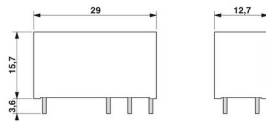
Dimensional drawing	
Width	12.7 mm
Height	29 mm
Depth	15.7 mm

Environmental and real-life conditions

Ambient conditions

Degree of protection	RT II
Ambient temperature (operation)	-40 °C ... 85 °C
Ambient temperature (storage/transport)	-40 °C ... 85 °C

REL-MR- 24DC/21HC - Single relay



2961312

<https://www.phoenixcontact.com/in/products/2961312>

Approvals

Corrosive gas test

Identification	ISA-S71.04. G3 Harsh Group
	EN 60068-2-60

Standards and regulations

Standards/regulations	IEC 60664
	EN 50178
	EN 61810-1

Mounting

Assembly instructions	Can be aligned without spacing ($> 70\text{ °C} \geq 2.5\text{ mm}$)
Mounting position	any

Drawings

Dimensional drawing

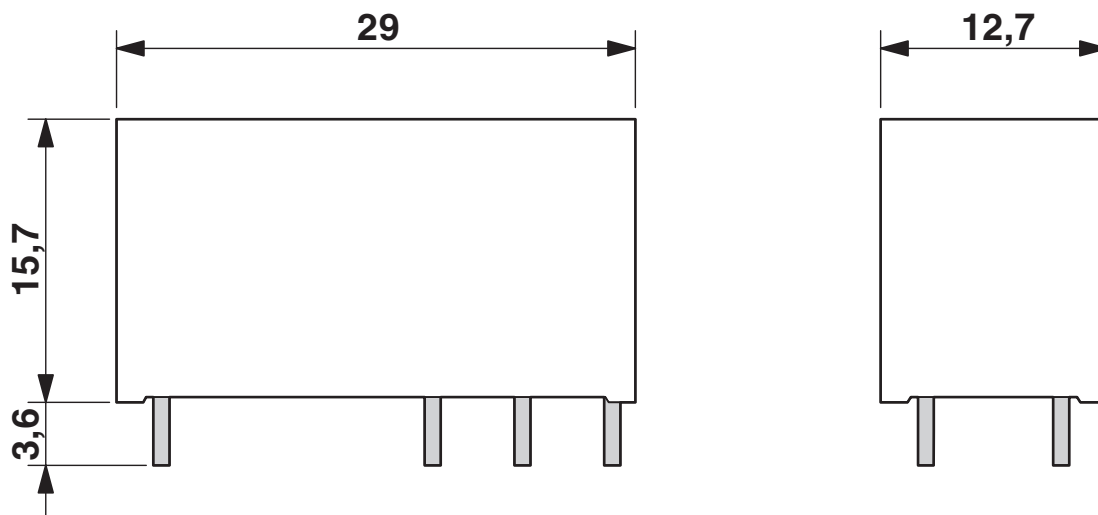

Diagram

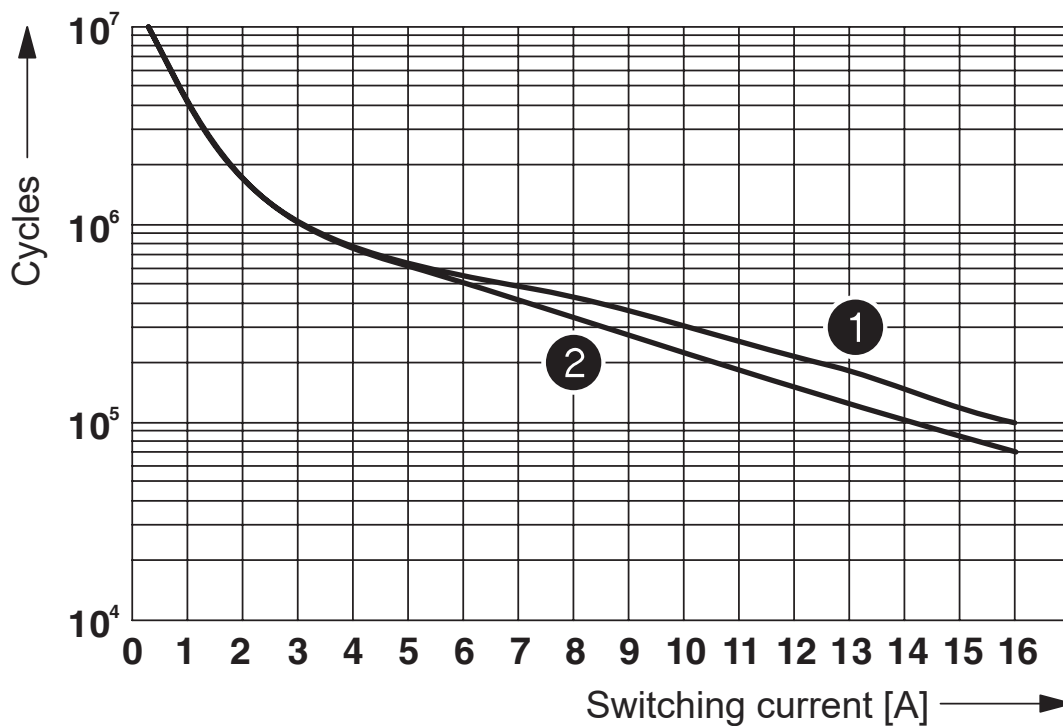

- ① 250 V AC, ohmic load (DC coils)
- ② 250 V AC, ohmic load (AC coils)

Electrical service life

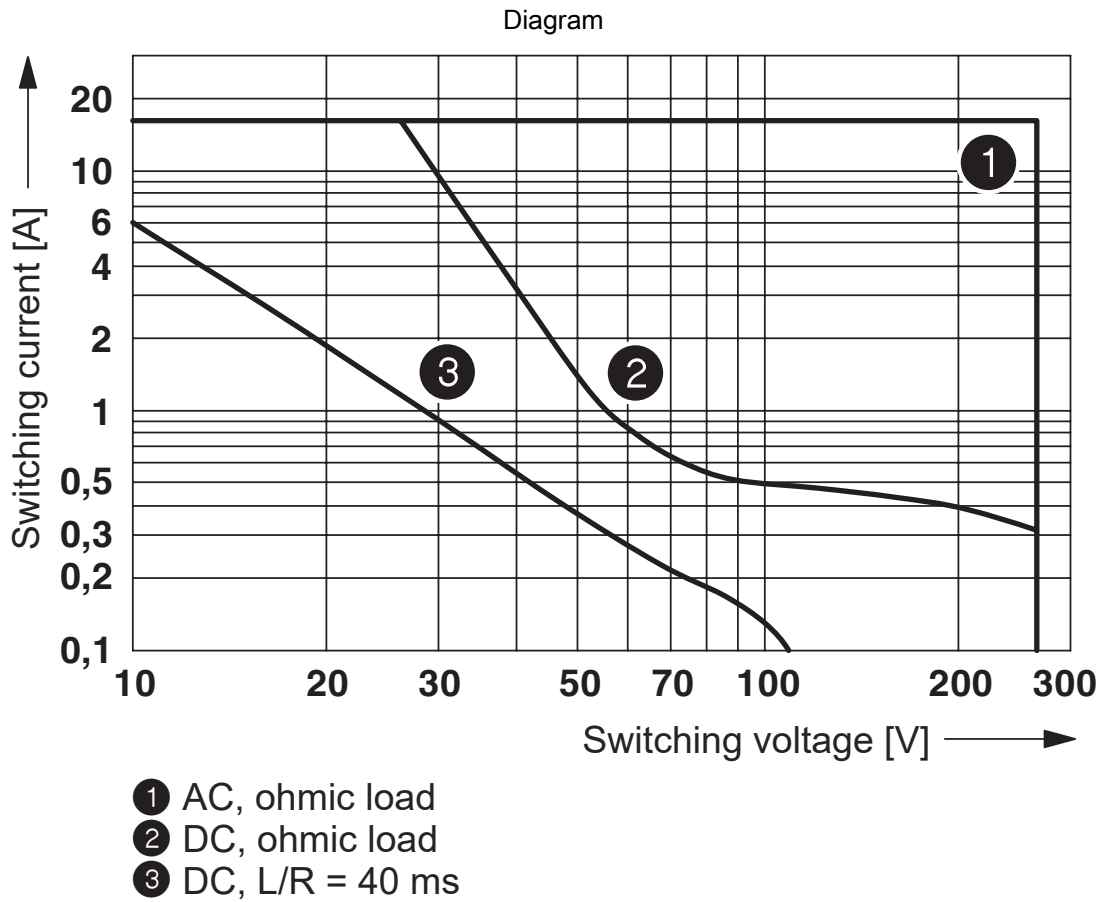

Interrupting rating

Diagram

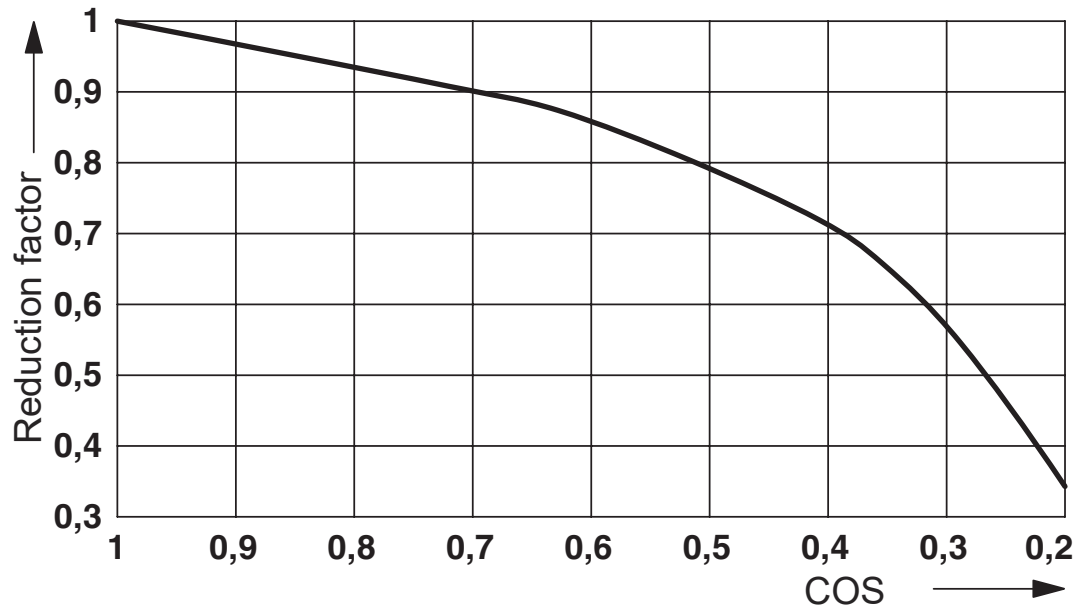

Service life reduction factor with various cos phi

Diagram

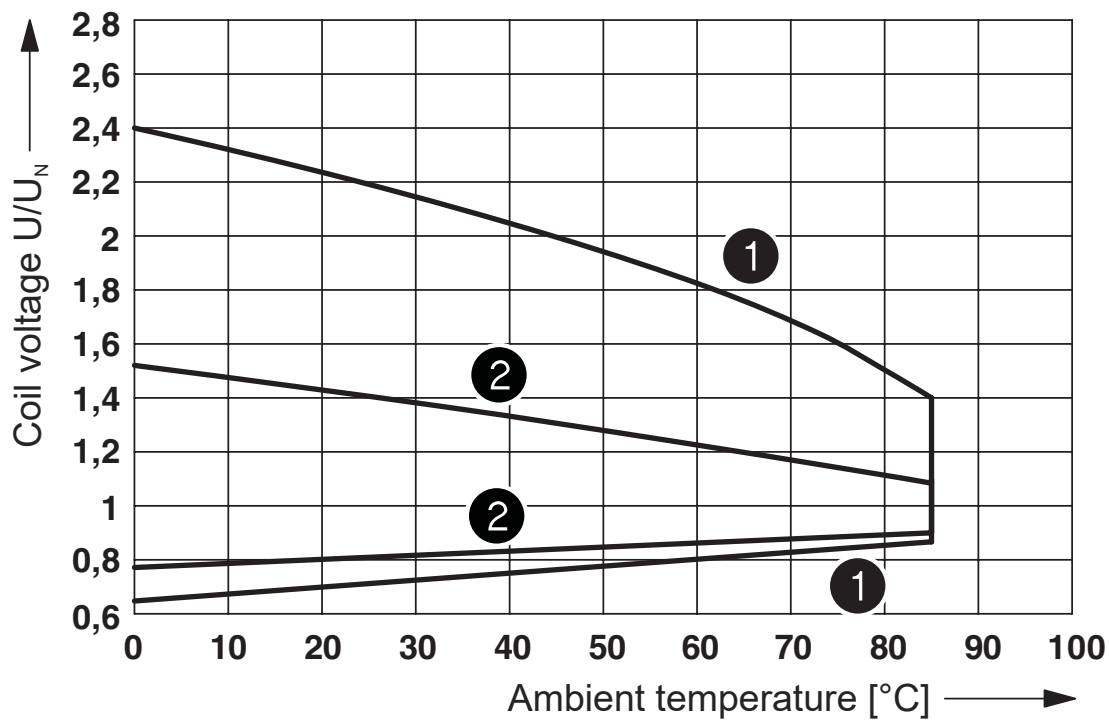

- ① DC coils
- ② AC coils

Operating voltage range

Circuit diagram

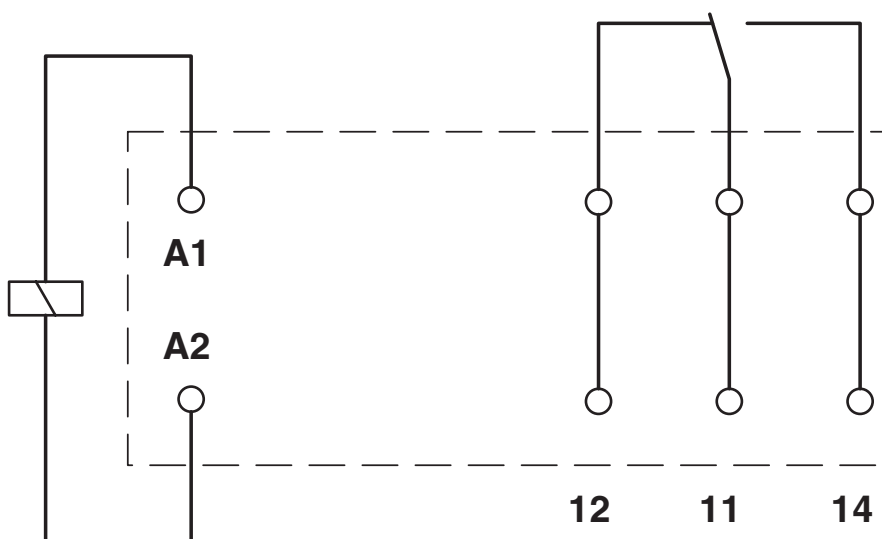

REL-MR- 24DC/21HC - Single relay



2961312

<https://www.phoenixcontact.com/in/products/2961312>

Drilling plan/solder pad geometry

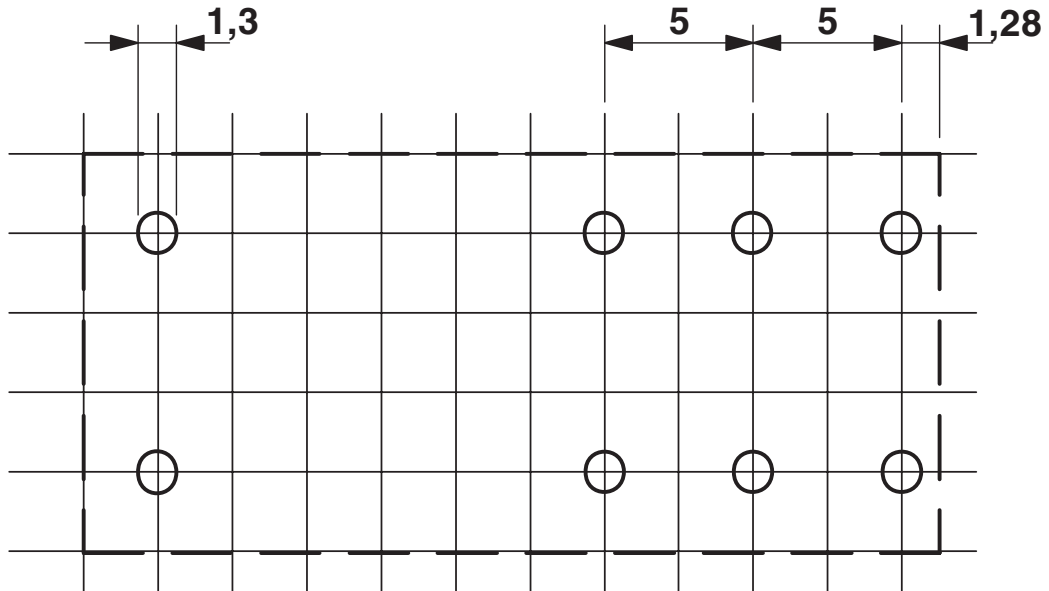

Basic pitch 2.5 mm

REL-MR- 24DC/21HC - Single relay



2961312

<https://www.phoenixcontact.com/in/products/2961312>

Approvals



cUL Recognized
Approval ID: FILE E 228652



UL Recognized
Approval ID: FILE E 228652



EAC
Approval ID: TR_TS_D_00573_c



UL Recognized
Approval ID: FILE E 228652



EAC
Approval ID: RU*C-DE.*08.B.00010



VDE Zeichengenehmigung
Approval ID: 40007758



VDE Zeichengenehmigung
Approval ID: 40048281



PRS
Approval ID: TE/2109/880590/16



cUL Recognized
Approval ID: FILE E 228652



cUL Recognized
Approval ID: FILE E 172140



UL Recognized
Approval ID: FILE E 172140

REL-MR- 24DC/21HC - Single relay



2961312

<https://www.phoenixcontact.com/in/products/2961312>

Classifications

ECLASS

ECLASS-11.0	27371601
ECLASS-12.0	27371601
ECLASS-13.0	27371601

ETIM

ETIM 8.0	EC001437
----------	----------

UNSPSC

UNSPSC 21.0	39122300
-------------	----------

REL-MR- 24DC/21HC - Single relay



2961312

<https://www.phoenixcontact.com/in/products/2961312>

Environmental Product Compliance

China RoHS	Environmentally friendly use period: unlimited = EFUP-e
	No hazardous substances above threshold values

REL-MR- 24DC/21HC - Single relay

2961312

<https://www.phoenixcontact.com/in/products/2961312>

Accessories

PLC-BSC- 24DC/21HC - Relay base

2967772

<https://www.phoenixcontact.com/in/products/2967772>



14 mm PLC basic terminal block for high continuous currents with screw connection, without relay or solid-state relay, for mounting on DIN rail NS 35/7,5, 1 changeover contact, input voltage 24 V DC

PLC-BSC- 24UC/21HC - Relay base

2967785

<https://www.phoenixcontact.com/in/products/2967785>



14 mm PLC basic terminal block for high continuous currents with screw connection, without relay or solid-state relay, for mounting on DIN rail NS 35/7,5, 1 changeover contact, input voltage 24 V AC/DC

REL-MR- 24DC/21HC - Single relay

2961312

<https://www.phoenixcontact.com/in/products/2961312>



PLC-BSC- 48DC/21HC - Relay base

2967798

<https://www.phoenixcontact.com/in/products/2967798>



14 mm PLC basic terminal block for high continuous currents with screw connection, without relay or solid-state relay, for mounting on DIN rail NS 35/7,5, 1 changeover contact, input voltage 48 V DC

PLC-BPT- 24DC/21HC - Relay base

2900254

<https://www.phoenixcontact.com/in/products/2900254>



14 mm PLC basic terminal block for high continuous currents with Push-in connection, without relay or solid-state relay, for mounting on DIN rail NS 35/7,5, 1 changeover contact, input voltage 24 V DC

REL-MR- 24DC/21HC - Single relay

2961312

<https://www.phoenixcontact.com/in/products/2961312>



PLC-BPT- 24UC/21HC - Relay base

2900255

<https://www.phoenixcontact.com/in/products/2900255>



14 mm PLC basic terminal block for high continuous currents with Push-in connection, without relay or solid-state relay, for mounting on DIN rail NS 35/7,5, 1 changeover contact, input voltage 24 V AC/DC

PLC-BPIT- 48DC/21HC - Relay base

2900256

<https://www.phoenixcontact.com/in/products/2900256>



14 mm PLC basic terminal block for high continuous currents with Push-in connection, without relay or solid-state relay, for mounting on DIN rail NS 35/7,5, 1 changeover contact, input voltage 48 V DC

REL-MR- 24DC/21HC - Single relay



2961312

<https://www.phoenixcontact.com/in/products/2961312>

RIF-1-BPT/2X21 - Relay base

2900931

<https://www.phoenixcontact.com/in/products/2900931>

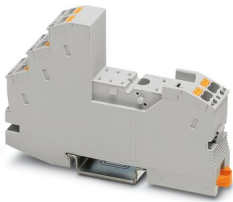

Relay base RIF-1..., for miniature power relay with 1 or 2 changeover contacts or solid-state relays of the same design, Push-in connection, plug-in option for input/interference suppression modules, for mounting on NS 35/7,5

RIF-1-BSC/2X21 - Relay base

2900930

<https://www.phoenixcontact.com/in/products/2900930>



RIF-1... relay base, for miniature power relay with 1 or 2 changeover contacts or identical solid-state relays, screw connection, plug-in option for input/interference suppression modules, for mounting on NS 35/7,5

Phoenix Contact 2023 © - all rights reserved
<https://www.phoenixcontact.com>

PHOENIX CONTACT (I) Pvt. Ltd.
A-58/2, Okhla Industrial Area, Phase - II, New Delhi-110 020

+91.1275.71420
info@phoenixcontact.co.in