

# REL-MR- 12DC/21HC - Single relay



2961309

<https://www.phoenixcontact.com/in/products/2961309>

Please be informed that the data shown in this PDF document is generated from our Online Catalog. Please find the complete data in the user documentation. Our General Terms of Use for Downloads are valid.



Plug-in miniature power relay, with power contact for high continuous currents, 1 changeover contact, input voltage 12 V DC

## Your advantages

- Switching current of up to 16 A

## Commercial Data

Item number	2961309
Packing unit	10 pc
Minimum order quantity	10 pc
Sales Key	CK6
Product Key	CK6195
Catalog Page	Page 290 (C-5-2019)
GTIN	4017918187552
Weight per Piece (including packing)	16.816 g
Weight per Piece (excluding packing)	15.7 g
Customs tariff number	85364900
Country of origin	AT

# REL-MR- 12DC/21HC - Single relay



2961309

<https://www.phoenixcontact.com/in/products/2961309>

## Technical Data

### Product properties

Product type	Single relay
Set comprises	2967617 PLC-RSC- 12DC/21HC
	2912264 PLC-RSP- 12DC/21HC
	2900290 PLC-RPT- 12DC/21HC
	2987079 PLC-RSP- 24UC/21HC/RW
	2900324 PLC-RPT- 24UC/21HC/RW
	2906224 RIF-1-RPT-LDP-12DC/1X21
	2908500 RIF-1-RSC-LDP-12DC/1X21
Operating mode	100% operating factor
Mechanical service life	3x 10 <sup>7</sup> cycles

### Insulation characteristics

Overvoltage category	III
Pollution degree	3

### Electrical properties

Service life electrical	see diagram
Maximum power dissipation for nominal condition	0.4 W
Test voltage (Winding/contact)	5 kV AC (50 Hz, 1 min., winding/contact)

### Input data

#### Coil side

Nominal input voltage $U_N$	12 V DC
Input voltage range	7.8 V DC ... 28.8 V DC
Input voltage range in reference to $U_N$	see diagram
Typical input current at $U_N$	33 mA
Typical response time	7 ms
Typical release time	3 ms
Coil resistance	360 $\Omega$ $\pm$ 10 % (at 20 °C)

### Output data

#### Switching

Contact type	1 changeover contact
Type of switch contact	Single contact
Drive and function	monostable
Drive (polarity)	bipolar
Contact material	AgNi
Maximum switching voltage	250 V AC/DC
Minimum switching voltage	12 V (at 10 mA)
Limiting continuous current	16 A

# REL-MR- 12DC/21HC - Single relay



2961309

<https://www.phoenixcontact.com/in/products/2961309>

Maximum inrush current	50 A (20 ms)
Min. switching current	10 mA (at 12 V)
Interrupting rating (ohmic load) max.	384 W (at 24 V DC)
	58 W (at 48 V DC)
	48 W (at 60 V DC)
	50 W (at 110 V DC)
	80 W (at 220 V DC)
	4000 VA (for 250 V AC)
Switching capacity	2 A (at 24 V, DC13)
	0.2 A (at 110 V, DC13)
	0.2 A (at 250 V, DC13)
	6 A (at 24 V, AC15)
	6 A (at 120 V, AC15)
	6 A (at 250 V, AC15)
Motor load according to UL 508	1/2 HP, 120 V AC (N/O contact)
	1 HP, 240 V AC (N/O contact)
	1/3 HP, 120 V AC (N/C contact)
	3/4 HP, 240 V AC (N/C contact)
	1/4 HP, 200 ... 250 V AC

## Connection data

Connection method	Plug / solder connection
-------------------	--------------------------

## Dimensions

Dimensional drawing	
Width	12.7 mm
Height	29 mm
Depth	15.7 mm

## Environmental and real-life conditions

### Ambient conditions

Degree of protection	RT II
Ambient temperature (operation)	-40 °C ... 85 °C
Ambient temperature (storage/transport)	-40 °C ... 85 °C

## Approvals

### Corrosive gas test

Identification	ISA-S71.04. G3 Harsh Group
	EN 60068-2-60

# REL-MR- 12DC/21HC - Single relay



2961309

<https://www.phoenixcontact.com/in/products/2961309>

## Standards and regulations

Standards/regulations	IEC 60664
	EN 50178
	EN 61810-1

## Mounting

Assembly instructions	Can be aligned without spacing ( $> 70\text{ °C} \geq 2.5\text{ mm}$ )
Mounting position	any

## Drawings

Circuit diagram

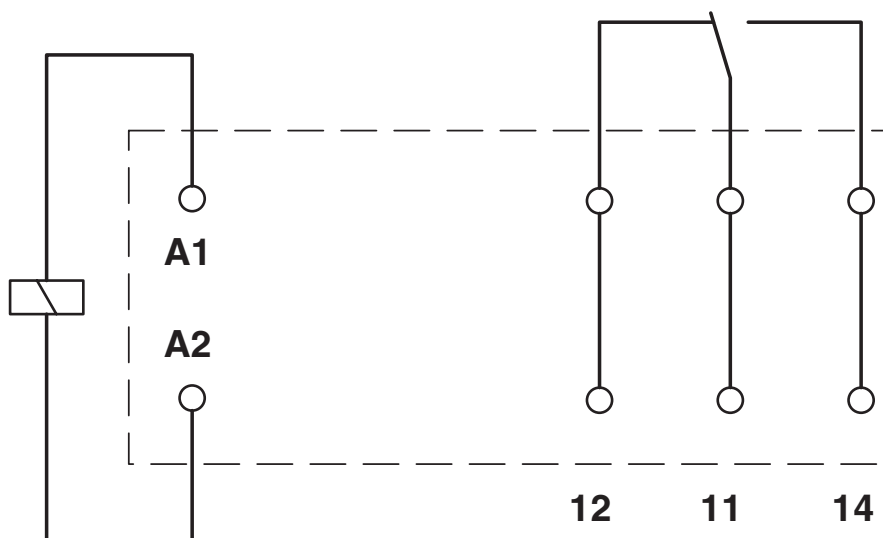

Diagram

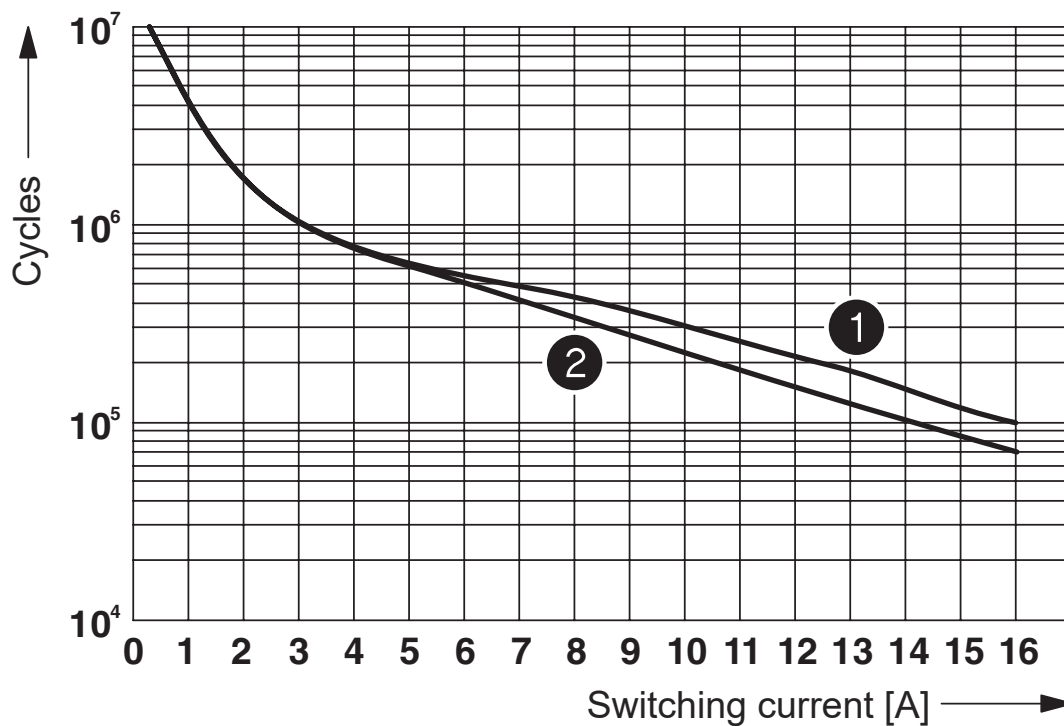

- ① 250 V AC, ohmic load (DC coils)
- ② 250 V AC, ohmic load (AC coils)

Electrical service life

# REL-MR- 12DC/21HC - Single relay

2961309

<https://www.phoenixcontact.com/in/products/2961309>

Drilling plan/solder pad geometry

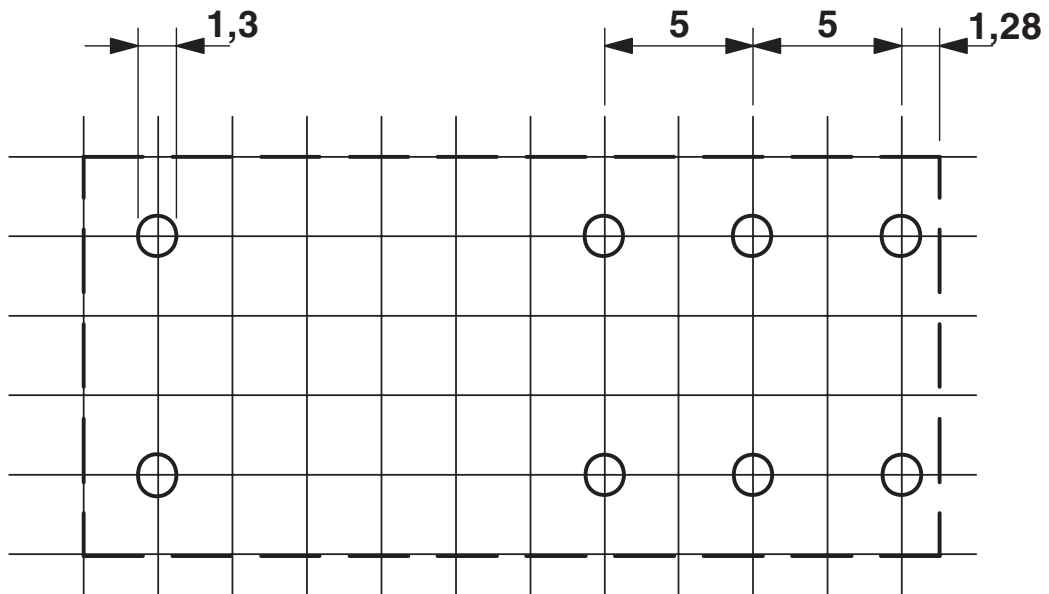

a = pitch division 2.5 mm

Dimensional drawing

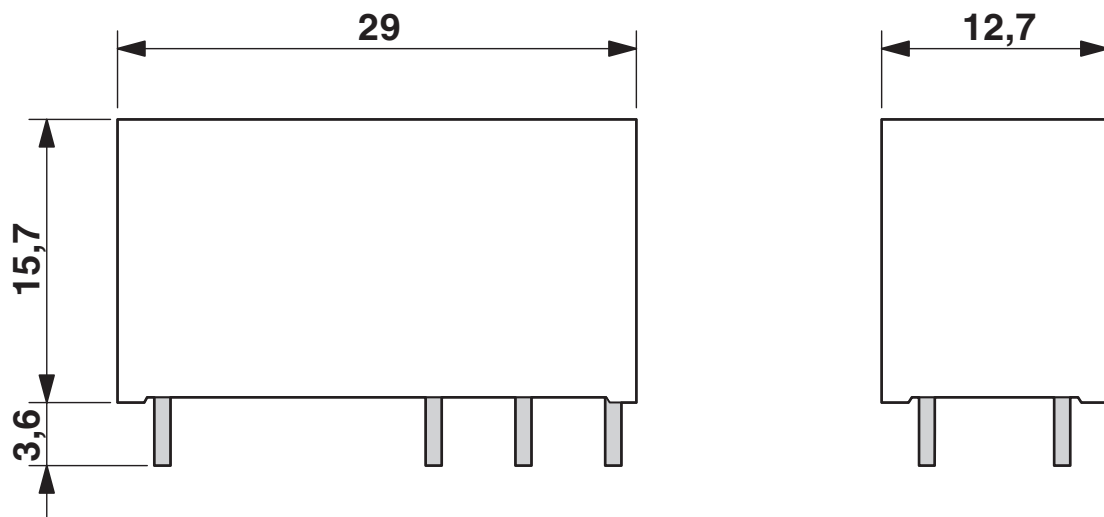

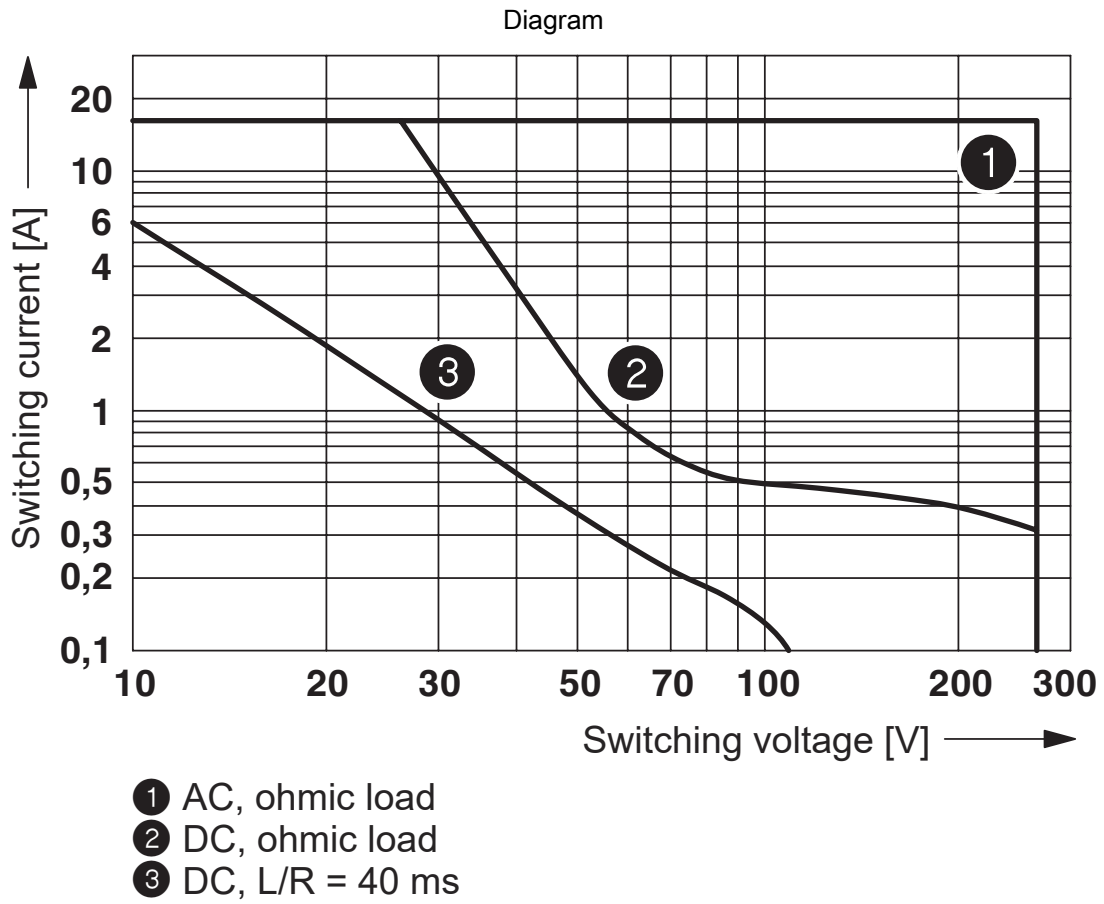

Interrupting rating

# REL-MR- 12DC/21HC - Single relay

2961309

<https://www.phoenixcontact.com/in/products/2961309>

Diagram

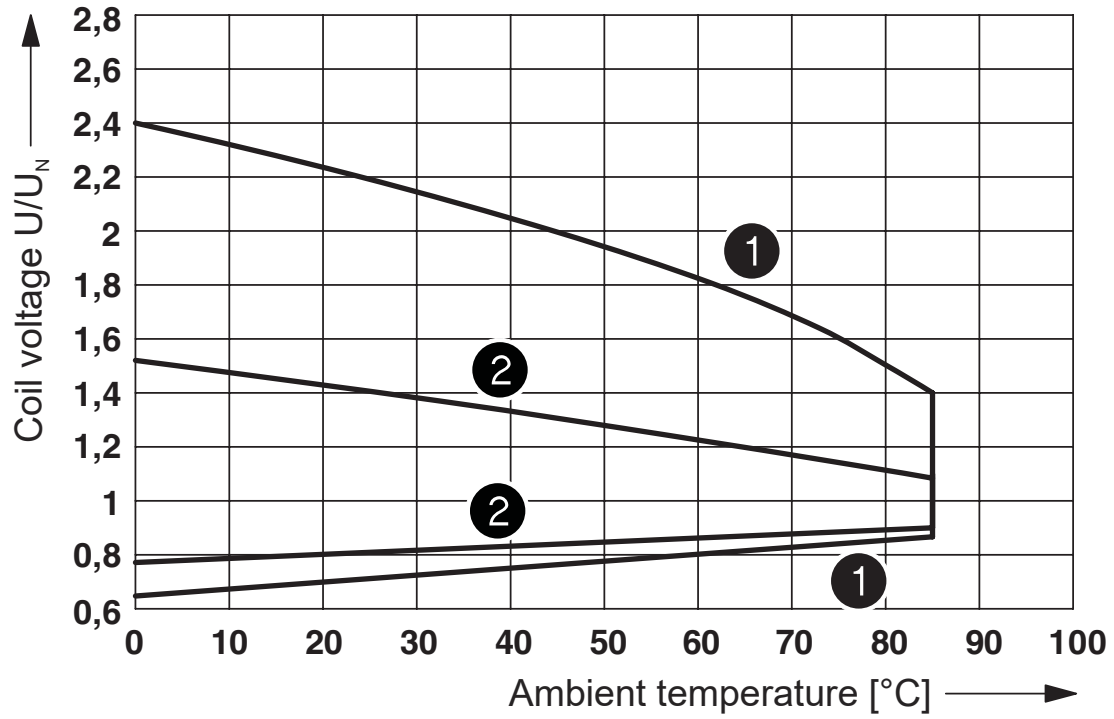

- ① DC coils
- ② AC coils

Operating voltage range



Diagram

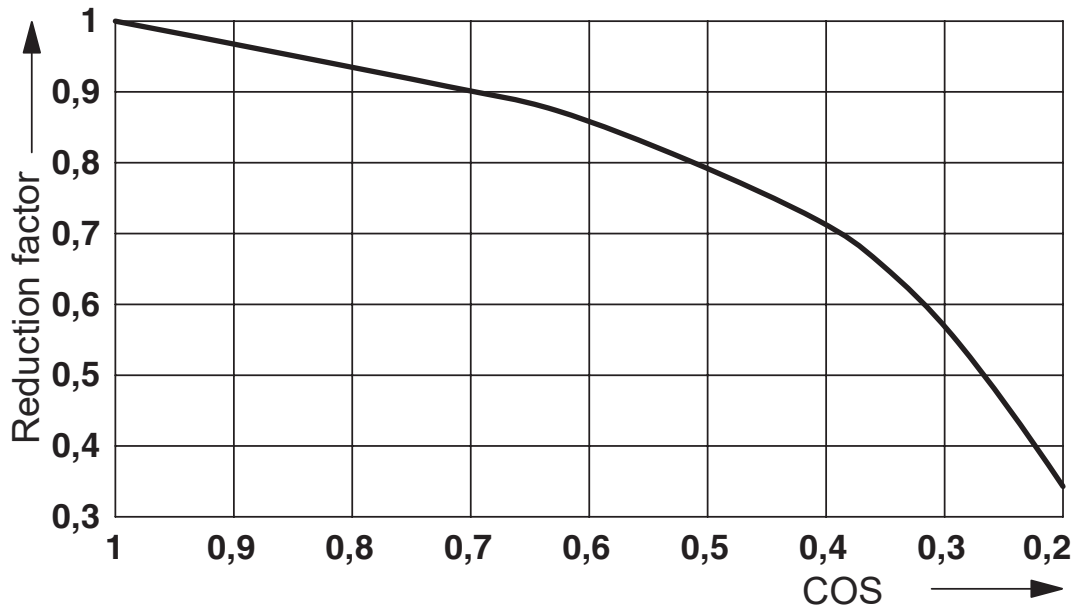

Service life reduction factor with various cos phi

# REL-MR- 12DC/21HC - Single relay



2961309

<https://www.phoenixcontact.com/in/products/2961309>

## Approvals



**cUL Recognized**  
Approval ID: FILE E 228652



**UL Recognized**  
Approval ID: FILE E 228652



**EAC**  
Approval ID: TR\_TS\_D\_00573\_c



**UL Recognized**  
Approval ID: FILE E 228652



**EAC**  
Approval ID: RU\*C-DE.\*08.B.00010



**VDE Zeichengenehmigung**  
Approval ID: 40007758



**VDE Zeichengenehmigung**  
Approval ID: 40048281



**PRS**  
Approval ID: TE/2109/880590/16



**cUL Recognized**  
Approval ID: FILE E 228652



**cUL Recognized**  
Approval ID: FILE E 172140



**UL Recognized**  
Approval ID: FILE E 172140

# REL-MR- 12DC/21HC - Single relay



2961309

<https://www.phoenixcontact.com/in/products/2961309>

## Classifications

### ECLASS

ECLASS-11.0	27371601
ECLASS-12.0	27371601
ECLASS-13.0	27371601

### ETIM

ETIM 8.0	EC001437
----------	----------

### UNSPSC

UNSPSC 21.0	39122300
-------------	----------

# REL-MR- 12DC/21HC - Single relay



2961309

<https://www.phoenixcontact.com/in/products/2961309>

## Environmental Product Compliance

China RoHS	Environmentally friendly use period: unlimited = EFUP-e
	No hazardous substances above threshold values

# REL-MR- 12DC/21HC - Single relay

2961309

<https://www.phoenixcontact.com/in/products/2961309>

## Accessories

### PLC-BPT- 12DC/21HC - Relay base

2900253

<https://www.phoenixcontact.com/in/products/2900253>



14 mm PLC basic terminal block for high continuous currents with Push-in connection, without relay or solid-state relay, for mounting on DIN rail NS 35/7,5, 1 changeover contact, input voltage 12 V DC

---

### PLC-BSC- 12DC/21HC - Relay base

2967769

<https://www.phoenixcontact.com/in/products/2967769>



14 mm PLC basic terminal block for high continuous currents with screw connection, without relay or solid-state relay, for mounting on DIN rail NS 35/7,5, 1 changeover contact, input voltage 12 V DC

# REL-MR- 12DC/21HC - Single relay



2961309

<https://www.phoenixcontact.com/in/products/2961309>

## RIF-1-BPT/2X21 - Relay base

2900931

<https://www.phoenixcontact.com/in/products/2900931>



Relay base RIF-1..., for miniature power relay with 1 or 2 changeover contacts or solid-state relays of the same design, Push-in connection, plug-in option for input/interference suppression modules, for mounting on NS 35/7,5

---

## RIF-1-BSC/2X21 - Relay base

2900930

<https://www.phoenixcontact.com/in/products/2900930>



RIF-1... relay base, for miniature power relay with 1 or 2 changeover contacts or identical solid-state relays, screw connection, plug-in option for input/interference suppression modules, for mounting on NS 35/7,5

---

Phoenix Contact 2023 © - all rights reserved  
<https://www.phoenixcontact.com>

PHOENIX CONTACT (I) Pvt. Ltd.  
A-58/2, Okhla Industrial Area, Phase - II, New Delhi-110 020

+91.1275.71420  
[info@phoenixcontact.co.in](mailto:info@phoenixcontact.co.in)