

# REL-MR- 12DC/21-21AU - Single relay



2961299

<https://www.phoenixcontact.com/in/products/2961299>

Please be informed that the data shown in this PDF document is generated from our Online Catalog. Please find the complete data in the user documentation. Our General Terms of Use for Downloads are valid.



Plug-in miniature power relay, with multi-layer gold contact, 2 changeover contacts, input voltage 12 V DC

## Your advantages

- RT III-proof (wash-proof)

## Commercial Data

Item number	2961299
Packing unit	10 pc
Minimum order quantity	10 pc
Sales Key	CK6
Product Key	CK6195
Catalog Page	Page 290 (C-5-2019)
GTIN	4017918164041
Weight per Piece (including packing)	16.34 g
Weight per Piece (excluding packing)	14.98 g
Customs tariff number	85364900
Country of origin	AT

## Technical Data

### Product properties

Product type	Single relay
Set comprises	2967277 PLC-RSC- 12DC/21-21AU
	2912565 PLC-RSP- 12DC/21-21AU
	2900337 PLC-RPT- 12DC/21-21AU
	2987118 PLC-RSP- 24UC/21-21AU/RW
	2900349 PLC-RPT- 24UC/21-21AU/RW
Operating mode	100% operating factor
Mechanical service life	3x 10 <sup>7</sup> cycles

### Insulation characteristics

Insulation	Basic insulation
------------	------------------

### Insulation characteristics

Insulation	Basic insulation
Overvoltage category	III
Pollution degree	3

### Electrical properties

Service life electrical	see diagram
Maximum power dissipation for nominal condition	0.4 W
Test voltage (Winding/contact)	5 kV AC (50 Hz, 1 min., winding/contact)
Test voltage (Contact/contact)	2.5 kV AC (50 Hz, 1 min., contact/contact)

### Input data

#### Coil side

Nominal input voltage $U_N$	12 V DC
Input voltage range	7.8 V DC ... 29.76 V DC
Typical input current at $U_N$	33 mA
Typical response time	7 ms
Typical release time	3 ms
Coil resistance	360 $\Omega$ $\pm$ 10 % (at 20 °C)

### Output data

#### Switching

Contact type	2 changeover contacts
Type of switch contact	Single contact
Drive and function	monostable
Drive (polarity)	bipolar
Contact material	AgNi, hard gold-plated
Maximum switching voltage	30 V AC

# REL-MR- 12DC/21-21AU - Single relay



2961299

<https://www.phoenixcontact.com/in/products/2961299>

	36 V DC
Minimum switching voltage	100 mV (at 10 mA)
Limiting continuous current	50 mA
Maximum inrush current	50 mA
Min. switching current	1 mA (at 24 V)
Interrupting rating (ohmic load) max.	1.2 W (at 24 V DC)
Switching capacity min.	0.12 W

Switching: when the gold layer is destroyed

Note	the following values are applicable if a gold layer is destroyed
Contact material	AgNi
Maximum switching voltage	250 V
Minimum switching voltage	5 V (at 10 mA)
Limiting continuous current	8 A
Maximum inrush current	15 A (300 ms)
Min. switching current	10 mA (At 5 V)
Interrupting rating (ohmic load) max.	190 W (at 24 V DC) 85 W (at 48 V DC) 60 W (at 60 V DC) 44 W (at 110 V DC) 60 W (at 220 V DC) 2000 VA (for 250 V AC)
Switching capacity	2 A (at 24 V, DC13) 0.2 A (at 110 V, DC13) 0.2 A (at 250 V, DC13) 2 A (at 24 V, AC15) 2 A (at 120 V, AC15) 2 A (at 250 V, AC15)

## Connection data

Connection method	Plug / solder connection
-------------------	--------------------------

## Dimensions

Dimensional drawing	
Width	12.7 mm
Height	29 mm
Depth	15.7 mm

## Environmental and real-life conditions

# REL-MR- 12DC/21-21AU - Single relay



2961299

<https://www.phoenixcontact.com/in/products/2961299>

## Ambient conditions

Degree of protection	RT III
Ambient temperature (operation)	-40 °C ... 85 °C
Ambient temperature (storage/transport)	-40 °C ... 85 °C

## Approvals

### Corrosive gas test

Identification	ISA-S71.04. G3 Harsh Group
	EN 60068-2-60

## Standards and regulations

Standards/regulations	IEC 60664
	EN 50178
	EN 61810-1

## Mounting

Assembly instructions	Can be aligned without spacing ( $> 70 \text{ °C} \geq 2.5 \text{ mm}$ )
Mounting position	any

# REL-MR- 12DC/21-21AU - Single relay



2961299

<https://www.phoenixcontact.com/in/products/2961299>

## Drawings

Drilling plan/solder pad geometry

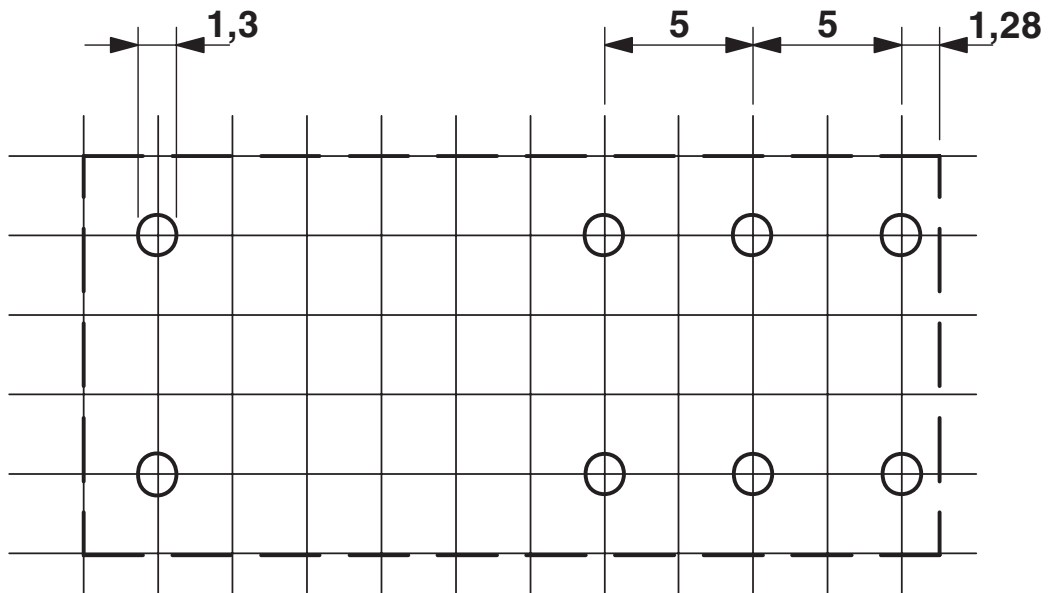

a = pitch division 2.5 mm

Dimensional drawing

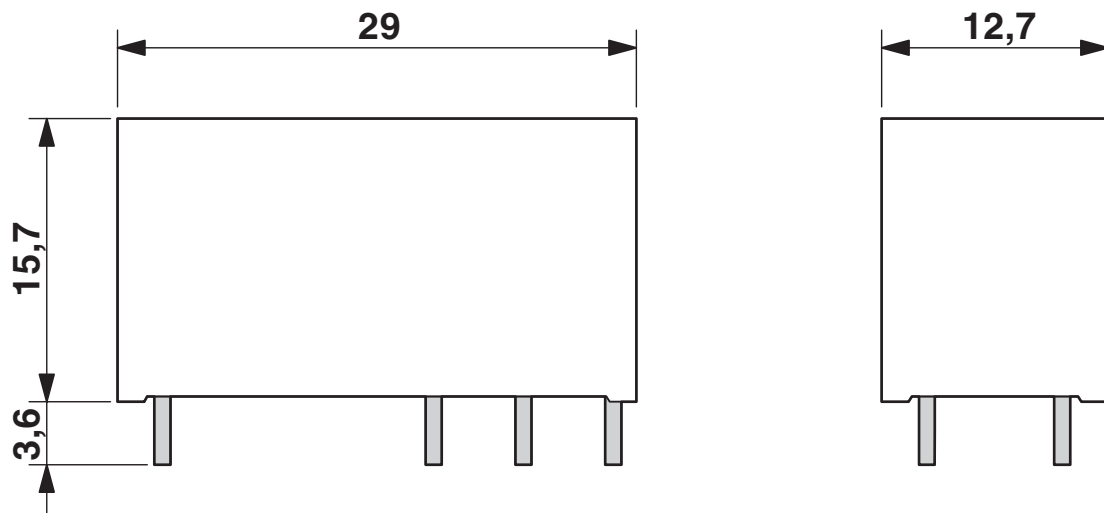

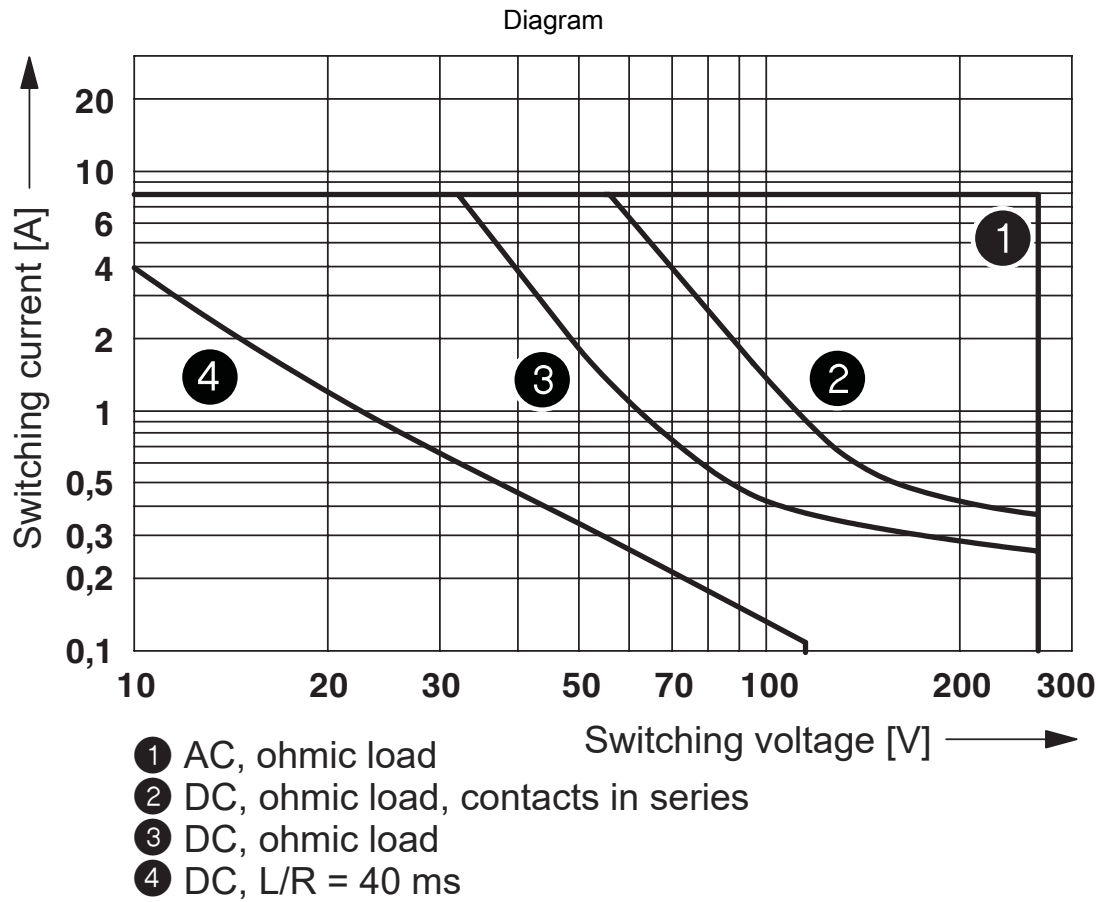

Interrupting rating

Diagram

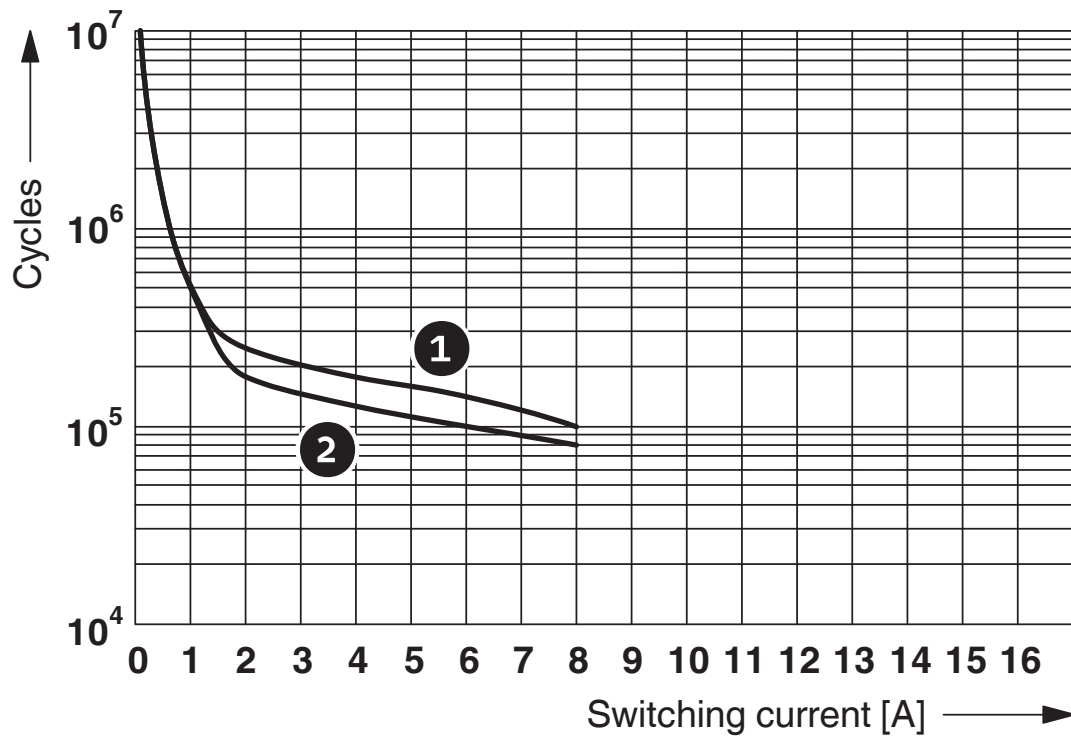

- ① 250 V AC, ohmic load (DC coils)
- ② 250 V AC, ohmic load (AC coils)

Electrical service life

Diagram

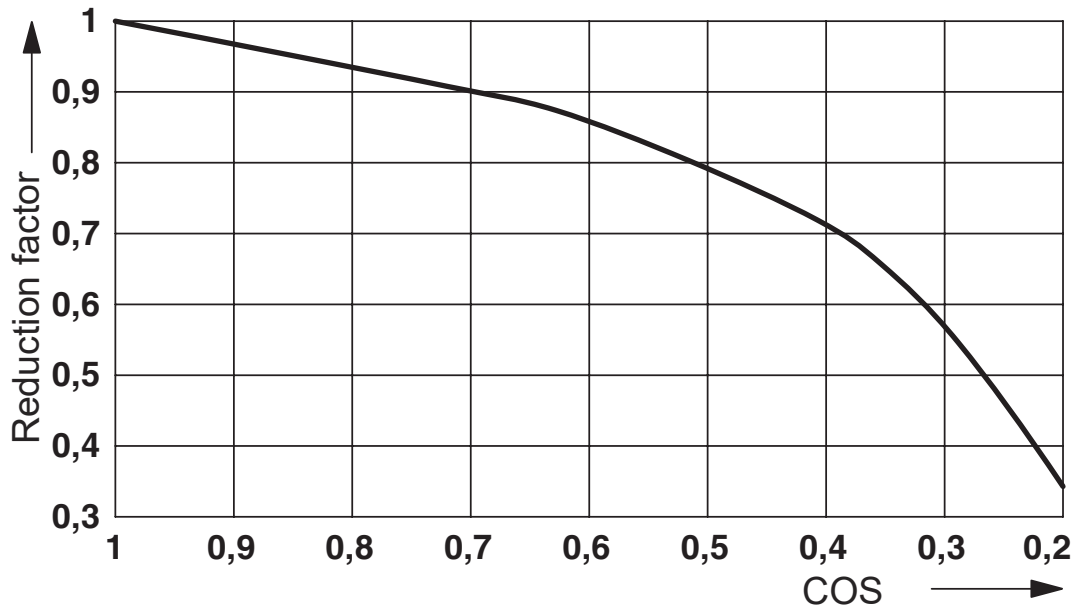

Service life reduction factor with various cos phi

Circuit diagram

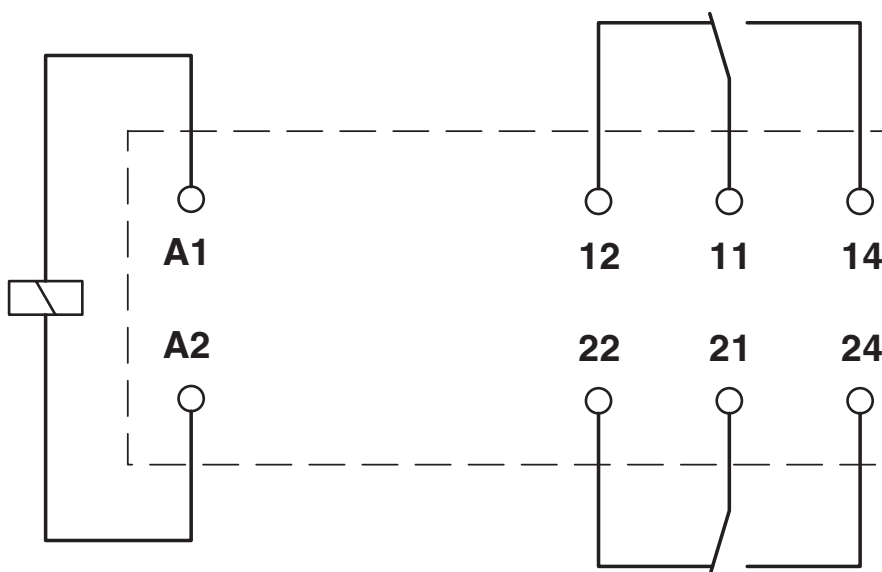



Diagram

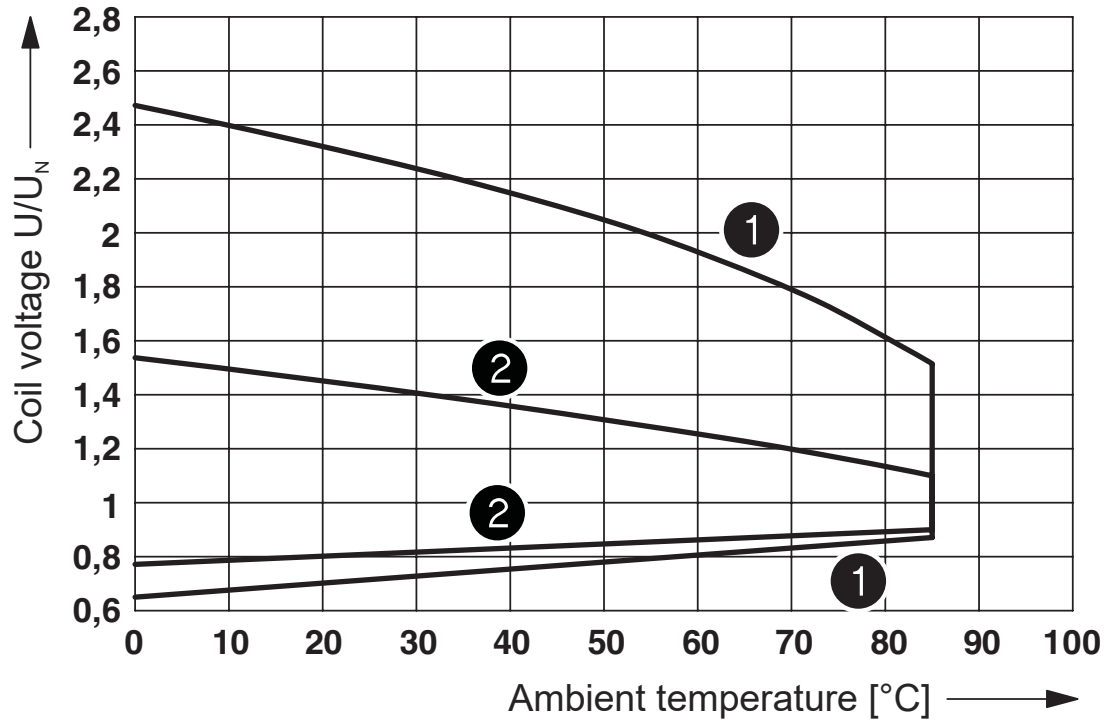

- ① DC coils
- ② AC coils

Operating voltage range

# REL-MR- 12DC/21-21AU - Single relay



2961299

<https://www.phoenixcontact.com/in/products/2961299>

## Approvals



**cUL Recognized**  
Approval ID: FILE E 228652



**UL Recognized**  
Approval ID: FILE E 228652



**EAC**  
Approval ID: TR\_TS\_D\_00573\_c



**UL Recognized**  
Approval ID: FILE E 228652



**EAC**  
Approval ID: RU\*C-DE.\*08.B.00010



**VDE Zeichengenehmigung**  
Approval ID: 40007758



**VDE Zeichengenehmigung**  
Approval ID: 40048281



**PRS**  
Approval ID: TE/2109/880590/16



**cUL Recognized**  
Approval ID: FILE E 228652

# REL-MR- 12DC/21-21AU - Single relay



2961299

<https://www.phoenixcontact.com/in/products/2961299>

## Classifications

### ECLASS

ECLASS-11.0	27371601
ECLASS-12.0	27371601
ECLASS-13.0	27371601

### ETIM

ETIM 8.0	EC001437
----------	----------

### UNSPSC

UNSPSC 21.0	39122300
-------------	----------

# REL-MR- 12DC/21-21AU - Single relay



2961299

<https://www.phoenixcontact.com/in/products/2961299>

## Environmental Product Compliance

China RoHS	Environmentally friendly use period: unlimited = EFUP-e
	No hazardous substances above threshold values

# REL-MR- 12DC/21-21AU - Single relay



2961299

<https://www.phoenixcontact.com/in/products/2961299>

## Accessories

### PLC-BPT- 12DC/21-21 - Relay base

2900282

<https://www.phoenixcontact.com/in/products/2900282>



14 mm PLC basic terminal block with Push-in connection, without relay or solid-state relay, for mounting on DIN rail NS 35/7,5, 2 changeover contacts, input voltage 12 V DC

---

### PLC-BSC- 12DC/21-21 - Relay base

2967251

<https://www.phoenixcontact.com/in/products/2967251>



14 mm PLC basic terminal block with screw connection, without relay or solid-state relay, for mounting on DIN rail NS 35/7,5, 2 changeover contacts, input voltage 12 V DC

# REL-MR- 12DC/21-21AU - Single relay



2961299

<https://www.phoenixcontact.com/in/products/2961299>

## RIF-1-BPT/2X21 - Relay base

2900931

<https://www.phoenixcontact.com/in/products/2900931>



Relay base RIF-1..., for miniature power relay with 1 or 2 changeover contacts or solid-state relays of the same design, Push-in connection, plug-in option for input/interference suppression modules, for mounting on NS 35/7,5

---

## RIF-1-BSC/2X21 - Relay base

2900930

<https://www.phoenixcontact.com/in/products/2900930>



RIF-1... relay base, for miniature power relay with 1 or 2 changeover contacts or identical solid-state relays, screw connection, plug-in option for input/interference suppression modules, for mounting on NS 35/7,5

Phoenix Contact 2023 © - all rights reserved  
<https://www.phoenixcontact.com>

PHOENIX CONTACT (I) Pvt. Ltd.  
A-58/2, Okhla Industrial Area, Phase - II, New Delhi-110 020

+91.1275.71420  
[info@phoenixcontact.co.in](mailto:info@phoenixcontact.co.in)