

# REL-MR- 60DC/21 - Single relay



2961118

<https://www.phoenixcontact.com/in/products/2961118>

Please be informed that the data shown in this PDF document is generated from our Online Catalog. Please find the complete data in the user documentation. Our General Terms of Use for Downloads are valid.

Plug-in miniature power relay, with power contact, 1 changeover contact, input voltage 60 V DC

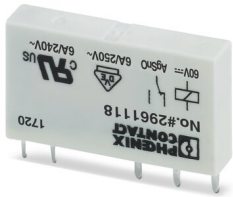

## Your advantages

- Safe isolation according to DIN EN 50178 between coil and contact
- High degree of protection up to RT III depending on type (wash-proof)
- Power contacts up to 6 A

## Commercial Data

Item number	2961118
Packing unit	10 pc
Minimum order quantity	10 pc
Sales Key	CK6
Product Key	CK6195
Catalog Page	Page 394 (C-5-2019)
GTIN	4017918130886
Weight per Piece (including packing)	6.86 g
Weight per Piece (excluding packing)	6.6 g
Customs tariff number	85364900
Country of origin	CZ

# REL-MR- 60DC/21 - Single relay



2961118

<https://www.phoenixcontact.com/in/products/2961118>

## Technical Data

### Product properties

Product type	Single relay
Set comprises	2966139 PLC-RSC- 60DC/21
	2966197 PLC-RSC-120UC/21
	2980021 PLC-RSC-125DC/21
	2966207 PLC-RSC-230UC/21
	2966511 PLC-RSP- 60DC/21
	2966524 PLC-RSP-120UC/21
	2966537 PLC-RSP-230UC/21
	2900303 PLC-RPT- 60DC/21
	2900304 PLC-RPT-120UC/21
	2900305 PLC-RPT-230UC/21
	2987053 PLC-RSP-110UC/21/RW
2900320 PLC-RPT-110UC/21/RW	
Operating mode	100% operating factor
Mechanical service life	2x 10 <sup>7</sup> cycles

### Insulation characteristics

Overvoltage category	III
Pollution degree	3

### Electrical properties

Maximum power dissipation for nominal condition	0.18 W
Test voltage (Winding/contact)	4 kV AC (50 Hz, 1 min., winding/contact)

### Input data

#### Coil side

Nominal input voltage U <sub>N</sub>	60 V DC
Input voltage range	36 V DC ... 165 V DC
Typical input current at U <sub>N</sub>	3 mA
Typical response time	5 ms
Typical release time	2.5 ms
Coil resistance	20500 Ω ±15 % (at 20 °C)

### Output data

#### Switching

Contact type	1 changeover contact
Type of switch contact	Single contact
Drive and function	monostable
Drive (polarity)	bipolar
Contact material	AgSnO

# REL-MR- 60DC/21 - Single relay

2961118

<https://www.phoenixcontact.com/in/products/2961118>

Maximum switching voltage	250 V AC/DC
Minimum switching voltage	5 V (at 100 mA)
Limiting continuous current	6 A
Maximum inrush current	10 A (4 s)
Min. switching current	10 mA (at 12 V)
Interrupting rating (ohmic load) max.	140 W (at 24 V DC)
	20 W (at 48 V DC)
	18 W (at 60 V DC)
	23 W (at 110 V DC)
	40 W (at 220 V DC)
	1500 VA (for 250 V AC)
Switching capacity	2 A (at 24 V, DC13)
	0.2 A (at 110 V, DC13)
	0.1 A (at 220 V, DC13)
	3 A (at 24 V, AC15)
	3 A (at 120 V, AC15)
	3 A (at 230 V, AC15)
Motor load according to UL 508	1/4 HP, 240 - 277 V AC (N/O contact)
	1/6 HP, 240 - 277 V AC (N/C contact)

## Connection data

Connection method	Plug / solder connection
-------------------	--------------------------

## Dimensions

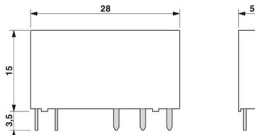
Dimensional drawing	
Width	5 mm
Height	28 mm
Depth	15 mm

## Environmental and real-life conditions

### Ambient conditions

Degree of protection	RT III
Ambient temperature (operation)	-40 °C ... 85 °C
Ambient temperature (storage/transport)	-40 °C ... 85 °C

## Approvals

### Corrosive gas test

Identification	ISA-S71.04. G3 Harsh Group
	EN 60068-2-60

# REL-MR- 60DC/21 - Single relay



2961118

<https://www.phoenixcontact.com/in/products/2961118>

## Standards and regulations

Standards/regulations	IEC 60664
	EN 50178
	EN 61810-1

## Mounting

Assembly instructions	in rows with zero spacing
Mounting position	any

Drawings

Diagram

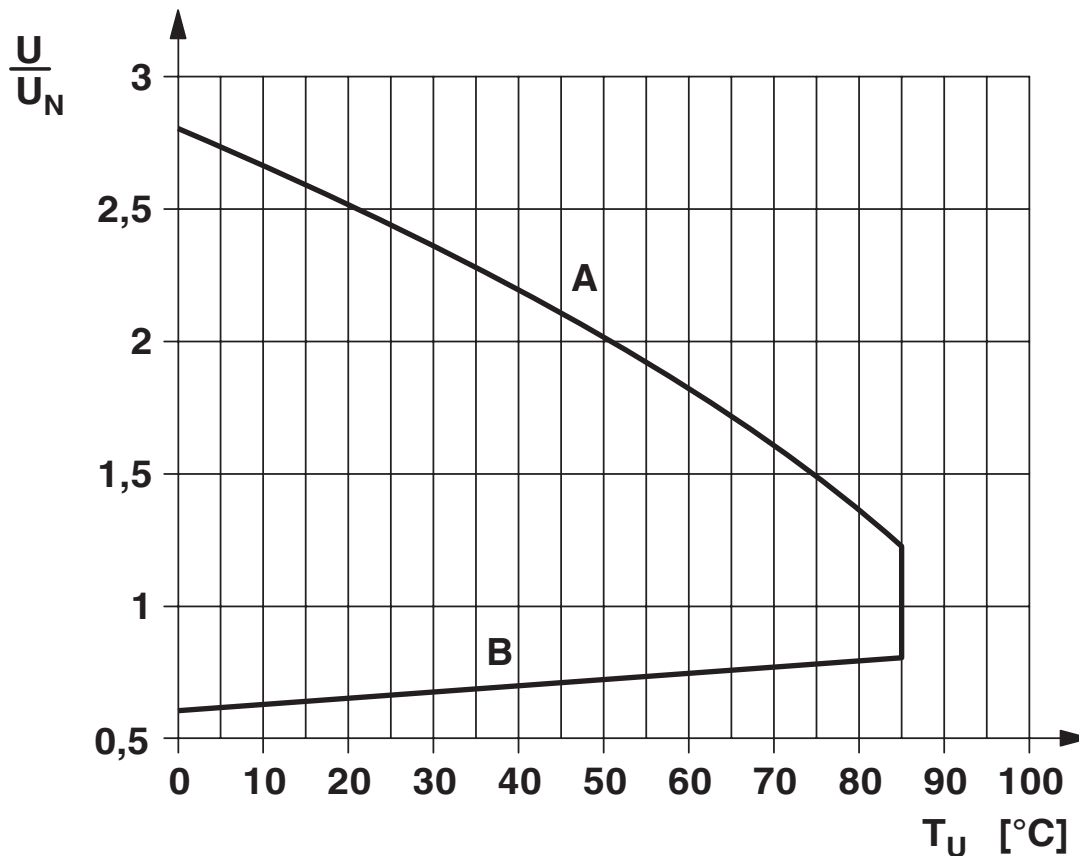

Operating voltage range

Drilling plan/solder pad geometry

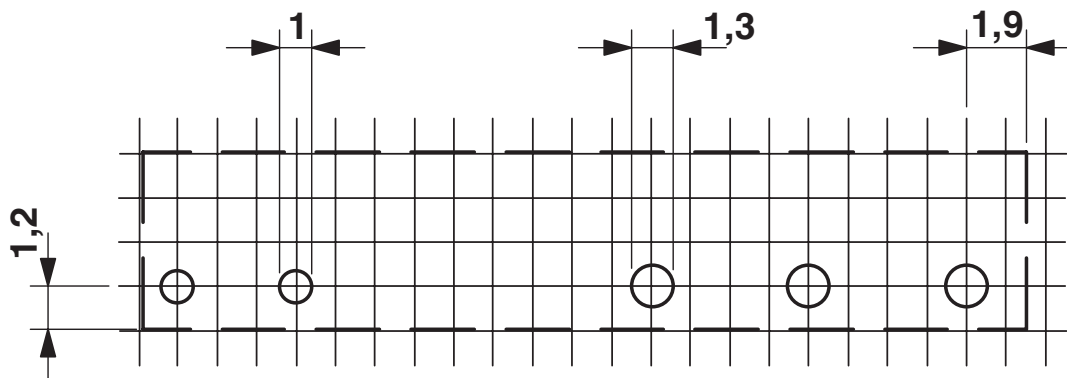

a = pitch division 1.25 mm and 1.27 mm

# REL-MR- 60DC/21 - Single relay

2961118

<https://www.phoenixcontact.com/in/products/2961118>

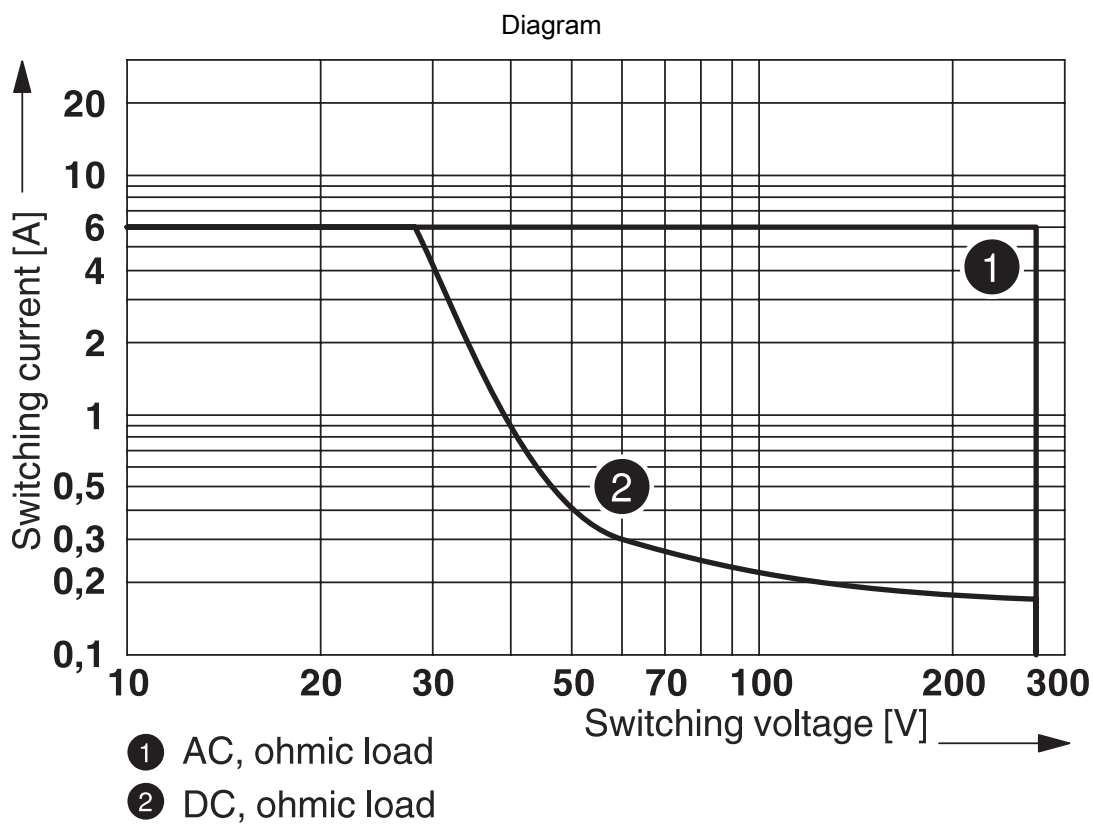
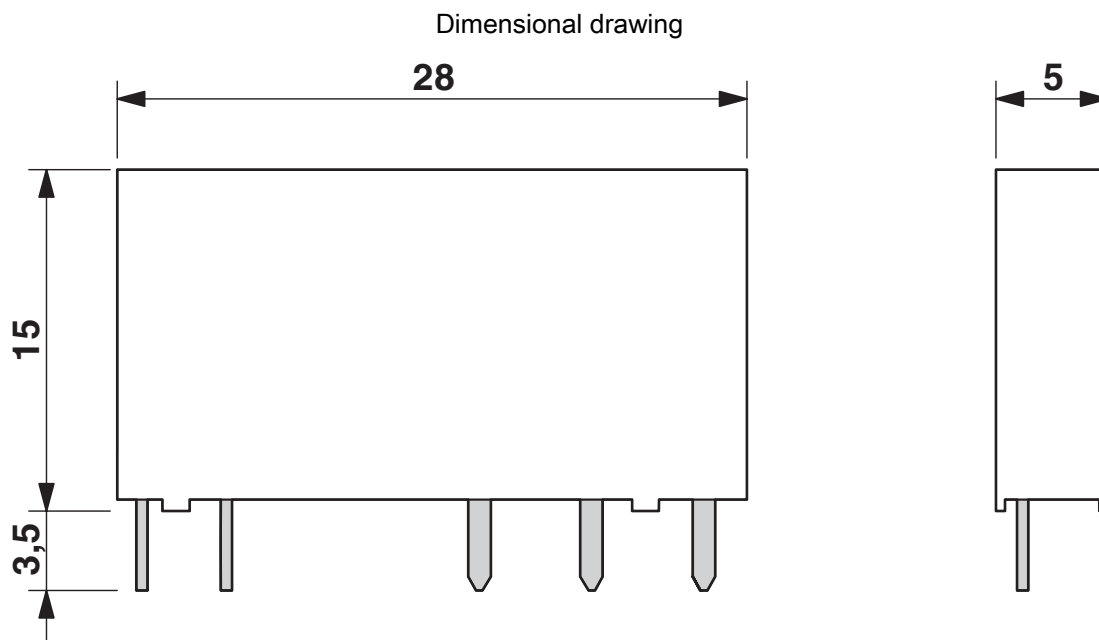

Interrupting rating

Diagram

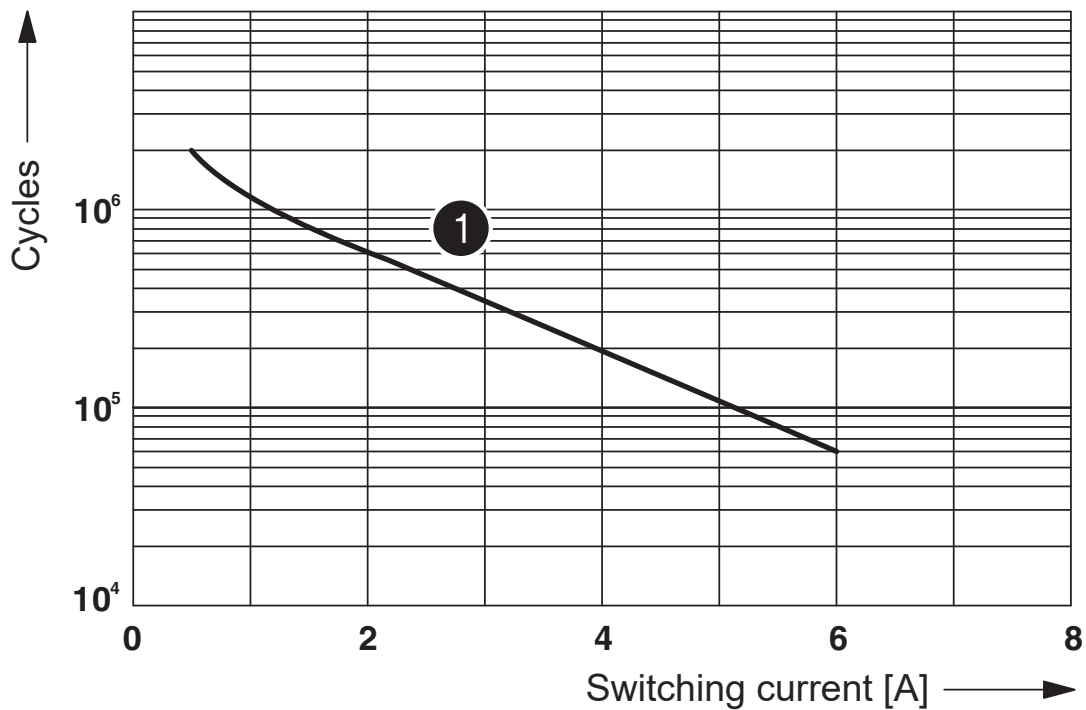

① 250 V AC, ohmic load

Electrical service life

Circuit diagram

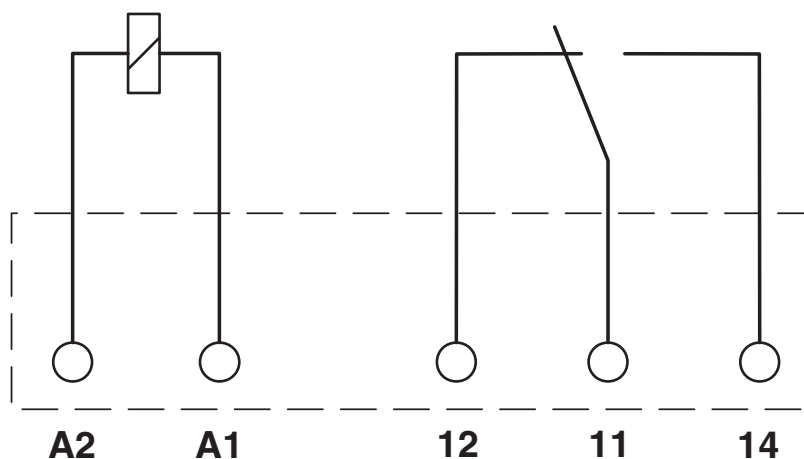

# REL-MR- 60DC/21 - Single relay



2961118

<https://www.phoenixcontact.com/in/products/2961118>

## Approvals



**cUL Recognized**  
Approval ID: FILE E 172140



**UL Recognized**  
Approval ID: FILE E 172140



**EAC**  
Approval ID: TR\_TS\_D\_00573\_c



**UL Recognized**  
Approval ID: FILE E 172140



**EAC**  
Approval ID: RU\*C-DE.\*08.B.00010



**VDE Zeichengenehmigung**  
Approval ID: 40010212



**VDE Zeichengenehmigung**  
Approval ID: 40032864



**PRS**  
Approval ID: TE/2109/880590/16



**cUL Recognized**  
Approval ID: FILE E 172140



**VDE Zeichengenehmigung**  
Approval ID: 40054426



**cUL Recognized**  
Approval ID: FILE E 172140



**UL Recognized**  
Approval ID: FILE E 172140



# REL-MR- 60DC/21 - Single relay

2961118

<https://www.phoenixcontact.com/in/products/2961118>



# REL-MR- 60DC/21 - Single relay



2961118

<https://www.phoenixcontact.com/in/products/2961118>

## Classifications

### ECLASS

ECLASS-11.0	27371601
ECLASS-12.0	27371601
ECLASS-13.0	27371601

### ETIM

ETIM 8.0	EC001437
----------	----------

### UNSPSC

UNSPSC 21.0	39122300
-------------	----------

# REL-MR- 60DC/21 - Single relay



2961118

<https://www.phoenixcontact.com/in/products/2961118>

## Environmental Product Compliance

China RoHS	Environmentally friendly use period: unlimited = EFUP-e
	No hazardous substances above threshold values

# REL-MR- 60DC/21 - Single relay

2961118

<https://www.phoenixcontact.com/in/products/2961118>



## Accessories

### PLC-BPIT- 60DC/21 - Relay base

2900279

<https://www.phoenixcontact.com/in/products/2900279>



6.2 mm PLC basic terminal block with Push-in connection, without relay or solid-state relay, for mounting on DIN rail NS 35/7,5, 1 changeover contact, input voltage 60 V DC

---

### PLC-BSC- 60DC/21 - Relay base

2966100

<https://www.phoenixcontact.com/in/products/2966100>



6.2 mm PLC basic terminal block with screw connection, without relay or solid-state relay, for mounting on DIN rail NS 35/7,5, 1 changeover contact, input voltage 60 V DC

# REL-MR- 60DC/21 - Single relay

2961118

<https://www.phoenixcontact.com/in/products/2961118>



## PLC-BPT-120UC/21 - Relay base

2900280

<https://www.phoenixcontact.com/in/products/2900280>



6.2 mm PLC basic terminal block with Push-in connection, without relay or solid-state relay, for mounting on DIN rail NS 35/7,5, 1 changeover contact, input voltage 120 V AC/DC

---

## PLC-BSC-120UC/21 - Relay base

2966032

<https://www.phoenixcontact.com/in/products/2966032>



6.2 mm PLC basic terminal block with screw connection, without relay or solid-state relay, for mounting on DIN rail NS 35/7,5, 1 changeover contact, input voltage 120 V AC/DC

# REL-MR- 60DC/21 - Single relay

2961118

<https://www.phoenixcontact.com/in/products/2961118>



## PLC-BSC-125DC/21 - Relay base

2980018

<https://www.phoenixcontact.com/in/products/2980018>



6.2 mm PLC basic terminal block with screw connection, without relay or solid-state relay, for mounting on DIN rail NS 35/7,5, 1 changeover contact, input voltage 125 V DC

---

## PLC-BPT-230UC/21 - Relay base

2900281

<https://www.phoenixcontact.com/in/products/2900281>



6.2 mm PLC basic terminal block with Push-in connection, without relay or solid-state relay, for mounting on DIN rail NS 35/7,5, 1 changeover contact, input voltage 230 V AC/DC

# REL-MR- 60DC/21 - Single relay

2961118

<https://www.phoenixcontact.com/in/products/2961118>



## PLC-BSC-230UC/21 - Relay base

2966045

<https://www.phoenixcontact.com/in/products/2966045>



6.2 mm PLC basic terminal block with screw connection, without relay or solid-state relay, for mounting on DIN rail NS 35/7,5, 1 changeover contact, input voltage 230 V AC/DC

---

## PLC-BPT-120UC/ 1/SEN - Relay base

2900451

<https://www.phoenixcontact.com/in/products/2900451>



6.2 mm PLC basic terminal block for input functions with push-in connection, without relay or solid-state relay, for mounting on DIN rail NS 35/7,5, with sensor supply voltage distribution (BB), 1 N/O contact, input voltage 120 V AC/DC

# REL-MR- 60DC/21 - Single relay

2961118

<https://www.phoenixcontact.com/in/products/2961118>



## PLC-BSC-120UC/ 1/SEN - Relay base

2966074

<https://www.phoenixcontact.com/in/products/2966074>



6.2 mm PLC basic terminal block for input functions with screw connection, without relay or solid-state relay, for mounting on DIN rail NS 35/7,5, with sensor supply voltage distribution (BB), 1 N/O contact, input voltage 120 V AC/DC

---

## PLC-BPT-230UC/ 1/SEN - Relay base

2900452

<https://www.phoenixcontact.com/in/products/2900452>



6.2 mm PLC basic terminal block for input functions with push-in connection, without relay or solid-state relay, for mounting on DIN rail NS 35/7,5, with sensor supply voltage distribution (BB), 1 N/O contact, input voltage 230 V AC/DC



# REL-MR- 60DC/21 - Single relay

2961118

<https://www.phoenixcontact.com/in/products/2961118>



## PLC-BSC-230UC/ 1/SEN - Relay base

2966087

<https://www.phoenixcontact.com/in/products/2966087>



6.2 mm PLC basic terminal block for input functions with screw connection, without relay or solid-state relay, for mounting on NS 35/7,5 DIN rail, with sensor supply voltage distribution (BB), 1 N/O contact, input voltage: 230 V AC/DC

---

## PLC-BPT-120UC/21/SO46 - Relay base

2900453

<https://www.phoenixcontact.com/in/products/2900453>



6.2 mm PLC basic terminal block against interference currents/voltages on the control side with Push-in connection, without relay or solid-state relay, for mounting on DIN rail NS 35/7,5, with integrated RCZ filter, 1 changeover contact, input voltage 120 V AC

# REL-MR- 60DC/21 - Single relay

2961118

<https://www.phoenixcontact.com/in/products/2961118>



## PLC-BSC-120UC/21/SO46 - Relay base

2980319

<https://www.phoenixcontact.com/in/products/2980319>



6.2 mm PLC basic terminal block with protection against interference currents/voltages on the control side, with screw connection, without relay or solid-state relay, for mounting on DIN rail NS 35/7,5, with integrated RCZ filter, 1 changeover contact, input voltage 120 V AC

---

## PLC-BPT-230UC/21/SO46 - Relay base

2900455

<https://www.phoenixcontact.com/in/products/2900455>



6.2 mm PLC basic terminal block against interference currents/voltages on the control side with Push-in connection, without relay or solid-state relay, for mounting on DIN rail NS 35/7,5, with integrated RCZ filter, 1 changeover contact, input voltage 230 V AC

# REL-MR- 60DC/21 - Single relay

2961118

<https://www.phoenixcontact.com/in/products/2961118>



## PLC-BSC-230UC/21/SO46 - Relay base

2980335

<https://www.phoenixcontact.com/in/products/2980335>



6.2 mm PLC basic terminal block with protection against interference currents/voltages on the control side, with screw connection, without relay or solid-state relay, for mounting on DIN rail NS 35/7,5, with integrated RCZ filter, 1 changeover contact, input voltage 230 V AC

---

## PLC-BPT-120UC/ 1/SEN/SO46 - Relay base

2900456

<https://www.phoenixcontact.com/in/products/2900456>



6.2 mm PLC basic terminal block with interference current and interference voltage protection on the control side, with push-in connection, without relay or solid-state relay, with sensor supply voltage distribution (BB), 1 N/O contact, input voltage 120 V AC

# REL-MR- 60DC/21 - Single relay

2961118

<https://www.phoenixcontact.com/in/products/2961118>



## PLC-BSC-120UC/ 1/SEN/SO46 - Relay base

2980322

<https://www.phoenixcontact.com/in/products/2980322>



6.2 mm PLC basic terminal block with interference current and interference voltage protection on the control side, with screw connection, without relay or solid-state relay, with sensor supply voltage distribution (BB), 1 N/O contact, input voltage 120 V AC

---

## PLC-BPT-230UC/ 1/SEN/SO46 - Relay base

2900457

<https://www.phoenixcontact.com/in/products/2900457>



6.2 mm PLC basic terminal block with interference current and interference voltage protection on the control side, with push-in connection, without relay or solid-state relay, with sensor supply voltage distribution (BB), 1 N/O contact, input voltage 230 V AC

# REL-MR- 60DC/21 - Single relay

2961118

<https://www.phoenixcontact.com/in/products/2961118>



## PLC-BSC-230UC/ 1/SEN/SO46 - Relay base

2980348

<https://www.phoenixcontact.com/in/products/2980348>



6.2 mm PLC basic terminal block with interference current and interference voltage protection on the control side, with screw connection, without relay or solid-state relay, with sensor supply voltage distribution (BB), 1 N/O contact, input voltage 230 V AC

---

Phoenix Contact 2023 © - all rights reserved

<https://www.phoenixcontact.com>

PHOENIX CONTACT (I) Pvt. Ltd.

A-58/2, Okhla Industrial Area, Phase - II, New Delhi-110 020

+91.1275.71420

[info@phoenixcontact.co.in](mailto:info@phoenixcontact.co.in)