

# MINI MCR-2-RTD-UI - Resistance thermometer measuring transducer



2902049

<https://www.phoenixcontact.com/in/products/2902049>

Please be informed that the data shown in this PDF document is generated from our Online Catalog. Please find the complete data in the user documentation. Our General Terms of Use for Downloads are valid.



Configurable temperature transducer with plug-in connection technology for connecting 2, 3, and 4-conductor resistance thermometers and resistance-type sensors. Configurable via DIP switch or software. Screw connection technology, standard configuration

## Product Description

Configurable, 3-way isolated temperature transducer with plug-in connection technology. The device is suitable for the connection of resistance thermometers and remote resistance-type sensors with 2, 3, and 4-conductor connection technology. The measured values are converted into a linear and freely adjustable current or voltage signal. You can configure the device using one of the free software solutions. Default settings can also be made directly on the device by simply using the DIP switches (see configuration table). The measuring transducer supports fault monitoring and NFC communication.

## Commercial Data

Item number	2902049
Packing unit	1 pc
Minimum order quantity	1 pc
Sales Key	CK1
Product Key	CK1421
Catalog Page	Page 82 (C-5-2019)
GTIN	4046356649759
Weight per Piece (including packing)	126.1 g
Weight per Piece (excluding packing)	110 g
Customs tariff number	85437090
Country of origin	DE

# MINI MCR-2-RTD-UI - Resistance thermometer measuring transducer



2902049

<https://www.phoenixcontact.com/in/products/2902049>

## Technical Data

### Notes

#### Utilization restriction

EMC note	EMC: class A product, see manufacturer's declaration in the download area
----------	---

### Product properties

Product type	Temperature transmitter
Product family	MINI Analog Pro
Type	Signal conditioner
Configuration	DIP switches
	Software
	App

#### Insulation characteristics

Overvoltage category	II
Pollution degree	2

### Electrical properties

Electrical isolation	3-way isolation
Protective circuit	Transient protection
Step response (0–99%)	200 ms (2-conductor)
	500 ms (3-conductor)
	500 ms (4-conductor)
Maximum temperature coefficient	0.01 %/K
Transmission error resistance-type sensor	2 Ω
Transmission error resistance thermometer	0.1 % * 350 K / set measuring range; 0.1 % > 350 K (Pt/Ni)
	0.3 % * 200 K / set measuring range; 0.3 % > 200 K (Cu)

#### Electrical isolation Input/output/power supply

Rated insulation voltage	300 V <sub>rms</sub>
Test voltage	3 kV AC (50 Hz, 60 s)
Insulation	Reinforced insulation according to IEC/EN 61010-1

#### Supply

Supply voltage range	9.6 V DC ... 30 V DC (The DIN rail connector (ME 6,2 TBUS-2 1,5/5-ST-3,81 GN, item no. 2869728) can be used to bridge the supply voltage. It can be snapped onto a 35 mm DIN rail in accordance with EN 60715)
Typical current consumption	32 mA (24 V DC)
	63 mA (12 V DC)
Power consumption	≤ 850 mW (at I <sub>OUT</sub> = 20 mA, 9.6 V DC, 600 Ω load)

# MINI MCR-2-RTD-UI - Resistance thermometer measuring transducer



2902049

<https://www.phoenixcontact.com/in/products/2902049>

## Input data

### Signal

Number of inputs	1
------------------	---

### Measurement

Number of inputs	1
Configurable/programmable	Yes
Sensor types (RTD) that can be used	Pt, Ni, Cu sensors
Temperature measuring range	-200 °C ... 850 °C (Range depends on sensor type, range can be set freely via software or in increments from -150°C to 850°C via DIP switches)
Temperature measuring range	≥ 20 K
Sensor input current	approx. 200 µA
Max. permissible overall conductor resistance	≤ 25 Ω (Per line, RTD in 3- or 4-conductor technology) ≤ 50 Ω (adjustable, RTD in 2-conductor technology)
Linear resistance measuring range	0 Ω ... 4000 Ω (Minimum measuring span: 10% of the selected measuring range)
Connection technology	2-, 3-, 4-conductor

## Output data

### Signal: Voltage/current

Number of outputs	1
Configurable/programmable	Yes
Voltage output signal	0 V ... 5 V (via DIP switch) 1 V ... 5 V (via DIP switch) 0 V ... 10 V (via DIP switch) 10 V ... 0 V (via DIP switch) 0 V ... 10.5 V (can be set via software)
Max. voltage output signal	approx. 12.3 V
Non-load voltage	< 17.5 V
Current output signal	0 mA ... 20 mA (via DIP switch) 4 mA ... 20 mA (via DIP switch) 20 mA ... 0 mA (via DIP switch) 20 mA ... 4 mA (via DIP switch) 0 mA ... 21 mA (can be set via software)
Max. current output signal	24.6 mA
Short-circuit current	< 31.5 mA
Load/output load voltage output	≥ 10 kΩ
Load/output load current output	≤ 600 Ω (at 20 mA)
Ripple	< 10 mV <sub>rms</sub> < 10 mV <sub>rms</sub> (at 600 Ω)
Resolution, outputs (voltage)	1 mV

# MINI MCR-2-RTD-UI - Resistance thermometer measuring transducer



2902049

<https://www.phoenixcontact.com/in/products/2902049>

Resolution, outputs (current)	2 $\mu$ A
Behavior in the event of a sensor error	configurable

## Connection data

Connection method	Screw connection
Stripping length	10 mm
Screw thread	M3
Conductor cross section rigid	0.2 mm <sup>2</sup> ... 1.5 mm <sup>2</sup> (with ferrule) 0.14 mm <sup>2</sup> ... 2.5 mm <sup>2</sup> (without ferrule)
Conductor cross section flexible	0.14 mm <sup>2</sup> ... 2.5 mm <sup>2</sup>
Conductor cross section AWG	24 ... 12 (flexible)
Tightening torque	0.5 Nm ... 0.6 Nm

## Ex data

Ex installation (EPL)	Gc Div. 2
-----------------------	--------------

## Interfaces

Data: IFS interface

Connection method	Micro USB type B
-------------------	------------------

## Signaling

Status display	Green LED (supply voltage)
Error indication	Red LED

## Dimensions

Width	6.2 mm
Height	109.81 mm
Depth	119.2 mm

## Material specifications

Fire protection for rail vehicles (DIN EN 45545-2) R22	HL 1 - HL 2
Fire protection for rail vehicles (DIN EN 45545-2) R23	HL 1 - HL 2
Fire protection for rail vehicles (DIN EN 45545-2) R24	HL 1 - HL 2
Housing material	PBT

## Environmental and real-life conditions

Ambient conditions

Degree of protection	IP20 (not assessed by UL)
Ambient temperature (operation)	-40 °C ... 70 °C
Ambient temperature (storage/transport)	-40 °C ... 85 °C
Altitude	≤ 2000 m

# MINI MCR-2-RTD-UI - Resistance thermometer measuring transducer



2902049

<https://www.phoenixcontact.com/in/products/2902049>

Permissible humidity (operation)	5 % ... 95 % (non-condensing)
----------------------------------	-------------------------------

## Approvals

### CE

Certificate	CE-compliant
-------------	--------------

### ATEX

Identification	<input type="checkbox"/> II 3 G Ex ec IIC T4 Gc
Certificate	BVS 20 ATEX E 024 X

### UKCA Ex (UKEX)

Identification	<input type="checkbox"/> II 3 G Ex ec IIC T4 Gc
Certificate	PxCIF21UKEX2902049X

### IECEX

Identification	Ex ec IIC T4 Gc
Certificate	IECEX BVS 20.0017X

### UL, USA/Canada

Identification	UL 508 Listed
	Class I, Div. 2, Groups A, B, C, D T6
	Class I, Zone 2, Group IIC T6

### Shipbuilding approval

Certificate	DNV GL TAA00002UA
-------------	-------------------

### EAC Ex

Identification	<input type="checkbox"/> 2Ex ec IIC T4 Gc
Certificate	BY/112 02.01 TP012 103.01 00079

### DNV GL data

Temperature	B
Humidity	B
Vibration	A
EMC	A
Enclosure	Required protection according to the Rules shall be provided upon installation on board

## EMC data

Noise immunity	EN 61000-6-2
Note	When being exposed to interference, there may be minimal deviations.
Electromagnetic compatibility	Conformance with EMC directive
Noise emission	EN 61000-6-4

### Electrostatic discharge

Standards/regulations	EN 61000-4-2
-----------------------	--------------

# MINI MCR-2-RTD-UI - Resistance thermometer measuring transducer



2902049

<https://www.phoenixcontact.com/in/products/2902049>

## Electrostatic discharge

Comments	Safety measures must be taken to prevent electrostatic discharge.
----------	---

## Electromagnetic HF field

Designation	Electromagnetic RF field
Standards/regulations	EN 61000-4-3
Typical deviation from the measuring range final value	0.06 %

## Fast transients (burst)

Designation	Fast transients (burst)
Standards/regulations	EN 61000-4-4
Typical deviation from the measuring range final value	0.1 %

## Surge current load (surge)

Standards/regulations	EN 61000-4-5
-----------------------	--------------

## Conducted interference

Designation	Conducted interferences
Standards/regulations	EN 61000-4-6
Typical deviation from the measuring range final value	0.07 %

## Standards and regulations

Electrical isolation	3-way isolation
----------------------	-----------------

## Mounting

Mounting type	DIN rail mounting
Assembly instructions	The DIN rail connector can be used for bridging the supply voltage. It can be snapped onto a 35 mm EN 60715 DIN rail.
Mounting position	any

# MINI MCR-2-RTD-UI - Resistance thermometer measuring transducer

2902049

<https://www.phoenixcontact.com/in/products/2902049>

## Drawings

Block diagram

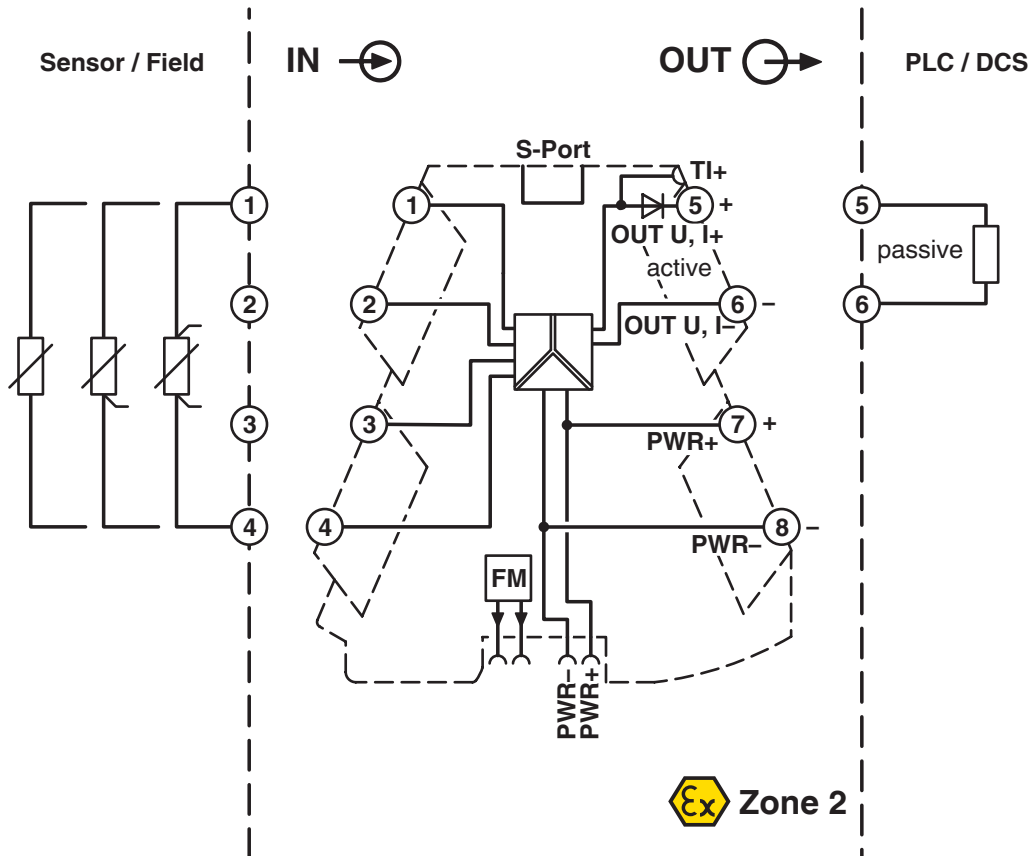

# MINI MCR-2-RTD-UI - Resistance thermometer measuring transducer



2902049

<https://www.phoenixcontact.com/in/products/2902049>

## Approvals



**DNV GL**

Approval ID: TAA00002UA



**UL Listed**

Approval ID: FILE E 238705



**cUL Listed**

Approval ID: FILE E 238705



**IECEx**

Approval ID: IECEx\_BVS\_20.0017X



**cUL Listed**

Approval ID: FILE E 196811



**UL Listed**

Approval ID: FILE E 196811



**ATEX**

Approval ID: BVS 20 ATEX E 024 X



# MINI MCR-2-RTD-UI - Resistance thermometer measuring transducer



2902049

<https://www.phoenixcontact.com/in/products/2902049>

## Classifications

### ECLASS

ECLASS-11.0	27210129
ECLASS-12.0	27210129
ECLASS-13.0	27210129

### ETIM

ETIM 8.0	EC002919
----------	----------

### UNSPSC

UNSPSC 21.0	41112100
-------------	----------

# MINI MCR-2-RTD-UI - Resistance thermometer measuring transducer



2902049

<https://www.phoenixcontact.com/in/products/2902049>

## Environmental Product Compliance

REACH SVHC	Lead 7439-92-1
China RoHS	Environmentally Friendly Use Period = 50 years
	For information on hazardous substances, refer to the manufacturer's declaration available under "Downloads"

# MINI MCR-2-RTD-UI - Resistance thermometer measuring transducer



2902049

<https://www.phoenixcontact.com/in/products/2902049>

## Accessories

### TC-D37SUB-AIO16-MP-PS-UNI - Module carrier

2906640

<https://www.phoenixcontact.com/in/products/2906640>

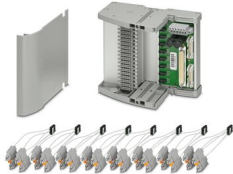

Universal Termination Carrier for connecting 16 MINI Analog Pro signal conditioners to digital or analog I/O cards, via D-SUB connector, 37-pos. (1:1 connection), with HART multiplexer connection

### TC-D37SUB-ADIO16-MP-P-UNI - Module carrier

2906639

<https://www.phoenixcontact.com/in/products/2906639>

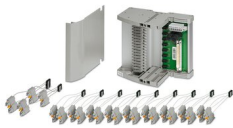

Universal Termination Carrier for connecting 16 MINI Analog Pro signal conditioners to digital or analog I/O cards, via D-SUB connector, 37-pos. (1:1 connection)

# MINI MCR-2-RTD-UI - Resistance thermometer measuring transducer

2902049

<https://www.phoenixcontact.com/in/products/2902049>

## ME 6,2 TBUS-2 1,5/5-ST-3,81 GY - DIN rail bus connectors

2695439

<https://www.phoenixcontact.com/in/products/2695439>

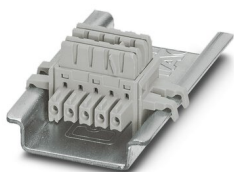

DIN rail connector (TBUS), 5-pos., for bridging the supply voltage, can be snapped onto NS 35/... DIN rail in accordance with EN 60715

---

## QUINT4-SYS-PS/1AC/24DC/2.5/SC - Power supply unit

2904614

<https://www.phoenixcontact.com/in/products/2904614>



Primary-switched power supply, QUINT POWER, screw connection, DIN rail mounting, supply of devices possible via the TBUS DIN rail connector, protective coating, input: single-phase, output: 24 V DC/2.5 A

# MINI MCR-2-RTD-UI - Resistance thermometer measuring transducer

2902049

<https://www.phoenixcontact.com/in/products/2902049>

## ME 6,2 TBUS-2 1,5/5-ST-3,81 GN - DIN rail bus connectors

2869728

<https://www.phoenixcontact.com/in/products/2869728>

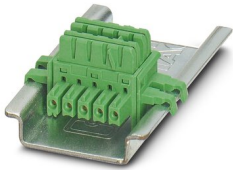

DIN rail connector for DIN rail mounting. Universal for TBUS housing. Gold-plated contacts, 5-pos.

---

## MINI MCR-2-PTB - Power terminal block

2902066

<https://www.phoenixcontact.com/in/products/2902066>



Power terminal with plug-in connection technology for delivering the supply voltage to the DIN rail connector. Monitoring of the supply voltages in combination with the fault monitoring module. Screw connection technology

# MINI MCR-2-RTD-UI - Resistance thermometer measuring transducer

2902049

<https://www.phoenixcontact.com/in/products/2902049>

## MINI MCR-2-PTB-PT - Power terminal block

2902067

<https://www.phoenixcontact.com/in/products/2902067>



Power terminal with plug-in connection technology for delivering the supply voltage to the DIN rail connector. Monitoring of the supply voltages in combination with the fault monitoring module. Push-in connection technology

---

## MINI MCR-2-FM-RC - Monitoring module

2904504

<https://www.phoenixcontact.com/in/products/2904504>



Fault monitoring module with plug-in connection technology for evaluating and reporting group errors from the FM system and for monitoring the supply voltages. Error message via N/C contact. Screw connection technology, standard configuration

# MINI MCR-2-RTD-UI - Resistance thermometer measuring transducer

2902049

<https://www.phoenixcontact.com/in/products/2902049>

## MINI MCR-2-FM-RC-PT - Monitoring module

2904508

<https://www.phoenixcontact.com/in/products/2904508>



Fault monitoring module with plug-in connection technology for evaluating and reporting group errors from the FM system and for monitoring the supply voltages. Error message via N/C contact. Push-in connection technology, standard configuration

---

## MINI MCR-2-V8-FLK 16 - System adapter

2901993

<https://www.phoenixcontact.com/in/products/2901993>

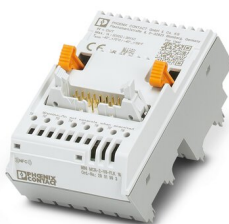

Eight MINI Analog Pro signal conditioners and measuring transducers can be connected to a controller with minimal cabling effort and without any errors using system adapters and system cabling.

# MINI MCR-2-RTD-UI - Resistance thermometer measuring transducer

2902049

<https://www.phoenixcontact.com/in/products/2902049>

## MINI MCR-2-V8-MOD-RTU - Communication module

2905634

<https://www.phoenixcontact.com/in/products/2905634>

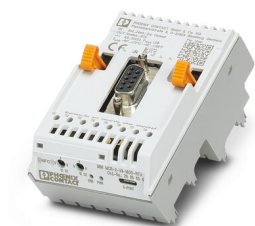

Eight MINI Analog Pro signal conditioners and measuring transducers are quickly and easily integrated into a Modbus/RTU network via a communication adapter.

---

## MINI MCR-2-V8-MOD-TCP - Communication module

2905635

<https://www.phoenixcontact.com/in/products/2905635>



Eight MINI Analog Pro signal conditioners and measuring transducers are quickly and easily integrated into a Modbus/TCP network via a communication adapter.



# MINI MCR-2-RTD-UI - Resistance thermometer measuring transducer

2902049

<https://www.phoenixcontact.com/in/products/2902049>

## MINI MCR-2-V8-PB-DP - Communication module

2905636

<https://www.phoenixcontact.com/in/products/2905636>



Eight MINI Analog Pro signal conditioners and measuring transducers are quickly and easily integrated into a PROFIBUS DP network via a communication adapter.

---

## MINI MCR-2-V8-PN - Communication module

2905637

<https://www.phoenixcontact.com/in/products/2905637>



Eight MINI Analog Pro signal conditioners and measuring transducers can be quickly and easily integrated into a PROFINET network via a communication adapter.

# MINI MCR-2-RTD-UI - Resistance thermometer measuring transducer

2902049

<https://www.phoenixcontact.com/in/products/2902049>

## IFS-USB-PROG-ADAPTER - Programming adapter

2811271

<https://www.phoenixcontact.com/in/products/2811271>



Programming adapter with USB interface, for programming with software. The USB driver is included in the software solutions for the products to be programmed, such as measuring transducers or motor managers.

---

## IFS-BT-PROG-ADAPTER - Adapter

2905872

<https://www.phoenixcontact.com/in/products/2905872>



Bluetooth adapter with micro USB and S-PORT interface for wireless communication with the MINI Analog, MINI Analog Pro, MACX Analog, Interface System Gateways, and PLC logic device series.

# MINI MCR-2-RTD-UI - Resistance thermometer measuring transducer

2902049

<https://www.phoenixcontact.com/in/products/2902049>

## TWN4 MIFARE NFC USB ADAPTER - Programming adapter

2909681

<https://www.phoenixcontact.com/in/products/2909681>



Near Field Communication (NFC) programming adapter with USB interface for the wireless configuration of NFC-capable products from Phoenix Contact with software. A separate USB driver is not required.

---

## FASTCON PRO-SET - Connector set

2906227

<https://www.phoenixcontact.com/in/products/2906227>



FASTCON Pro plug set consisting of four plugs with screw connection, one for each position on the module. Suitable for all MINI Analog Pro modules.

# MINI MCR-2-RTD-UI - Resistance thermometer measuring transducer

2902049

<https://www.phoenixcontact.com/in/products/2902049>

## FASTCON PRO-SET-PT - Connector set

2906228

<https://www.phoenixcontact.com/in/products/2906228>



FASTCON Pro plug set consisting of four plugs with push-in connection, one for each position on the module. Suitable for all MINI Analog Pro modules.

---

## UCT-EM (30X5) - Marker for end clamp

0801505

<https://www.phoenixcontact.com/in/products/0801505>



Marker for end clamp, Sheet, white, unlabeled, can be labeled with: TOPMARK NEO, TOPMARK LASER, BLUEMARK ID COLOR, BLUEMARK ID, BLUEMARK CLED, THERMOMARK PRIME, THERMOMARK CARD 2.0, THERMOMARK CARD, mounting type: snapped, lettering field size: 30 x 5 mm, Number of individual labels: 24

# MINI MCR-2-RTD-UI - Resistance thermometer measuring transducer



2902049

<https://www.phoenixcontact.com/in/products/2902049>

## UCT-EM (30X5) CUS - Marker for end clamp

0801589

<https://www.phoenixcontact.com/in/products/0801589>



Marker for end clamp, can be ordered: by sheet, white, labeled according to customer specifications, mounting type: snapped into marker carrier, lettering field size: 30 x 5 mm, Number of individual labels: 24

---

## SK 5,0 WH:REEL - Marker strip

0805221

<https://www.phoenixcontact.com/in/products/0805221>



Marker strip, Roll, white, unlabeled, can be labeled with: THERMOMARK E.300 (D)/600 (D), THERMOMARK ROLL 2.0, THERMOMARK ROLL, THERMOMARK ROLL X1, THERMOMARK ROLLMASTER 300/600, THERMOMARK X1.2, mounting type: adhesive, for terminal block width: 5 mm, lettering field size: continuous x 5 mm, Number of individual labels: 90000

# MINI MCR-2-RTD-UI - Resistance thermometer measuring transducer

2902049

<https://www.phoenixcontact.com/in/products/2902049>

## UC-EMLP (15X5) - Plastic label

0819301

<https://www.phoenixcontact.com/in/products/0819301>



Plastic label, Sheet, white, unlabeled, can be labeled with: BLUEMARK ID COLOR, BLUEMARK ID, BLUEMARK CLED, PLOTMARK, CMS-P1-PLOTTER, mounting type: adhesive, lettering field size: 15 x 5 mm, Number of individual labels: 10

---

## UC-EMLP (15X5) YE - Plastic label

0822615

<https://www.phoenixcontact.com/in/products/0822615>

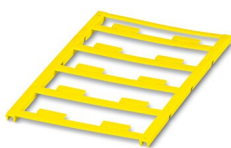

Plastic label, Sheet, yellow, unlabeled, can be labeled with: BLUEMARK ID COLOR, BLUEMARK ID, BLUEMARK CLED, PLOTMARK, CMS-P1-PLOTTER, mounting type: adhesive, lettering field size: 15 x 5 mm, Number of individual labels: 10

# MINI MCR-2-RTD-UI - Resistance thermometer measuring transducer



2902049

<https://www.phoenixcontact.com/in/products/2902049>

## UC-EMLP (15X5) CUS - Plastic label

0824550

<https://www.phoenixcontact.com/in/products/0824550>

Plastic label, can be ordered: by sheet, white, labeled according to customer specifications, mounting type: adhesive, lettering field size: 15 x 5 mm



---

## UC-EMLP (15X5) YE CUS - Plastic label

0824551

<https://www.phoenixcontact.com/in/products/0824551>

Plastic label, can be ordered: by sheet, yellow, labeled according to customer specifications, mounting type: adhesive, lettering field size: 15 x 5 mm

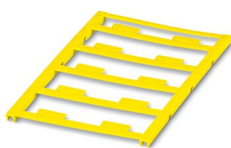

# MINI MCR-2-RTD-UI - Resistance thermometer measuring transducer

2902049

<https://www.phoenixcontact.com/in/products/2902049>

## UC-EMLP (15X5) SR - Plastic label

0828095

<https://www.phoenixcontact.com/in/products/0828095>



Plastic label, Sheet, silver, unlabeled, can be labeled with: BLUEMARK ID COLOR, BLUEMARK ID, BLUEMARK CLED, PLOTMARK, CMS-P1-PLOTTER, mounting type: adhesive, lettering field size: 15 x 5 mm, Number of individual labels: 10

---

## UC-EMLP (15X5) SR CUS - Plastic label

0828099

<https://www.phoenixcontact.com/in/products/0828099>



Plastic label, can be ordered: by sheet, silver, labeled according to customer specifications, mounting type: adhesive, lettering field size: 15 x 5 mm, Number of individual labels: 10



# MINI MCR-2-RTD-UI - Resistance thermometer measuring transducer

2902049

<https://www.phoenixcontact.com/in/products/2902049>

## US-EMLP (15X5) - Plastic label

0828790

<https://www.phoenixcontact.com/in/products/0828790>



Plastic label, Card, white, unlabeled, can be labeled with: BLUEMARK ID COLOR, BLUEMARK ID, THERMOMARK PRIME, THERMOMARK CARD 2.0, THERMOMARK CARD, mounting type: adhesive, lettering field size: 15 x 5 mm, Number of individual labels: 189

---

## US-EMLP (15X5) YE - Plastic label

0828873

<https://www.phoenixcontact.com/in/products/0828873>



Plastic label, Card, yellow, unlabeled, can be labeled with: BLUEMARK ID COLOR, BLUEMARK ID, THERMOMARK PRIME, THERMOMARK CARD 2.0, THERMOMARK CARD, mounting type: adhesive, lettering field size: 15 x 5 mm, Number of individual labels: 189

# MINI MCR-2-RTD-UI - Resistance thermometer measuring transducer

2902049

<https://www.phoenixcontact.com/in/products/2902049>

## US-EMLP (15X5) SR - Plastic label

0828874

<https://www.phoenixcontact.com/in/products/0828874>



Plastic label, Card, silver, unlabeled, can be labeled with: BLUEMARK ID COLOR, BLUEMARK ID, THERMOMARK PRIME, THERMOMARK CARD 2.0, THERMOMARK CARD, mounting type: adhesive, lettering field size: 15 x 5 mm, Number of individual labels: 189

---

## US-EMLP (15X5) CUS - Plastic label

0830076

<https://www.phoenixcontact.com/in/products/0830076>



Plastic label, can be ordered: by card, white, labeled according to customer specifications, mounting type: adhesive, lettering field size: 15 x 5 mm, Number of individual labels: 189

# MINI MCR-2-RTD-UI - Resistance thermometer measuring transducer



2902049

<https://www.phoenixcontact.com/in/products/2902049>

## US-EMLP (15X5) YE CUS - Plastic label

0830077

<https://www.phoenixcontact.com/in/products/0830077>

Plastic label, can be ordered: by card, yellow, labeled according to customer specifications, mounting type: adhesive, lettering field size: 15 x 5 mm, Number of individual labels: 189



---

## US-EMLP (15X5) SR CUS - Plastic label

0830078

<https://www.phoenixcontact.com/in/products/0830078>

Plastic label, can be ordered: by card, silver, labeled according to customer specifications, mounting type: adhesive, lettering field size: 15 x 5 mm, Number of individual labels: 189



# MINI MCR-2-RTD-UI - Resistance thermometer measuring transducer



2902049

<https://www.phoenixcontact.com/in/products/2902049>

## UCT-EM (30X5) YE - Marker for end clamp

0830340

<https://www.phoenixcontact.com/in/products/0830340>



Marker for end clamp, Sheet, yellow, unlabeled, can be labeled with: TOPMARK NEO, TOPMARK LASER, BLUEMARK ID COLOR, BLUEMARK ID, BLUEMARK CLED, THERMOMARK PRIME, THERMOMARK CARD 2.0, THERMOMARK CARD, mounting type: snapped, lettering field size: 30 x 5 mm, Number of individual labels: 24

---

## UCT-EM (30X5) YE CUS - Marker for end clamp

0830348

<https://www.phoenixcontact.com/in/products/0830348>



Marker for end clamp, can be ordered: by sheet, yellow, labeled according to customer specifications, mounting type: snapped into marker carrier, lettering field size: 30 x 5 mm, Number of individual labels: 24

---

Phoenix Contact 2023 © - all rights reserved

<https://www.phoenixcontact.com>

PHOENIX CONTACT (I) Pvt. Ltd.

A-58/2, Okhla Industrial Area, Phase - II, New Delhi-110 020

+91.1275.71420

[info@phoenixcontact.co.in](mailto:info@phoenixcontact.co.in)