

MINI MCR-2-U-I0 - Signal conditioner



2902022

<https://www.phoenixcontact.com/in/products/2902022>

Please be informed that the data shown in this PDF document is generated from our Online Catalog. Please find the complete data in the user documentation. Our General Terms of Use for Downloads are valid.



3-way signal conditioner with plug-in connection technology for the electrical isolation of analog signals. Input signal: 0 V ... 10 V, output signal: 0 mA ... 20 mA, screw connection technology

Product Description

Standard signal 3-way signal conditioner with plug-in connection technology for the electrical isolation, conversion, amplification, and filtering of standard signals. The measuring transducer supports fault monitoring and NFC communication.

Commercial Data

Item number	2902022
Packing unit	1 pc
Minimum order quantity	1 pc
Sales Key	CK1
Product Key	CK1411
Catalog Page	Page 76 (C-5-2019)
GTIN	4046356652001
Weight per Piece (including packing)	115.2 g
Weight per Piece (excluding packing)	104.4 g
Customs tariff number	85437090
Country of origin	DE

MINI MCR-2-U-I0 - Signal conditioner



2902022

<https://www.phoenixcontact.com/in/products/2902022>

Technical Data

Notes

Utilization restriction

EMC note	EMC: class A product, see manufacturer's declaration in the download area
----------	---

Product properties

Product type	Signal conditioner
Product family	MINI Analog Pro
No. of channels	1
Type	Signal conditioner

Insulation characteristics: GB Standard

Overvoltage category	II
Pollution degree	2

Electrical properties

No. of channels	1
Electrical isolation	3-way isolation
Electrical isolation between input and output	yes
Limit frequency (3 dB)	<input type="checkbox"/> 30 Hz
Protective circuit	Transient protection
Step response (10-90%)	<input type="checkbox"/> 10 ms
Maximum temperature coefficient	0.01 %/K
Temperature coefficient, typical	0.01 %/K
Maximum transmission error	0.1 % (of final value)

Electrical isolation Input/output/power supply

Rated insulation voltage	300 V _{rms}
Test voltage	3 kV AC (50 Hz, 60 s)
Insulation	Reinforced insulation according to IEC/EN 61010-1

Supply

Nominal supply voltage	24 V DC
Supply voltage range	9.6 V DC ... 30 V DC (The DIN rail connector (ME 6,2 TBUS-2 1,5/5-ST-3,81 GN, item no. 2869728) can be used to bridge the supply voltage. It can be snapped onto a 35 mm DIN rail in accordance with EN 60715)
Typical current consumption	25 mA (24 V DC) 54 mA (12 V DC)
Power consumption	≤ 800 mW (9.6 V DC)

Input data

Signal: Voltage

MINI MCR-2-U-I0 - Signal conditioner



2902022

<https://www.phoenixcontact.com/in/products/2902022>

Number of inputs	1
Configurable/programmable	no
Voltage input signal	0 V ... 10 V
Input resistance of voltage input	<input type="checkbox"/> 1 M Ω
Input resistance current input	<input type="checkbox"/> 63 Ω (+0.7 V for test diode)

Output data

Signal: Current

Number of outputs	1
Configurable/programmable	no
Non-load voltage	< 17 V
Current output signal	0 mA ... 20 mA
Max. current output signal	22 mA
Load/output load current output	\leq 600 Ω (20 mA)
Ripple	< 20 mV _{PP} (600 Ω)

Connection data

Connection method	Screw connection
Stripping length	10 mm
Screw thread	M3
Conductor cross section rigid	0.2 mm ² ... 1.5 mm ² (with ferrule) 0.14 mm ² ... 2.5 mm ² (without ferrule)
Conductor cross section flexible	0.14 mm ² ... 2.5 mm ²
Conductor cross section AWG	24 ... 12 (flexible)
Tightening torque	0.5 Nm ... 0.6 Nm

Ex data

Ex installation (EPL)	Gc Div. 2
-----------------------	--------------

Signaling

Status display	Green LED (supply voltage)
----------------	----------------------------

Dimensions

Width	6.2 mm
Height	109.81 mm
Depth	119.2 mm

Material specifications

Fire protection for rail vehicles (DIN EN 45545-2) R22	HL 1 - HL 2
Fire protection for rail vehicles (DIN EN 45545-2) R23	HL 1 - HL 2
Fire protection for rail vehicles (DIN EN 45545-2) R24	HL 1 - HL 2
Housing material	PBT

MINI MCR-2-U-I0 - Signal conditioner



2902022

<https://www.phoenixcontact.com/in/products/2902022>

Environmental and real-life conditions

Ambient conditions

Degree of protection	IP20 (not assessed by UL)
Ambient temperature (operation)	-40 °C ... 70 °C
Ambient temperature (storage/transport)	-40 °C ... 85 °C
Altitude	≤ 2000 m
Permissible humidity (operation)	5 % ... 95 % (non-condensing)

Approvals

CE

Certificate	CE-compliant
-------------	--------------

ATEX

Identification	<input type="checkbox"/> II 3 G Ex ec IIC T4 Gc
Certificate	BVS 19 ATEX E 047 X

UKCA Ex (UKEX)

Identification	<input type="checkbox"/> II 3 G Ex ec IIC T4 Gc
Certificate	PxCIF21UKEX2902000X

IECEX

Identification	Ex ec IIC T4 Gc
Certificate	IECEX BVS 19.0041X

CCC / China-Ex

Identification	Ex nA IIC T4 Gc
----------------	-----------------

UL, USA/Canada

Identification	UL 508 Listed
	Class I, Div. 2, Groups A, B, C, D T6
	Class I, Zone 2, Group IIC T6

Shipbuilding approval

Certificate	DNV GL TAA00002UA
-------------	-------------------

EAC Ex

Identification	<input type="checkbox"/> 2Ex ec IIC T4 Gc
Certificate	BY/112 02.01 TP012 103.01 00079

DNV GL data

Temperature	B
Humidity	B
Vibration	A
EMC	A
Enclosure	Required protection according to the Rules shall be provided upon installation on board

MINI MCR-2-U-I0 - Signal conditioner



2902022

<https://www.phoenixcontact.com/in/products/2902022>

EMC data

Noise immunity	EN 61000-6-2
Note	When being exposed to interference, there may be minimal deviations.
Electromagnetic compatibility	Conformance with EMC directive
Noise emission	EN 61000-6-4

Electrostatic discharge

Standards/regulations	EN 61000-4-2
-----------------------	--------------

Electrostatic discharge

Comments	Safety measures must be taken to prevent electrostatic discharge.
----------	---

Electromagnetic HF field

Designation	Electromagnetic RF field
Standards/regulations	EN 61000-4-3

Fast transients (burst)

Designation	Fast transients (burst)
Standards/regulations	EN 61000-4-4

Surge current load (surge)

Standards/regulations	EN 61000-4-5
-----------------------	--------------

Conducted interference

Designation	Conducted interferences
Standards/regulations	EN 61000-4-6

Standards and regulations

Electrical isolation	3-way isolation
----------------------	-----------------

GB Standard

Standards/regulations	GB 3836.1
	GB 3836.8

Mounting

Mounting type	DIN rail mounting
Assembly instructions	The DIN rail connector can be used for bridging the supply voltage. It can be snapped onto a 35 mm EN 60715 DIN rail.
Mounting position	any

MINI MCR-2-U-I0 - Signal conditioner

2902022

<https://www.phoenixcontact.com/in/products/2902022>

Drawings

Block diagram

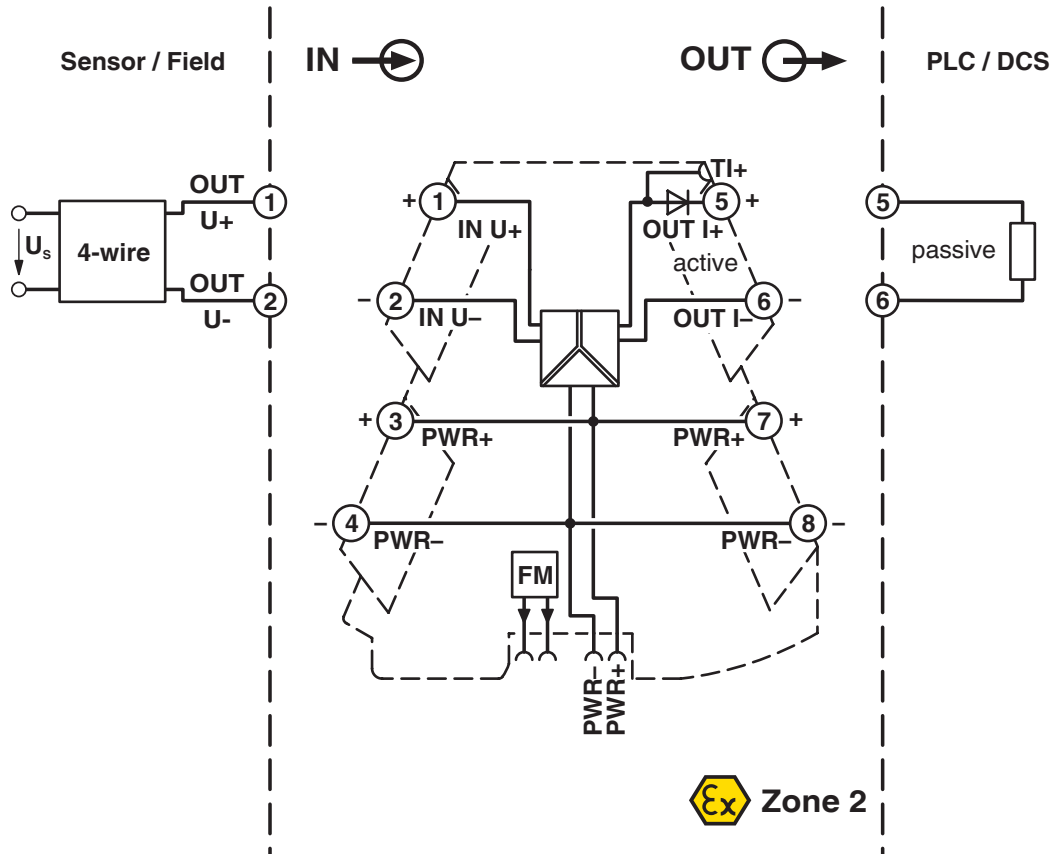

MINI MCR-2-U-I0 - Signal conditioner



2902022

<https://www.phoenixcontact.com/in/products/2902022>

Approvals



DNV GL

Approval ID: TAA00002UA



UL Listed

Approval ID: FILE E 238705



CCC

Approval ID: 2021322310003859



cUL Listed

Approval ID: FILE E 238705



IECEx

Approval ID: IECEx BVS 19.0041X



cUL Listed

Approval ID: FILE E 196811



UL Listed

Approval ID: FILE E 196811



ATEX

Approval ID: BVS 19 ATEX E 047 X

MINI MCR-2-U-I0 - Signal conditioner



2902022

<https://www.phoenixcontact.com/in/products/2902022>

Classifications

ECLASS

ECLASS-11.0	27210120
ECLASS-12.0	27210120
ECLASS-13.0	27210120

ETIM

ETIM 8.0	EC002653
----------	----------

UNSPSC

UNSPSC 21.0	39121000
-------------	----------

MINI MCR-2-U-I0 - Signal conditioner



2902022

<https://www.phoenixcontact.com/in/products/2902022>

Environmental Product Compliance

REACH SVHC	Lead 7439-92-1
China RoHS	Environmentally Friendly Use Period = 50 years
	For information on hazardous substances, refer to the manufacturer's declaration available under "Downloads"

MINI MCR-2-U-I0 - Signal conditioner



2902022

<https://www.phoenixcontact.com/in/products/2902022>

Accessories

TC-D37SUB-AIO16-MP-PS-UNI - Module carrier

2906640

<https://www.phoenixcontact.com/in/products/2906640>

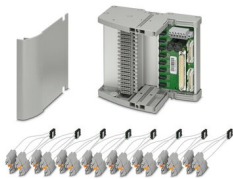

Universal Termination Carrier for connecting 16 MINI Analog Pro signal conditioners to digital or analog I/O cards, via D-SUB connector, 37-pos. (1:1 connection), with HART multiplexer connection

TC-D37SUB-ADIO16-MP-P-UNI - Module carrier

2906639

<https://www.phoenixcontact.com/in/products/2906639>



Universal Termination Carrier for connecting 16 MINI Analog Pro signal conditioners to digital or analog I/O cards, via D-SUB connector, 37-pos. (1:1 connection)

MINI MCR-2-U-I0 - Signal conditioner

2902022

<https://www.phoenixcontact.com/in/products/2902022>



ME 6,2 TBUS-2 1,5/5-ST-3,81 GY - DIN rail bus connectors

2695439

<https://www.phoenixcontact.com/in/products/2695439>

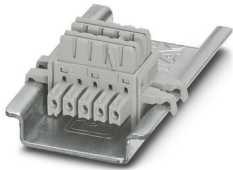

DIN rail connector (TBUS), 5-pos., for bridging the supply voltage, can be snapped onto NS 35/... DIN rail in accordance with EN 60715

QUINT4-SYS-PS/1AC/24DC/2.5/SC - Power supply unit

2904614

<https://www.phoenixcontact.com/in/products/2904614>



Primary-switched power supply, QUINT POWER, screw connection, DIN rail mounting, supply of devices possible via the TBUS DIN rail connector, protective coating, input: single-phase, output: 24 V DC/2.5 A

MINI MCR-2-U-I0 - Signal conditioner

2902022

<https://www.phoenixcontact.com/in/products/2902022>



ME 6,2 TBUS-2 1,5/5-ST-3,81 GN - DIN rail bus connectors

2869728

<https://www.phoenixcontact.com/in/products/2869728>

DIN rail connector for DIN rail mounting. Universal for TBUS housing. Gold-plated contacts, 5-pos.

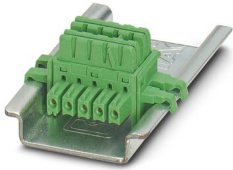

MINI MCR-2-PTB - Power terminal block

2902066

<https://www.phoenixcontact.com/in/products/2902066>

Power terminal with plug-in connection technology for delivering the supply voltage to the DIN rail connector. Monitoring of the supply voltages in combination with the fault monitoring module. Screw connection technology



MINI MCR-2-U-I0 - Signal conditioner

2902022

<https://www.phoenixcontact.com/in/products/2902022>



MINI MCR-2-PTB-PT - Power terminal block

2902067

<https://www.phoenixcontact.com/in/products/2902067>



Power terminal with plug-in connection technology for delivering the supply voltage to the DIN rail connector. Monitoring of the supply voltages in combination with the fault monitoring module. Push-in connection technology

MINI MCR-2-FM-RC - Monitoring module

2904504

<https://www.phoenixcontact.com/in/products/2904504>



Fault monitoring module with plug-in connection technology for evaluating and reporting group errors from the FM system and for monitoring the supply voltages. Error message via N/C contact. Screw connection technology, standard configuration

MINI MCR-2-U-I0 - Signal conditioner

2902022

<https://www.phoenixcontact.com/in/products/2902022>



MINI MCR-2-FM-RC-PT - Monitoring module

2904508

<https://www.phoenixcontact.com/in/products/2904508>



Fault monitoring module with plug-in connection technology for evaluating and reporting group errors from the FM system and for monitoring the supply voltages. Error message via N/C contact. Push-in connection technology, standard configuration

MINI MCR-2-V8-FLK 16 - System adapter

2901993

<https://www.phoenixcontact.com/in/products/2901993>



Eight MINI Analog Pro signal conditioners and measuring transducers can be connected to a controller with minimal cabling effort and without any errors using system adapters and system cabling.

MINI MCR-2-U-I0 - Signal conditioner

2902022

<https://www.phoenixcontact.com/in/products/2902022>



MINI MCR-2-V8-MOD-RTU - Communication module

2905634

<https://www.phoenixcontact.com/in/products/2905634>

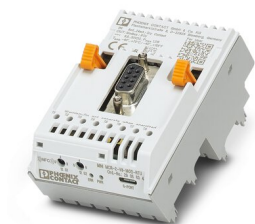

Eight MINI Analog Pro signal conditioners and measuring transducers are quickly and easily integrated into a Modbus/RTU network via a communication adapter.

MINI MCR-2-V8-MOD-TCP - Communication module

2905635

<https://www.phoenixcontact.com/in/products/2905635>



Eight MINI Analog Pro signal conditioners and measuring transducers are quickly and easily integrated into a Modbus/TCP network via a communication adapter.

MINI MCR-2-U-I0 - Signal conditioner

2902022

<https://www.phoenixcontact.com/in/products/2902022>



MINI MCR-2-V8-PB-DP - Communication module

2905636

<https://www.phoenixcontact.com/in/products/2905636>



Eight MINI Analog Pro signal conditioners and measuring transducers are quickly and easily integrated into a PROFIBUS DP network via a communication adapter.

MINI MCR-2-V8-PN - Communication module

2905637

<https://www.phoenixcontact.com/in/products/2905637>



Eight MINI Analog Pro signal conditioners and measuring transducers can be quickly and easily integrated into a PROFINET network via a communication adapter.

MINI MCR-2-U-I0 - Signal conditioner

2902022

<https://www.phoenixcontact.com/in/products/2902022>

FASTCON PRO-SET - Connector set

2906227

<https://www.phoenixcontact.com/in/products/2906227>



FASTCON Pro plug set consisting of four plugs with screw connection, one for each position on the module. Suitable for all MINI Analog Pro modules.

FASTCON PRO-SET-PT - Connector set

2906228

<https://www.phoenixcontact.com/in/products/2906228>



FASTCON Pro plug set consisting of four plugs with push-in connection, one for each position on the module. Suitable for all MINI Analog Pro modules.

MINI MCR-2-U-I0 - Signal conditioner

2902022

<https://www.phoenixcontact.com/in/products/2902022>

UCT-EM (30X5) - Marker for end clamp

0801505

<https://www.phoenixcontact.com/in/products/0801505>



Marker for end clamp, Sheet, white, unlabeled, can be labeled with: TOPMARK NEO, TOPMARK LASER, BLUEMARK ID COLOR, BLUEMARK ID, BLUEMARK CLED, THERMOMARK PRIME, THERMOMARK CARD 2.0, THERMOMARK CARD, mounting type: snapped, lettering field size: 30 x 5 mm, Number of individual labels: 24

UCT-EM (30X5) CUS - Marker for end clamp

0801589

<https://www.phoenixcontact.com/in/products/0801589>



Marker for end clamp, can be ordered: by sheet, white, labeled according to customer specifications, mounting type: snapped into marker carrier, lettering field size: 30 x 5 mm, Number of individual labels: 24

MINI MCR-2-U-I0 - Signal conditioner

2902022

<https://www.phoenixcontact.com/in/products/2902022>

SK 5,0 WH:REEL - Marker strip

0805221

<https://www.phoenixcontact.com/in/products/0805221>



Marker strip, Roll, white, unlabeled, can be labeled with: THERMOMARK E.300 (D)/600 (D), THERMOMARK ROLL 2.0, THERMOMARK ROLL, THERMOMARK ROLL X1, THERMOMARK ROLLMASTER 300/600, THERMOMARK X1.2, mounting type: adhesive, for terminal block width: 5 mm, lettering field size: continuous x 5 mm, Number of individual labels: 90000

UC-EMLP (15X5) - Plastic label

0819301

<https://www.phoenixcontact.com/in/products/0819301>



Plastic label, Sheet, white, unlabeled, can be labeled with: BLUEMARK ID COLOR, BLUEMARK ID, BLUEMARK CLED, PLOTMARK, CMS-P1-PLOTTER, mounting type: adhesive, lettering field size: 15 x 5 mm, Number of individual labels: 10

MINI MCR-2-U-I0 - Signal conditioner



2902022

<https://www.phoenixcontact.com/in/products/2902022>

UC-EMLP (15X5) YE - Plastic label

0822615

<https://www.phoenixcontact.com/in/products/0822615>

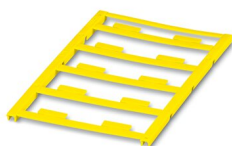

Plastic label, Sheet, yellow, unlabeled, can be labeled with: BLUEMARK ID COLOR, BLUEMARK ID, BLUEMARK CLED, PLOTMARK, CMS-P1-PLOTTER, mounting type: adhesive, lettering field size: 15 x 5 mm, Number of individual labels: 10

UC-EMLP (15X5) CUS - Plastic label

0824550

<https://www.phoenixcontact.com/in/products/0824550>



Plastic label, can be ordered: by sheet, white, labeled according to customer specifications, mounting type: adhesive, lettering field size: 15 x 5 mm

MINI MCR-2-U-I0 - Signal conditioner



2902022

<https://www.phoenixcontact.com/in/products/2902022>

UC-EMLP (15X5) YE CUS - Plastic label

0824551

<https://www.phoenixcontact.com/in/products/0824551>

Plastic label, can be ordered: by sheet, yellow, labeled according to customer specifications, mounting type: adhesive, lettering field size: 15 x 5 mm

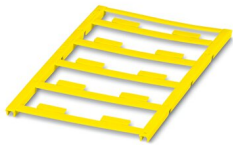

UC-EMLP (15X5) SR - Plastic label

0828095

<https://www.phoenixcontact.com/in/products/0828095>

Plastic label, Sheet, silver, unlabeled, can be labeled with: BLUEMARK ID COLOR, BLUEMARK ID, BLUEMARK CLED, PLOTMARK, CMS-P1-PLOTTER, mounting type: adhesive, lettering field size: 15 x 5 mm, Number of individual labels: 10



MINI MCR-2-U-I0 - Signal conditioner

2902022

<https://www.phoenixcontact.com/in/products/2902022>



UC-EMLP (15X5) SR CUS - Plastic label

0828099

<https://www.phoenixcontact.com/in/products/0828099>

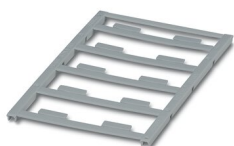

Plastic label, can be ordered: by sheet, silver, labeled according to customer specifications, mounting type: adhesive, lettering field size: 15 x 5 mm, Number of individual labels: 10

US-EMLP (15X5) - Plastic label

0828790

<https://www.phoenixcontact.com/in/products/0828790>



Plastic label, Card, white, unlabeled, can be labeled with: BLUEMARK ID COLOR, BLUEMARK ID, THERMOMARK PRIME, THERMOMARK CARD 2.0, THERMOMARK CARD, mounting type: adhesive, lettering field size: 15 x 5 mm, Number of individual labels: 189

MINI MCR-2-U-I0 - Signal conditioner



2902022

<https://www.phoenixcontact.com/in/products/2902022>

US-EMLP (15X5) YE - Plastic label

0828873

<https://www.phoenixcontact.com/in/products/0828873>



Plastic label, Card, yellow, unlabeled, can be labeled with: BLUEMARK ID COLOR, BLUEMARK ID, THERMOMARK PRIME, THERMOMARK CARD 2.0, THERMOMARK CARD, mounting type: adhesive, lettering field size: 15 x 5 mm, Number of individual labels: 189

US-EMLP (15X5) SR - Plastic label

0828874

<https://www.phoenixcontact.com/in/products/0828874>



Plastic label, Card, silver, unlabeled, can be labeled with: BLUEMARK ID COLOR, BLUEMARK ID, THERMOMARK PRIME, THERMOMARK CARD 2.0, THERMOMARK CARD, mounting type: adhesive, lettering field size: 15 x 5 mm, Number of individual labels: 189

MINI MCR-2-U-I0 - Signal conditioner

2902022

<https://www.phoenixcontact.com/in/products/2902022>

US-EMLP (15X5) CUS - Plastic label

0830076

<https://www.phoenixcontact.com/in/products/0830076>

Plastic label, can be ordered: by card, white, labeled according to customer specifications, mounting type: adhesive, lettering field size: 15 x 5 mm, Number of individual labels: 189



US-EMLP (15X5) YE CUS - Plastic label

0830077

<https://www.phoenixcontact.com/in/products/0830077>

Plastic label, can be ordered: by card, yellow, labeled according to customer specifications, mounting type: adhesive, lettering field size: 15 x 5 mm, Number of individual labels: 189



MINI MCR-2-U-I0 - Signal conditioner

2902022

<https://www.phoenixcontact.com/in/products/2902022>



US-EMLP (15X5) SR CUS - Plastic label

0830078

<https://www.phoenixcontact.com/in/products/0830078>



Plastic label, can be ordered: by card, silver, labeled according to customer specifications, mounting type: adhesive, lettering field size: 15 x 5 mm, Number of individual labels: 189

UCT-EM (30X5) YE - Marker for end clamp

0830340

<https://www.phoenixcontact.com/in/products/0830340>



Marker for end clamp, Sheet, yellow, unlabeled, can be labeled with: TOPMARK NEO, TOPMARK LASER, BLUEMARK ID COLOR, BLUEMARK ID, BLUEMARK CLED, THERMOMARK PRIME, THERMOMARK CARD 2.0, THERMOMARK CARD, mounting type: snapped, lettering field size: 30 x 5 mm, Number of individual labels: 24

MINI MCR-2-U-I0 - Signal conditioner

2902022

<https://www.phoenixcontact.com/in/products/2902022>



UCT-EM (30X5) YE CUS - Marker for end clamp

0830348

<https://www.phoenixcontact.com/in/products/0830348>

Marker for end clamp, can be ordered: by sheet, yellow, labeled according to customer specifications, mounting type: snapped into marker carrier, lettering field size: 30 x 5 mm, Number of individual labels: 24



Phoenix Contact 2023 © - all rights reserved

<https://www.phoenixcontact.com>

PHOENIX CONTACT (I) Pvt. Ltd.

A-58/2, Okhla Industrial Area, Phase - II, New Delhi-110 020

+91.1275.71420

info@phoenixcontact.co.in