

QUINT-PS/1AC/48DC/20 - Power supply unit



2866695

<https://www.phoenixcontact.com/in/products/2866695>

Please be informed that the data shown in this PDF document is generated from our Online Catalog. Please find the complete data in the user documentation. Our General Terms of Use for Downloads are valid.



Primary-switched power supply unit QUINT POWER, Screw connection, SFB Technology (Selective Fuse Breaking), input: 1-phase, output: 48 V DC / 20 A

Product Description

QUINT POWER power supplies with maximum functionality

QUINT POWER circuit breakers magnetically and therefore quickly trip at six times the nominal current, for selective and therefore cost-effective system protection. The high level of system availability is additionally ensured, thanks to preventive function monitoring, as it reports critical operating states before errors occur.

Reliable starting of heavy loads takes place via the static power reserve POWER BOOST. Thanks to the adjustable voltage, all ranges between 5 V DC ... 56 V DC are covered.

Your advantages

- Reliable starting of difficult loads
- Quick tripping of standard circuit breakers
- Preventive function monitoring

Commercial Data

Item number	2866695
Packing unit	1 pc
Minimum order quantity	1 pc
Sales Key	CMP
Product Key	CMPQ14
Catalog Page	Page 243 (C-4-2019)
GTIN	4046356547727
Weight per Piece (including packing)	3,926 g
Weight per Piece (excluding packing)	3,300 g
Customs tariff number	85044083
Country of origin	TH

Technical Data

Input data

AC operation

Nominal input voltage range	100 V AC ... 240 V AC
	120 V DC ... 300 V DC (UL 508: ≤ 250 V DC)
Input voltage range	85 V AC ... 264 V AC
	90 V DC ... 300 V DC (UL 508: ≤ 250 V DC)
Input voltage range AC	85 V AC ... 264 V AC
Input voltage range DC	90 V DC ... 300 V DC (UL 508: ≤ 250 V DC)
Electric strength, max.	300 V AC
Voltage type of supply voltage	AC/DC
Inrush current	< 15 A (typical)
Inrush current integral (I^2t)	< 1.6 A ² s
AC frequency range	45 Hz ... 65 Hz
Frequency range DC	0 Hz
Mains buffering time	typ. 20 ms (120 V AC)
	typ. 22 ms (230 V AC)
Current consumption	8.7 A (120 V AC)
	4.5 A (230 V AC)
	9.4 A (110 V DC)
	4.6 A (220 V DC)
Nominal power consumption	1046 VA
Protective circuit	Transient surge protection; Varistor
Typical response time	< 0.65 s
Input fuse	20 A (fast blow, internal)
Permissible backup fuse	B16 B25 AC:
Permissible DC backup fuse	DC: Connect a suitable fuse upstream
Recommended breaker for input protection	6 A ... 16 A (AC: Characteristics B, C, D, K)
Discharge current to PE	< 3.5 mA

Output data

Efficiency	> 93 % (for 230 V AC and nominal values)
Nominal output voltage	48 V DC ± 1 %
Setting range of the output voltage (U_{Set})	30 V DC ... 56 V DC (> 48 V DC, constant capacity restricted)
Nominal output current (I_N)	20 A (-25 °C ... 60 °C, $U_{OUT} = 48$ V DC)
POWER BOOST (I_{Boost})	22.5 A (-25 °C ... 40 °C permanent, $U_{OUT} = 48$ V DC)
Selective Fuse Breaking (I_{SFB})	100 A (12 ms)
Magnetic circuit breaker tripping	B2 / B4 / B6 / B10 / C2 / C4 / C6
Derating	60 °C ... 70 °C (2.5%/K)
Feedback voltage resistance	max. 60 V DC
Protection against overvoltage at the output (OVP)	< 60 V DC
Active current limitation	Approx. $I_{BOOST} = 22.5$ A (for short-circuit)

QUINT-PS/1AC/48DC/20 - Power supply unit



2866695

<https://www.phoenixcontact.com/in/products/2866695>

Control deviation	< 1 % (change in load, static 10 % ... 90 %)
	< 3 % (change in load, dynamic 10 % ... 90 %)
	< 0.1 % (change in input voltage ± 10 %)
Residual ripple	< 50 mV _{PP} (with nominal values)
Output power	960 W
Maximum no-load power dissipation	12 W
Power loss nominal load max.	74 W
Rise time	< 0.05 s (U_{OUT} (10 % ... 90 %))
Connection in parallel	yes, for redundancy and increased capacity
Connection in series	yes

Signal: DC OK active

Output description	$U_{OUT} > 0.9 \times U_N$: High signal
Switching voltage range	18 V DC ... 24 V DC
Maximum inrush current	≤ 20 mA (short-circuit-proof)
Continuous load current	≤ 20 mA

Signal: DC OK floating

Output description	Relay contact, $U_{OUT} > 0.9 \times U_N$: Contact closed
Maximum switching voltage	30 V AC/DC
	24 V DC
Maximum inrush current	0.5 A
	1 A
Continuous load current	≤ 1 A

Signal: POWER BOOST, active

Output description	$I_{OUT} < I_N$: High signal
Switching voltage range	18 V DC ... 24 V DC
Output voltage	+ 48 V DC
Maximum inrush current	≤ 20 mA (short-circuit-proof)
Continuous load current	≤ 20 mA

Connection data

Input

Connection method	Screw connection
Conductor cross section, rigid min.	0.2 mm ²
Conductor cross section, rigid max.	6 mm ²
Conductor cross section flexible min.	0.2 mm ²
Conductor cross section flexible max.	4 mm ²
Conductor cross section AWG min.	14
Conductor cross section AWG max.	10
Stripping length	7 mm
Screw thread	M3
Tightening torque, min	0.5 Nm
Tightening torque max	0.6 Nm

QUINT-PS/1AC/48DC/20 - Power supply unit



2866695

<https://www.phoenixcontact.com/in/products/2866695>

Output

Connection method	Screw connection
Conductor cross section, rigid min.	0.5 mm ²
Conductor cross section, rigid max.	16 mm ²
Conductor cross section flexible min.	0.5 mm ²
Conductor cross section flexible max.	16 mm ²
Conductor cross section AWG min.	8
Conductor cross section AWG max.	6
Stripping length	10 mm
Screw thread	M3
Tightening torque, min	1.2 Nm
Tightening torque max	1.5 Nm

Signal

Connection method	Screw connection
Conductor cross section, rigid min.	0.2 mm ²
Conductor cross section, rigid max.	6 mm ²
Conductor cross section flexible min.	0.2 mm ²
Conductor cross section flexible max.	4 mm ²
Conductor cross section AWG min.	24
Conductor cross section AWG max.	10
Screw thread	M3
Tightening torque, min	0.5 Nm
Tightening torque max	0.6 Nm

Signaling

Types of signaling	LED
	Active switching output
	Relay contact

Signal output: DC OK active

Status display	$U_{OUT} > 0.9 \times U_N$: "DC OK" LED green
Note on status display	$U_{OUT} < 0.9 \times U_N$: Flashing "DC OK" LED
	$I_{OUT} < I_N$: LED ON

Signal output: DC OK floating

Status display	$U_{OUT} > 0.9 \times U_N$: "DC OK" LED green
Note on status display	$U_{OUT} < 0.9 \times U_N$: Flashing "DC OK" LED

Signal output: POWER BOOST, active

Status display	$I_{OUT} > I_N$: LED "BOOST" yellow
----------------	--------------------------------------

Electrical properties

Number of phases	1.00
Insulation voltage input/output	4 kV AC (type test)

QUINT-PS/1AC/48DC/20 - Power supply unit



2866695

<https://www.phoenixcontact.com/in/products/2866695>

	2 kV AC (routine test)
Insulation voltage output / PE	500 V DC (routine test)
Insulation voltage input / PE	3.5 kV AC (type test)
	2 kV AC (routine test)

Product properties

Product type	Power supply
Product family	QUINT POWER
MTBF (IEC 61709, SN 29500)	> 880000 h (25 °C)
	> 523000 h (40 °C)

Insulation characteristics

Protection class	I
Degree of pollution	2

Dimensions

Width	180 mm
Height	130 mm
Depth	125 mm

Installation dimensions

Installation distance right/left	5 mm / 5 mm
Installation distance top/bottom	50 mm / 50 mm

Alternative assembly

Width	122 mm
Height	130 mm
Depth	183 mm

Mounting

Assembly instructions	alignable: $P_N \geq 50\%$, 5 mm horizontally, 15 mm next to active components, 50 mm vertically alignable: $P_N < 50\%$, 0 mm horizontally, 40 mm vertically top, 20 mm vertically bottom
Mounting position	horizontal DIN rail NS 35, EN 60715
With protective coating	No

Material specifications

Housing material	Metal
Type of housing	Steel sheet, zinc-plated

Environmental and real-life conditions

Ambient conditions

Degree of protection	IP20
Ambient temperature (operation)	-25 °C ... 70 °C (> 60 °C Derating: 2,5 %/K)
Ambient temperature (storage/transport)	-40 °C ... 85 °C

QUINT-PS/1AC/48DC/20 - Power supply unit



2866695

<https://www.phoenixcontact.com/in/products/2866695>

Ambient temperature (start-up type tested)	-40 °C
Maximum altitude	6000 m
Climatic class	3K3 (in acc. with EN 60721)
Max. permissible relative humidity (operation)	≤ 95 % (at 25 °C, non-condensing)
Shock	18 ms, 30g, in each space direction (according to IEC 60068-2-27)
Vibration (operation)	< 15 Hz, amplitude ±2.5 mm (according to IEC 60068-2-6) 15 Hz ... 150 Hz, 2.3g, 90 min.

Standards and regulations

Rail applications	EN 50121-4 EN 50121-3-2
Standard – Limitation of mains harmonic currents	EN 61000-3-2
Standard - Electrical safety	IEC 61010-2-201 (SELV)
Standard - Equipment safety	BG (design tested)
Standard – Protection against shock currents, basic requirements for protective separation in electrical equipment	EN 50178
Standard – Safety extra-low voltage	IEC 61010-1 (SELV) IEC 61010-2-201 (PELV)
Standard - Safe isolation	IEC 61010-2-201
Standard - safety for equipment for measurement, control, and laboratory use	IEC 61010-1

Overvoltage category

EN 62477-1	III
------------	-----

Approvals

CSA	CAN/CSA-C22.2 No. 60950-1-07 CSA-C22.2 No. 107.1-01
Shipbuilding approval	DNV GL (EMC A)
SIQ	BG (type approved)
UL approvals	UL Listed UL 508 UL/C-UL Recognized UL 60950-1 UL ANSI/ISA-12.12.01 Class I, Division 2, Groups A, B, C, D (Hazardous Location)

EMC data

Low Voltage Directive	Conformance with Low Voltage Directive 2014/35/EC
EMC requirements for noise emission	EN 61000-6-3 EN 61000-6-4
EMC requirements for noise immunity	EN 61000-6-1 EN 61000-6-2
Electromagnetic compatibility	Conformance with EMC Directive 2014/30/EU
Noise emission	EN 55011 (EN 55022)

Electrostatic discharge

QUINT-PS/1AC/48DC/20 - Power supply unit



2866695

<https://www.phoenixcontact.com/in/products/2866695>

Standards/regulations	EN 61000-4-2
Electrostatic discharge	
Contact discharge	8 kV (Test Level 4)
Discharge in air	15 kV (Test Level 4)
Comments	Criterion A
Electromagnetic HF field	
Standards/regulations	EN 61000-4-3
Electromagnetic HF field	
Frequency range	80 MHz ... 1 GHz
Test field strength	20 V/m (Test Level 3)
Frequency range	1 GHz ... 2 GHz
Test field strength	10 V/m (Test Level 3)
Frequency range	2 GHz ... 3 GHz
Test field strength	10 V/m (Test Level 3)
Comments	Criterion A
Fast transients (burst)	
Standards/regulations	EN 61000-4-4
Fast transients (burst)	
Input	4 kV (Test Level 4 - asymmetrical)
Output	2 kV (Test Level 3 - asymmetrical)
Signal	2 kV (Test Level 4 - asymmetrical)
Comments	Criterion A
Surge voltage load (surge)	
Standards/regulations	EN 61000-4-5
Input	2 kV (Test Level 3 - symmetrical)
	4 kV (Test Level 4 - asymmetrical)
Output	1 kV (Test Level 2 - symmetrical)
	2 kV (Test Level 3 - asymmetrical)
Signal	1 kV (Test Level 2 - asymmetrical)
Comments	Criterion A
Conducted interference	
Standards/regulations	EN 61000-4-6
Conducted interference	
I/O/S	asymmetrical
Frequency range	0.15 MHz ... 80 MHz
Comments	Criterion A
Voltage	10 V (Test Level 3)
Emitted interference	
Standards/regulations	EN 61000-6-3

QUINT-PS/1AC/48DC/20 - Power supply unit



2866695

<https://www.phoenixcontact.com/in/products/2866695>

Radio interference voltage in acc. with EN 55011	EN 55011 (EN 55022) Class B, area of application: Industry and residential
Emitted radio interference in acc. with EN 55011	EN 55011 (EN 55022) Class B, area of application: Industry and residential

Criteria

Criterion A	Normal operating behavior within the specified limits.
Criterion B	Temporary impairment to operational behavior that is corrected by the device itself.

QUINT-PS/1AC/48DC/20 - Power supply unit

2866695

<https://www.phoenixcontact.com/in/products/2866695>

Drawings

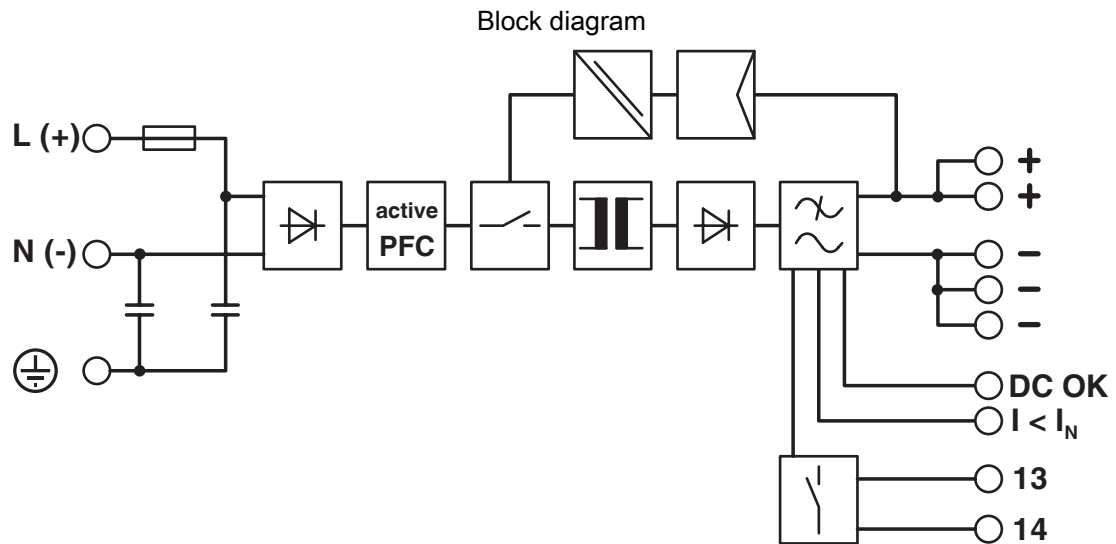

QUINT-PS/1AC/48DC/20 - Power supply unit



2866695

<https://www.phoenixcontact.com/in/products/2866695>

Approvals



UL Recognized

Approval ID: FILE E 211944



IECEE CB Scheme

Approval ID: SI-2748



EAC

Approval ID: EAC-Zulassung



EAC

Approval ID: EAC-Zulassung



UL Listed

Approval ID: FILE E 123528



EAC

Approval ID: RU S-DE.BL08.W.00764



UL Recognized

Approval ID: FILE E 211944



IECEE CB Scheme

Approval ID: SI-2748



UL Listed

Approval ID: FILE E 123528



EAC

Approval ID: RU S-DE.BL08.W.00764



EAC

Approval ID: RU S-DE.BL08.W.00764



EAC

Approval ID: RU S-DE.BL08.W.00764

QUINT-PS/1AC/48DC/20 - Power supply unit

2866695

<https://www.phoenixcontact.com/in/products/2866695>



QUINT-PS/1AC/48DC/20 - Power supply unit



2866695

<https://www.phoenixcontact.com/in/products/2866695>

Classifications

ECLASS

ECLASS-11.0	27040701
ECLASS-13.0	27040701
ECLASS-12.0	27040701

ETIM

ETIM 8.0	EC002540
----------	----------

UNSPSC

UNSPSC 21.0	39121000
-------------	----------

QUINT-PS/1AC/48DC/20 - Power supply unit



2866695

<https://www.phoenixcontact.com/in/products/2866695>

Environmental Product Compliance

REACH SVHC	Lead 7439-92-1
China RoHS	Environmentally Friendly Use Period = 25;
	For information on hazardous substances, refer to the manufacturer's declaration available under "Downloads"

QUINT-PS/1AC/48DC/20 - Power supply unit



2866695

<https://www.phoenixcontact.com/in/products/2866695>

Accessories

UTA 107 - DIN rail adapter

2853983

<https://www.phoenixcontact.com/in/products/2853983>

Universal DIN rail adapter, for screwing on switchgear



UWA 182/52 - Mounting adapter

2938235

<https://www.phoenixcontact.com/in/products/2938235>

Universal wall adapter for securely mounting the device in the event of strong vibrations. The device is screwed directly onto the mounting surface. The universal wall adapter is attached on the top/bottom.



QUINT-PS/1AC/48DC/20 - Power supply unit



2866695

<https://www.phoenixcontact.com/in/products/2866695>

UWA 130 - Mounting adapter

2901664

<https://www.phoenixcontact.com/in/products/2901664>



2-piece universal wall adapter for securely mounting the device in the event of strong vibrations. The profiles that are screwed onto the side of the device are screwed directly onto the mounting surface. The universal wall adapter is attached on the left/right.

QUINT-DIODE/48DC/2X20/1X40 - Redundancy module

2320160

<https://www.phoenixcontact.com/in/products/2320160>



DIN rail diode module 48 V DC/2x20 A or 1x40 A. Uniform redundancy up to the consumer.

QUINT-PS/1AC/48DC/20 - Power supply unit



2866695

<https://www.phoenixcontact.com/in/products/2866695>

CB TM1 1A SFB P - Thermomagnetic device circuit breaker

2800836

<https://www.phoenixcontact.com/in/products/2800836>



Thermomagnetic device circuit breaker, 1-pos., tripping characteristic SFB, 1 changeover contact, plug for base element.

CB TM1 2A SFB P - Thermomagnetic device circuit breaker

2800837

<https://www.phoenixcontact.com/in/products/2800837>



Thermomagnetic device circuit breaker, 1-pos., tripping characteristic SFB, 1 changeover contact, plug for base element.

QUINT-PS/1AC/48DC/20 - Power supply unit



2866695

<https://www.phoenixcontact.com/in/products/2866695>

CB TM1 3A SFB P - Thermomagnetic device circuit breaker

2800838

<https://www.phoenixcontact.com/in/products/2800838>



Thermomagnetic device circuit breaker, 1-pos., tripping characteristic SFB, 1 changeover contact, plug for base element.

CB TM1 4A SFB P - Thermomagnetic device circuit breaker

2800839

<https://www.phoenixcontact.com/in/products/2800839>



Thermomagnetic device circuit breaker, 1-pos., tripping characteristic SFB, 1 changeover contact, plug for base element.

QUINT-PS/1AC/48DC/20 - Power supply unit



2866695

<https://www.phoenixcontact.com/in/products/2866695>

CB TM1 5A SFB P - Thermomagnetic device circuit breaker

2800840

<https://www.phoenixcontact.com/in/products/2800840>



Thermomagnetic device circuit breaker, 1-pos., tripping characteristic SFB, 1 changeover contact, plug for base element.

CB TM1 6A SFB P - Thermomagnetic device circuit breaker

2800841

<https://www.phoenixcontact.com/in/products/2800841>



Thermomagnetic device circuit breaker, 1-pos., tripping characteristic SFB, 1 changeover contact, plug for base element.

QUINT-PS/1AC/48DC/20 - Power supply unit

2866695

<https://www.phoenixcontact.com/in/products/2866695>



CB TM1 8A SFB P - Thermomagnetic device circuit breaker

2800842

<https://www.phoenixcontact.com/in/products/2800842>



Thermomagnetic device circuit breaker, 1-pos., tripping characteristic SFB, 1 changeover contact, plug for base element.

PLT-SEC-T3-230-FM-UT - Type 3 surge protection device

2907919

<https://www.phoenixcontact.com/in/products/2907919>



Type 2/3 surge protection, consisting of protective plug and base element with screw connection. For single-phase power supply network with integrated status indicator and remote signaling. Nominal voltage: 230 V AC/DC

QUINT-PS/1AC/48DC/20 - Power supply unit

2866695

<https://www.phoenixcontact.com/in/products/2866695>



PLT-SEC-T3-60-FM-UT - Type 3 surge protection device

2907917

<https://www.phoenixcontact.com/in/products/2907917>



Type 3 surge protection, consisting of protective plug and base element, with integrated status indicator and remote signaling for single-phase power supply networks. Nominal voltage: 60 V AC/DC

Phoenix Contact 2023 © - all rights reserved

<https://www.phoenixcontact.com>

PHOENIX CONTACT (I) Pvt. Ltd.

A-58/2, Okhla Industrial Area, Phase - II, New Delhi-110 020

+91.1275.71420

info@phoenixcontact.co.in