

# MACX MCR-SL-RPSSI-I - Power/input isolating amplifier



2865955

<https://www.phoenixcontact.com/in/products/2865955>

Please be informed that the data shown in this PDF document is generated from our Online Catalog. Please find the complete data in the user documentation. Our General Terms of Use for Downloads are valid.



Repeater power supply and input signal conditioner, HART-transparent. Transmits supplied or active 0/4 ... 20 mA signals to a load (active or passive). 3-way electrical isolation, SIL 2 in accordance with IEC 61508.

## Your advantages

- Power supply possible via DIN rail connector
- Up to SIL 2 in accordance with EN 61508
- Installation in zone 2, protection type "n" (EN 60079-15) permitted
- 3-way electrical isolation
- Terminal point with 250  $\Omega$  resistor to increase HART impedance for low-resistance systems
- Plug-in screw or spring-cage connection technology (Push-in technology), with integrated sockets for HART communicators
- Bidirectional transmission of digital HART communication signals
- Output: 0/4 mA ... 20 mA (active or passive)
- Input: 0/4 mA ... 20 mA (powered or not powered)

## Commercial Data

Item number	2865955
Packing unit	1 pc
Minimum order quantity	1 pc
Sales Key	CK1
Product Key	CK1111
Catalog Page	Page 120 (C-5-2019)
GTIN	4046356448314
Weight per Piece (including packing)	173.2 g
Weight per Piece (excluding packing)	126 g
Customs tariff number	85437090
Country of origin	DE

# MACX MCR-SL-RPSSI-I - Power/input isolating amplifier



2865955

<https://www.phoenixcontact.com/in/products/2865955>

## Technical Data

### Notes

#### Utilization restriction

EMC note	EMC: class A product, see manufacturer's declaration in the download area
----------	---

### Product properties

Product type	Repeater power supplies
Product family	MACX Analog
Application	Analog IN
No. of channels	1
Type	Signal conditioners with SIL functional safety

#### Insulation characteristics: GB Standard

Overvoltage category	II
Pollution degree	2

### Electrical properties

No. of channels	1
Electrical isolation	3-way isolation
Electrical isolation between input and output	yes
Maximum power dissipation for nominal condition	0.65 W (20 mA, 250 $\Omega$ )
Signal transmission behavior	In = Out
Step response (10-90%)	< 200 $\mu$ s (for jump 4 mA ... 20 mA, load 600 $\Omega$ ) < 600 $\mu$ s (for jump 0 mA ... 20 mA, load 600 $\Omega$ )
Maximum temperature coefficient	< 0.01 %/K
Maximum transmission error	< 0.1 % (of final value)
Transmission error, typical	< 0.05 % (of final value)

#### Electrical isolation Input/output/power supply

Rated insulation voltage	300 V <sub>rms</sub>
Test voltage	2.5 kV AC (50 Hz, 60 s)
Insulation	Safe isolation in accordance with IEC/EN 61010-1

#### Electrical isolation Input/output

Electrical isolation	375 V <sub>PP</sub> (Peak value in accordance with IEC/EN 60079-11) 265 V AC/DC (Peak value in accordance with IEC/EN 60079-11)
----------------------	--

#### Electrical isolation Input/power supply

Electrical isolation	375 V <sub>PP</sub> (Peak value in accordance with IEC/EN 60079-11) 265 V AC/DC (Peak value in accordance with IEC/EN 60079-11)
----------------------	--

#### Electrical isolation Output/supply

Electrical isolation	265 V AC/DC (Peak value in accordance with IEC/EN 60079-7)
----------------------	--

# MACX MCR-SL-RPSSI-I - Power/input isolating amplifier



2865955

<https://www.phoenixcontact.com/in/products/2865955>

## Supply

Designation	Repeater power supply operation
Nominal supply voltage	24 V DC
Supply voltage range	19.2 V DC ... 30 V DC (24 V DC, -20 % ... +25 %)
Max. current consumption	< 76 mA (24 V DC / 20 mA / 1000 Ω) < 55 mA (24 V DC / 20 mA / 250 Ω)
Power dissipation	< 1.1 W (24 V DC / 20 mA / 1000 Ω) < 0.95 W (24 V DC / 20 mA / 250 Ω) < 1.2 W (24 V DC / 20 mA / 0 Ω)
Power consumption	< 1.8 W (20 mA / 1000 Ω) < 1.3 W (20 mA / 250 Ω)

## Supply

Designation	Signal conditioner operation
Nominal supply voltage	24 V DC
Supply voltage range	19.2 V DC ... 30 V DC (24 V DC, -20 % ... +25 %)
Max. current consumption	< 44 mA (24 V DC / 20 mA / 1000 Ω) < 27 mA (24 V DC / 20 mA / 250 Ω)
Power dissipation	< 0.75 W (24 V DC / 20 mA / 1000 Ω) < 0.65 W (24 V DC / 20 mA / 250 Ω) < 0.95 W (24 V DC / 20 mA / 0 Ω)

## Input data

### Signal: Repeater power supply operation

Description of the input	Active current input
Number of inputs	1
Input signal	Current
Current input signal	4 mA ... 20 mA
Current limitation	25 mA
Transmitter supply voltage	> 21.5 V (20 mA) > 20.8 V (24 mA)
Underload/overload signal range	0 mA ... 24 mA (Extended transmission range for diagnostics)

### Signal: Signal conditioner operation

Description of the input	Passive current input
Current input signal	0 mA ... 20 mA 4 mA ... 20 mA
Voltage drop	< 3.5 V (in input isolating amplifier operation)
Underload/overload signal range	0 mA ... 24 mA (Extended transmission range for diagnostics)

## Output data

### Signal: Repeater power supply operation

Output description	Current output (active and passive)
Number of outputs	1

# MACX MCR-SL-RPSSI-I - Power/input isolating amplifier



2865955

<https://www.phoenixcontact.com/in/products/2865955>

Current output signal	4 mA ... 20 mA (active)
	4 mA ... 20 mA (14 ... 26 V ext. source voltage)
Load/output load current output	< 1000 Ω (20 mA)
	< 825 Ω (24 mA)
Output ripple	< 20 mV <sub>rms</sub>
Output behavior in the event of an error	0 mA (Cable break in the input)
	≥ 22.5 mA (Cable short-circuit in the input)
Underload/overload signal range	0 mA ... 24 mA (Extended transmission range for diagnostics)

## Signal: Signal conditioner operation

Output description	Current output (active and passive)
Current output signal	0 mA ... 20 mA (active)
	4 mA ... 20 mA (active)
	0 mA ... 20 mA (14 ... 26 V ext. source voltage)
	4 mA ... 20 mA (14 ... 26 V ext. source voltage)
Load/output load current output	< 1000 Ω (20 mA)
	< 825 Ω (24 mA)
Output ripple	< 20 mV <sub>rms</sub>
Output behavior in the event of an error	0 mA (Cable break in the input)
	0 mA (Cable short-circuit in the input)
Underload/overload signal range	0 mA ... 24 mA (Extended transmission range for diagnostics)

## Connection data

Connection method	Screw connection
Stripping length	7 mm
Screw thread	M3
Conductor cross section rigid	0.2 mm <sup>2</sup> ... 2.5 mm <sup>2</sup>
Conductor cross section flexible	0.2 mm <sup>2</sup> ... 2.5 mm <sup>2</sup>
Conductor cross section AWG	24 ... 14
Tightening torque	0.5 Nm ... 0.6 Nm

## Test socket

Max. diameter	2 mm
---------------	------

## Ex data

Ex installation (EPL)	Gc
	Div. 2

## Interfaces

### Data communication (bypass)

HART function	Yes
Protocols supported	HART-transparent

## Signaling

Status display	Green LED (supply voltage)
----------------	----------------------------

# MACX MCR-SL-RPSSI-I - Power/input isolating amplifier



2865955

<https://www.phoenixcontact.com/in/products/2865955>

## Dimensions

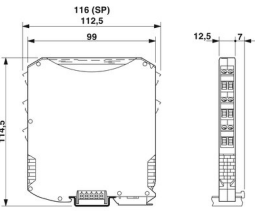
Dimensional drawing	
Width	12.5 mm
Height	112.5 mm
Depth	113.7 mm
Depth NS 35/7,5	114.5 mm (Snapped onto DIN rail NS 35/7,5 in accordance with EN 60715)

## Material specifications

Flammability rating according to UL 94	V0 (Housing)
Housing material	PA 6.6-FR

## Environmental and real-life conditions

### Ambient conditions

Degree of protection	IP20 (not assessed by UL)
Ambient temperature (operation)	-20 °C ... 60 °C (Any mounting position)
Ambient temperature (storage/transport)	-40 °C ... 80 °C
Permissible humidity (operation)	10 % ... 95 % (non-condensing)

### Altitude range (≤ 2000 m)

Altitude	≤ 2000 m (The technical data refers to altitudes ≤2000 m above mean sea level. For altitudes >2000 m above mean sea level, refer to the data sheet.)
Ambient temperature (operation)	-20 °C ... 60 °C
Rated insulation voltage	375 V <sub>PP</sub> (Power supply, input / output)

### Altitude range (≤ 3000 m)

Height range	> 2000 m ... 3000 m
Ambient temperature (operation)	-20 °C ... 54 °C
Rated insulation voltage	190 V AC (Power supply, input / output) 110 V DC (Power supply, input / output)

### Altitude range (≤ 4000 m)

Height range	> 3000 m ... 4000 m
Ambient temperature (operation)	-20 °C ... 48 °C
Rated insulation voltage	60 V AC/DC (Power supply, input / output)

### Altitude range (≤ 5000 m)

Height range	> 4000 m ... 5000 m
Ambient temperature (operation)	-20 °C ... 42 °C

# MACX MCR-SL-RPSSI-I - Power/input isolating amplifier



2865955

<https://www.phoenixcontact.com/in/products/2865955>

Rated insulation voltage	60 V AC/DC (Power supply, input / output)
--------------------------	---

## Approvals

### CE

Certificate	CE-compliant
Note	and EN 61326

### ATEX

Identification	<input type="checkbox"/> II 3 G Ex ec IIC T4 Gc
Certificate	PxCIF08ATEX2865955X

### UKCA Ex (UKEX)

Identification	<input type="checkbox"/> II 3 G Ex nA IIC T4 Gc X
Certificate	PxCIF21UKEX2865955X

### IECEX

Identification	Ex ec IIC T4 Gc
Certificate	IECEX BVS 08.0016X

### CCC / China-Ex

Identification	Ex ec IIC T4 Gc
Certificate	2022122304115127

### UL, USA/Canada

Identification	UL 61010 Listed
	UL 508 Listed
	Class I, Div. 2, Groups A, B, C, D T4
	Class I, Zone 2, Group IIC T4

### Shipbuilding approval

Certificate	DNV GL TAA000020C
-------------	-------------------

### Safety Integrity Level (SIL, IEC 61508)

Identification	2
Certificate	BVS PB 03/08-2

### INMETRO

Identification	Ex ec IIC T4 Gc
Certificate	DNV 18.0136 X

### EAC Ex

Identification	<input type="checkbox"/> 2Ex nA IIC T4 Gc
Certificate	BY/112 02.01 TP012 103.01 00078

### DNV GL data

Temperature	B
Humidity	B
Vibration	A

# MACX MCR-SL-RPSSI-I - Power/input isolating amplifier



2865955

<https://www.phoenixcontact.com/in/products/2865955>

EMC	A
Enclosure	Required protection according to the Rules shall be provided upon installation on board

## EMC data

Noise immunity	EN 61000-6-2
Note	When being exposed to interference, there may be minimal deviations.
Electromagnetic compatibility	Conformance with EMC directive
Noise emission	EN 61000-6-4

## Standards and regulations

Electrical isolation	3-way isolation
----------------------	-----------------

### GB Standard

Standards/regulations	GB 3836.1
	GB 3836.3

## Mounting

Mounting type	DIN rail mounting
---------------	-------------------

# MACX MCR-SL-RPSSI-I - Power/input isolating amplifier

2865955

<https://www.phoenixcontact.com/in/products/2865955>

## Drawings

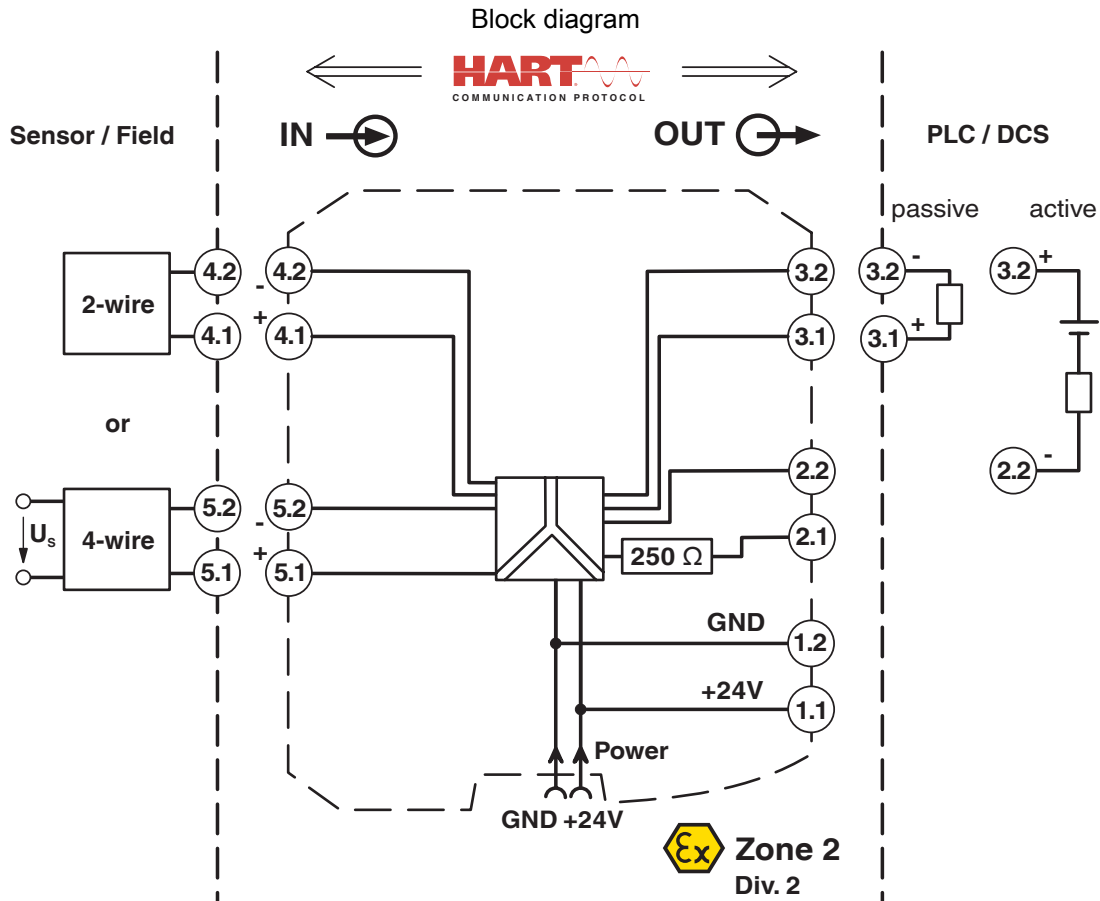



# MACX MCR-SL-RPSSI-I - Power/input isolating amplifier

2865955

<https://www.phoenixcontact.com/in/products/2865955>

Dimensional drawing

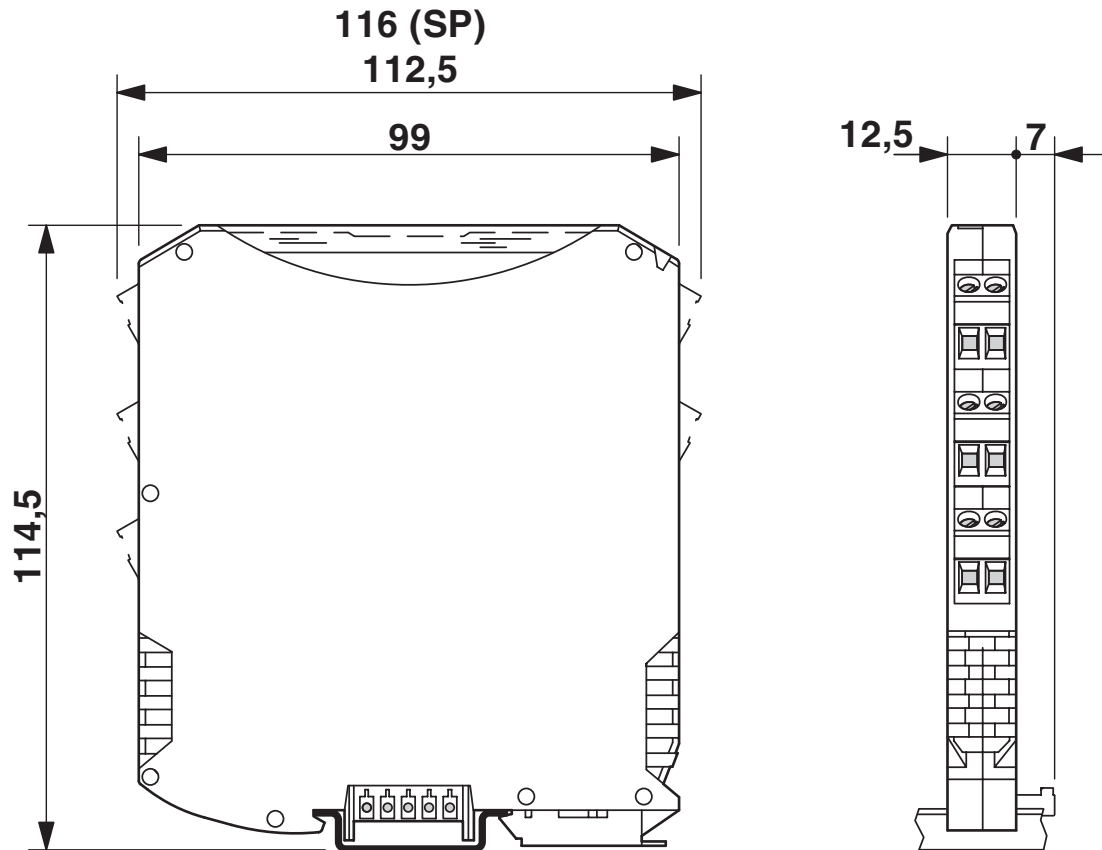

Diagram

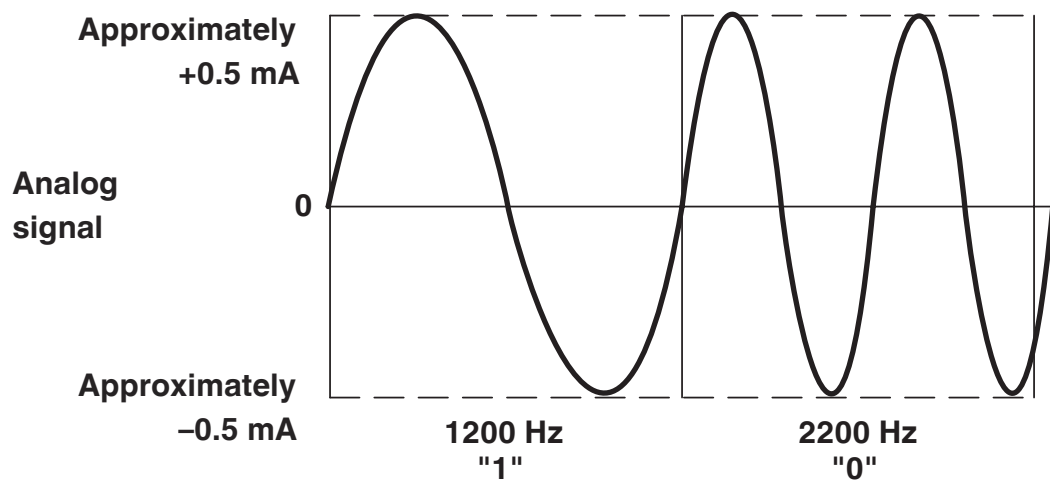

Signal transmission analog and digital at the same time

# MACX MCR-SL-RPSSI-I - Power/input isolating amplifier



2865955

<https://www.phoenixcontact.com/in/products/2865955>

## Approvals



**DNV GL**

Approval ID: TAA000020C



**UL Listed**

Approval ID: FILE E 330267



**cUL Listed**

Approval ID: FILE E 330267



**CCC**

Approval ID: 2022122304115127



**EAC Ex**

Approval ID: TP012 103.01 00078



**ATEX**

Approval ID: PxCIF08ATEX2865955X



**cUL Listed**

Approval ID: FILE E 199827



**UL Listed**

Approval ID: FILE E 199827

# MACX MCR-SL-RPSSI-I - Power/input isolating amplifier



2865955

<https://www.phoenixcontact.com/in/products/2865955>

## Classifications

### ECLASS

ECLASS-11.0	27210120
ECLASS-12.0	27210120
ECLASS-13.0	27210120

### ETIM

ETIM 8.0	EC002653
----------	----------

### UNSPSC

UNSPSC 21.0	39121000
-------------	----------

# MACX MCR-SL-RPSSI-I - Power/input isolating amplifier



2865955

<https://www.phoenixcontact.com/in/products/2865955>

## Environmental Product Compliance

REACH SVHC	Lead 7439-92-1
China RoHS	Environmentally Friendly Use Period = 50 years
	For information on hazardous substances, refer to the manufacturer's declaration available under "Downloads"

# MACX MCR-SL-RPSSI-I - Power/input isolating amplifier



2865955

<https://www.phoenixcontact.com/in/products/2865955>

## Accessories

ME 6,2 TBUS-2 1,5/5-ST-3,81 GY - DIN rail bus connectors

2695439

<https://www.phoenixcontact.com/in/products/2695439>

DIN rail connector (TBUS), 5-pos., for bridging the supply voltage, can be snapped onto NS 35/... DIN rail in accordance with EN 60715

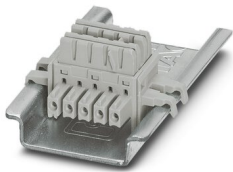

---

GW HART USB MODEM - Cable adapter

1003824

<https://www.phoenixcontact.com/in/products/1003824>

USB HART modem cable for communication between a PC and HART devices, cable length: 1m.



# MACX MCR-SL-RPSSI-I - Power/input isolating amplifier

2865955

<https://www.phoenixcontact.com/in/products/2865955>

## TC-D37SUB-ADIO16-EX-P-UNI - Module carrier

2924854

<https://www.phoenixcontact.com/in/products/2924854>



Universal termination carrier for connecting 16 MACX Analog Ex i signal conditioners to digital or analog I/O cards, via D-SUB connector, 37-pos. (1:1 connection)

---

## TC-D37SUB-AIO16-EX-PS-UNI - Module carrier

2902932

<https://www.phoenixcontact.com/in/products/2902932>



Universal termination carrier for connecting 16 MACX Analog Ex i signal conditioners to digital or analog I/O cards, via D-SUB connector, 37-pos. (1:1 connection), with HART multiplexer connection

# MACX MCR-SL-RPSSI-I - Power/input isolating amplifier

2865955

<https://www.phoenixcontact.com/in/products/2865955>

## MACX MCR-PTB - Power and error message module

2865625

<https://www.phoenixcontact.com/in/products/2865625>



Power and fault signaling module with screw connection, including corresponding ME 17,5 TBUS 1,5/ 5-ST-3,81 GY DIN rail connector

---

## MACX MCR-PTB-SP - Power and error message module

2924184

<https://www.phoenixcontact.com/in/products/2924184>



Power and fault signaling module with Push-in connection, including corresponding ME 17,5 TBUS 1,5/ 5-ST-3,81 GY DIN rail connector

# MACX MCR-SL-RPSSI-I - Power/input isolating amplifier

2865955

<https://www.phoenixcontact.com/in/products/2865955>

## QUINT4-SYS-PS/1AC/24DC/2.5/SC - Power supply unit

2904614

<https://www.phoenixcontact.com/in/products/2904614>



Primary-switched power supply, QUINT POWER, screw connection, DIN rail mounting, supply of devices possible via the TBUS DIN rail connector, protective coating, input: single-phase, output: 24 V DC/2.5 A

---

## MPS-IH WH - Insulating sleeve

0201663

<https://www.phoenixcontact.com/in/products/0201663>

Insulating sleeve, color: white





# MACX MCR-SL-RPSSI-I - Power/input isolating amplifier

2865955

<https://www.phoenixcontact.com/in/products/2865955>

## MPS-IH RD - Insulating sleeve

0201676

<https://www.phoenixcontact.com/in/products/0201676>

Insulating sleeve, color: red



---

## MPS-IH BU - Insulating sleeve

0201689

<https://www.phoenixcontact.com/in/products/0201689>

Insulating sleeve, color: blue

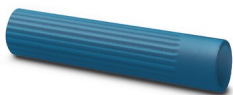

# MACX MCR-SL-RPSSI-I - Power/input isolating amplifier

2865955

<https://www.phoenixcontact.com/in/products/2865955>

## MPS-IH YE - Insulating sleeve

0201692

<https://www.phoenixcontact.com/in/products/0201692>

Insulating sleeve, color: yellow



---

## MPS-IH GN - Insulating sleeve

0201702

<https://www.phoenixcontact.com/in/products/0201702>

Insulating sleeve, color: green



# MACX MCR-SL-RPSSI-I - Power/input isolating amplifier

2865955

<https://www.phoenixcontact.com/in/products/2865955>

## MPS-IH GY - Insulating sleeve

0201728

<https://www.phoenixcontact.com/in/products/0201728>

Insulating sleeve, color: gray



## MPS-IH BK - Insulating sleeve

0201731

<https://www.phoenixcontact.com/in/products/0201731>

Insulating sleeve, color: black



# MACX MCR-SL-RPSSI-I - Power/input isolating amplifier



2865955

<https://www.phoenixcontact.com/in/products/2865955>

## MPS-MT - Test plugs

0201744

<https://www.phoenixcontact.com/in/products/0201744>



Test plugs, with solder connection up to 1 mm<sup>2</sup> conductor cross section, number of positions: 1, color: gray

---

## UC-EMLP (11X9) - Plastic label

0819291

<https://www.phoenixcontact.com/in/products/0819291>



Plastic label, Sheet, white, unlabeled, can be labeled with: BLUEMARK ID COLOR, BLUEMARK ID, BLUEMARK CLED, PLOTMARK, CMS-P1-PLOTTER, mounting type: adhesive, lettering field size: 11 x 9 mm, Number of individual labels: 10

# MACX MCR-SL-RPSSI-I - Power/input isolating amplifier



2865955

<https://www.phoenixcontact.com/in/products/2865955>

## UC-EMLP (11X9) YE - Plastic label

0822602

<https://www.phoenixcontact.com/in/products/0822602>

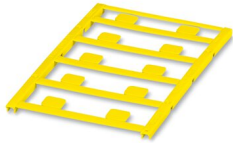

Plastic label, Sheet, yellow, unlabeled, can be labeled with: BLUEMARK ID COLOR, BLUEMARK ID, BLUEMARK CLED, PLOTMARK, CMS-P1-PLOTTER, mounting type: adhesive, lettering field size: 11 x 9 mm, Number of individual labels: 10

---

## UC-EMLP (11X9) CUS - Plastic label

0824547

<https://www.phoenixcontact.com/in/products/0824547>



Plastic label, can be ordered: by sheet, white, labeled according to customer specifications, mounting type: adhesive, lettering field size: 11 x 9 mm

# MACX MCR-SL-RPSSI-I - Power/input isolating amplifier



2865955

<https://www.phoenixcontact.com/in/products/2865955>

## UC-EMLP (11X9) YE CUS - Plastic label

0824548

<https://www.phoenixcontact.com/in/products/0824548>

Plastic label, can be ordered: by sheet, yellow, labeled according to customer specifications, mounting type: adhesive, lettering field size: 11 x 9 mm

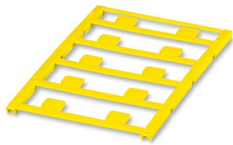

---

## UC-EMLP (11X9) SR - Plastic label

0828094

<https://www.phoenixcontact.com/in/products/0828094>

Plastic label, Sheet, silver, unlabeled, can be labeled with: BLUEMARK ID COLOR, BLUEMARK ID, BLUEMARK CLED, PLOTMARK, CMS-P1-PLOTTER, mounting type: adhesive, lettering field size: 11 x 9 mm, Number of individual labels: 10



# MACX MCR-SL-RPSSI-I - Power/input isolating amplifier

2865955

<https://www.phoenixcontact.com/in/products/2865955>

## UC-EMLP (11X9) SR CUS - Plastic label

0828098

<https://www.phoenixcontact.com/in/products/0828098>

Plastic label, can be ordered: by sheet, silver, labeled according to customer specifications, mounting type: adhesive, lettering field size: 11 x 9 mm, Number of individual labels: 10



---

## US-EMLP (11X9) - Plastic label

0828789

<https://www.phoenixcontact.com/in/products/0828789>

Plastic label, Card, white, unlabeled, can be labeled with: BLUEMARK ID COLOR, BLUEMARK ID, THERMOMARK PRIME, THERMOMARK CARD 2.0, THERMOMARK CARD, mounting type: adhesive, lettering field size: 11 x 9 mm, Number of individual labels: 135



# MACX MCR-SL-RPSSI-I - Power/input isolating amplifier



2865955

<https://www.phoenixcontact.com/in/products/2865955>

## US-EMLP (11X9) YE - Plastic label

0828871

<https://www.phoenixcontact.com/in/products/0828871>



Plastic label, Card, yellow, unlabeled, can be labeled with: BLUEMARK ID COLOR, BLUEMARK ID, THERMOMARK PRIME, THERMOMARK CARD 2.0, THERMOMARK CARD, mounting type: adhesive, lettering field size: 11 x 9 mm, Number of individual labels: 135

---

## US-EMLP (11X9) SR - Plastic label

0828872

<https://www.phoenixcontact.com/in/products/0828872>



Plastic label, Card, silver, unlabeled, can be labeled with: BLUEMARK ID COLOR, BLUEMARK ID, THERMOMARK PRIME, THERMOMARK CARD 2.0, THERMOMARK CARD, mounting type: adhesive, lettering field size: 11 x 9 mm, Number of individual labels: 135



# MACX MCR-SL-RPSSI-I - Power/input isolating amplifier



2865955

<https://www.phoenixcontact.com/in/products/2865955>

## LS-EMLP (11X9) WH - Device marker

0831678

<https://www.phoenixcontact.com/in/products/0831678>

Device marker, Sheet, white, unlabeled, can be labeled with: TOPMARK NEO, TOPMARK LASER: without print, mounting type: adhesive, lettering field size: 11 x 9 mm, Number of individual labels: 255



---

## LS-EMLP (11X9) SR - Device marker

0831705

<https://www.phoenixcontact.com/in/products/0831705>

Device marker, Sheet, silver, unlabeled, can be labeled with: TOPMARK NEO, TOPMARK LASER: without print, mounting type: adhesive, lettering field size: 11 x 9 mm, Number of individual labels: 255



# MACX MCR-SL-RPSSI-I - Power/input isolating amplifier



2865955

<https://www.phoenixcontact.com/in/products/2865955>

## LS-EMLP (11X9) YE - Device marker

0831732

<https://www.phoenixcontact.com/in/products/0831732>

Device marker, Sheet, yellow, unlabeled, can be labeled with: TOPMARK NEO, TOPMARK LASER: without print, mounting type: adhesive, lettering field size: 11 x 9 mm, Number of individual labels: 255

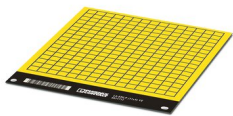

---

Phoenix Contact 2023 © - all rights reserved

<https://www.phoenixcontact.com>

PHOENIX CONTACT (I) Pvt. Ltd.

A-58/2, Okhla Industrial Area, Phase - II, New Delhi-110 020

+91.1275.71420

[info@phoenixcontact.co.in](mailto:info@phoenixcontact.co.in)