

PT 2X2-24DC-ST - Surge protection plug



2838228

<https://www.phoenixcontact.com/in/products/2838228>

Please be informed that the data shown in this PDF document is generated from our Online Catalog. Please find the complete data in the user documentation. Our General Terms of Use for Downloads are valid.



PT protective connector with protective circuit for two 2-wire floating signal circuits. 24 V DC nominal voltage. HART-compatible.

Your advantages

- Easy testing and documentation with CHECKMASTER 2 with pluggable protective modules
- Maximum ease of maintenance, thanks to the 2-piece design
- Easy selection for all possible demands in MCR applications with a complete product portfolio
- The signal is not influenced during maintenance work, thanks to the impedance-neutral insertion and removal of protective plugs

Commercial Data

Item number	2838228
Packing unit	10 pc
Minimum order quantity	1 pc
Sales Key	CL2
Product Key	CL2111
Catalog Page	Page 123 (C-4-2019)
GTIN	4017918182649
Weight per Piece (including packing)	25.54 g
Weight per Piece (excluding packing)	21.29 g
Customs tariff number	85363010
Country of origin	DE

PT 2X2-24DC-ST - Surge protection plug



2838228

<https://www.phoenixcontact.com/in/products/2838228>

Technical Data

Notes

General

Note	Technical data is valid in association with the following specified base elements:
	PT 2X2+F-BE 2839224
	PT 2X2-BE 2839208

Product properties

IEC test classification	C1
	C2
	C3
	D1
Type	Male
Product type	Surge protection for MCR technology
Product family	PLUGTRAB PT
Surge protection fault message	none
Arrester can be tested with CHECKMASTER from software version:	From SW rev. 1.00
Wire pairs per module	2

Insulation characteristics

Overvoltage category	III
Pollution degree	2

Electrical properties

Nominal voltage U_N	24 V DC
-----------------------	---------

Connection data

Connection method	Screw connection (in connection with the base element)
Screw thread	M3
Tightening torque	0.5 Nm
Conductor cross section flexible	0.2 mm ² ... 2.5 mm ²
Conductor cross section rigid	0.2 mm ² ... 4 mm ²
Conductor cross section AWG	24 ... 12

Dimensions

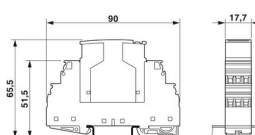
Dimensional drawing	
Width	17.5 mm

PT 2X2-24DC-ST - Surge protection plug



2838228

<https://www.phoenixcontact.com/in/products/2838228>

Height	44.8 mm
Depth	51.7 mm
Horizontal pitch	1 Div.
Complete module width	17.7 mm
Complete module height	90 mm
Complete module depth	65.5 mm

Material specifications

Color	jet black RAL 9005
Flammability rating according to UL 94	V-0
Housing material	PA 6.6

Mechanical properties

Mechanical data

Open side panel	No
-----------------	----

Protective circuit

Direction of action	Line-Line & Line-Signal Ground/Shield & optional Signal Ground/Shield-Earth Ground
Maximum continuous voltage U_C	28 V DC
	20 V AC
Rated current	450 mA (45 °C)
Operating effective current I_C at U_C	$\leq 5 \mu\text{A}$
Residual current I_{PE}	$\leq 1 \mu\text{A}$ (with PT 2X2+F-BE)
	$\leq 4 \mu\text{A}$ (with PT 2X2-BE)
Nominal discharge current I_n (8/20) μs (line-line)	10 kA
Nominal discharge surge current I_n (8/20) μs (Core-Earth)	10 kA
Pulse discharge current I_{imp} (10/350) μs	2.5 kA
Total discharge current I_{total} (8/20) μs	20 kA
Max. discharge current I_{max} (8/20) μs maximum (line-line)	10 kA
Max. discharge current I_{max} (8/20) μs maximum (line-earth)	10 kA
Nominal pulse current I_{an} (10/1000) μs (line-line)	25 A
Output voltage limitation at 1 kV/ μs (line-line) spike	$\leq 45 \text{ V}$
Output voltage limitation at 1 kV/ μs (line-earth) spike	$\leq 450 \text{ V}$ (with PT 2X2-BE)
	$\leq 1 \text{ kV}$ (with PT 2X2+F-BE)
Output voltage limitation at 1 kV/ μs (line-line) static	$\leq 40 \text{ V}$
Output voltage limitation at 1 kV/ μs (line-earth) static	$\leq 25 \text{ V}$ (with PT 2X2-BE)
	$\leq 50 \text{ V}$ (with PT 2X2+F-BE)
Residual voltage at I_n (conductor-conductor)	$\leq 40 \text{ V}$
Residual voltage at I_n (line-signalground)	$\leq 450 \text{ V}$
Residual voltage with I_{an} (10/1000) μs (line-line)	$\leq 50 \text{ V}$
Voltage protection level U_p (line-line)	$\leq 70 \text{ V}$ (C1 - 1 kV / 500 A)
	$\leq 60 \text{ V}$ (C2 - 6 kV / 3 kA)
	$\leq 70 \text{ V}$ (C2 - 10 kV / 5 kA)

PT 2X2-24DC-ST - Surge protection plug



2838228

<https://www.phoenixcontact.com/in/products/2838228>

	≤ 50 V (C3 - 25 A)
Voltage protection level U_p (line-earth)	≤ 450 V (C1 - 1 kV / 500 A with PT 2X2-BE)
	≤ 500 V (C2 - 6 kV / 3 kA with PT 2X2-BE)
	≤ 550 V (C2 - 10 kV / 5 kA with PT 2X2-BE)
	≤ 1000 V (C2 - 10 kV / 5 kA with PT 2X2+F-BE)
Voltage protection level U_p static (line-line)	≤ 40 V (C2 - 10 kV / 5 kA)
Voltage protection level U_p static (line-earth)	≤ 50 V (C2 - 10 kV / 5 kA with PT 2X2-BE)
	≤ 100 V (C2 - 10 kV / 5 kA with PT 2X2+F-BE)
Response time t_A (line-line)	≤ 1 ns
Response time t_A (line-earth)	≤ 100 ns
Input attenuation aE, sym.	typ. 0.5 dB (≤ 1 MHz / 50 Ω)
	typ. 0.3 dB (≤ 400 kHz / 150 Ω)
	typ. 0.1 dB (≤ 70 kHz / 600 Ω)
Cut-off frequency f_g (3 dB), sym. in 50 Ω system	typ. 4.5 MHz
Cut-off frequency f_g (3 dB), sym. in 150 Ω system	typ. 1.5 MHz
Cut-off frequency f_g (3 dB), sym. in 600 Ω system	typ. 600 kHz
Capacity (Core-Core)	typ. 1.4 nF
Capacity (Core-Earth)	typ. 8 pF (with PT 2X2-BE)
	typ. 2 pF (with PT 2X2+F-BE)
Resistance per path	2.2 Ω ±10 %
Surge protection fault message	none
Max. required back-up fuse	500 mA (T)
Impulse durability (line-line)	C1 - 1 kV / 500 A
	C2 - 6 kV / 3 kA
	C2 - 10 kV / 5 kA
	C3 - 25 A
Impulse durability (line-earth)	C1 - 1 kV / 500 A
	C2 - 6 kV / 3 kA
	C2 - 10 kV / 5 kA
	D1 - 2.5 kA

Environmental and real-life conditions

Ambient conditions

Degree of protection	IP20
Ambient temperature (operation)	-40 °C ... 85 °C
Ambient temperature (storage/transport)	-40 °C ... 85 °C
Altitude	≤ 2000 m (amsl (above mean sea level))

Standards and regulations

Standards/specifications	IEC 61643-21
Standards/specifications	EN 61643-21

Mounting

Mounting type	on base element
---------------	-----------------

Drawings

Diagram

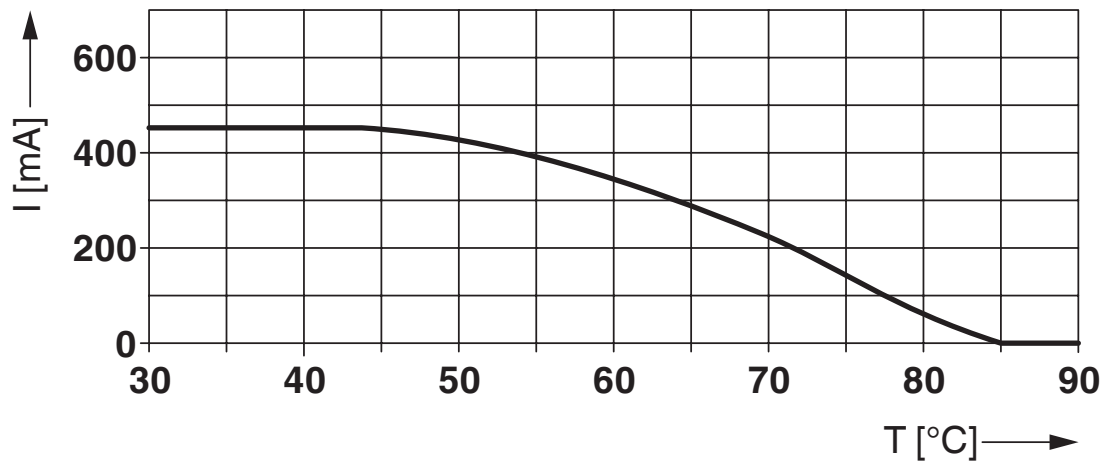

Dimensional drawing

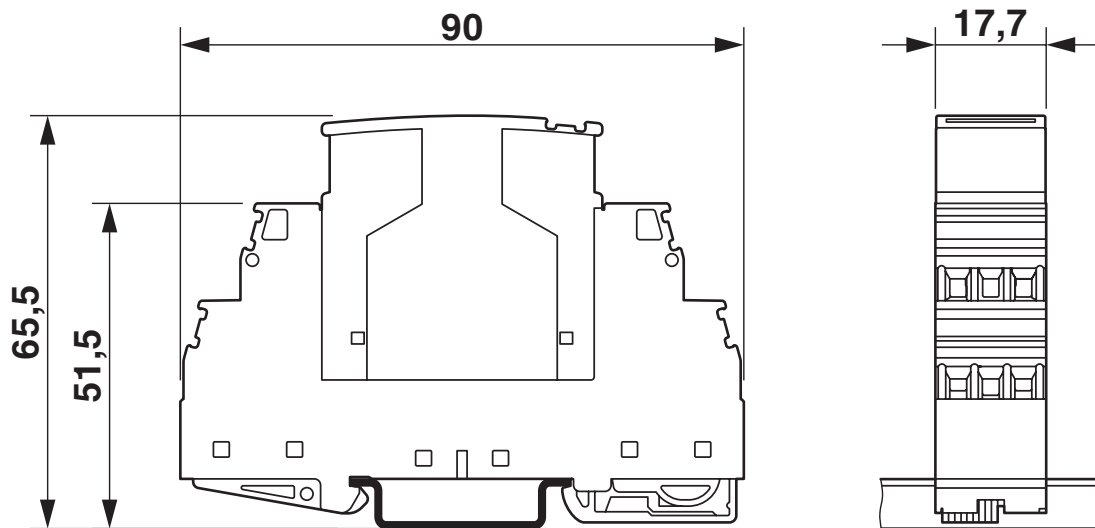

The figure shows the complete module consisting of a base element and connector

PT 2X2-24DC-ST - Surge protection plug

2838228

<https://www.phoenixcontact.com/in/products/2838228>



Circuit diagram

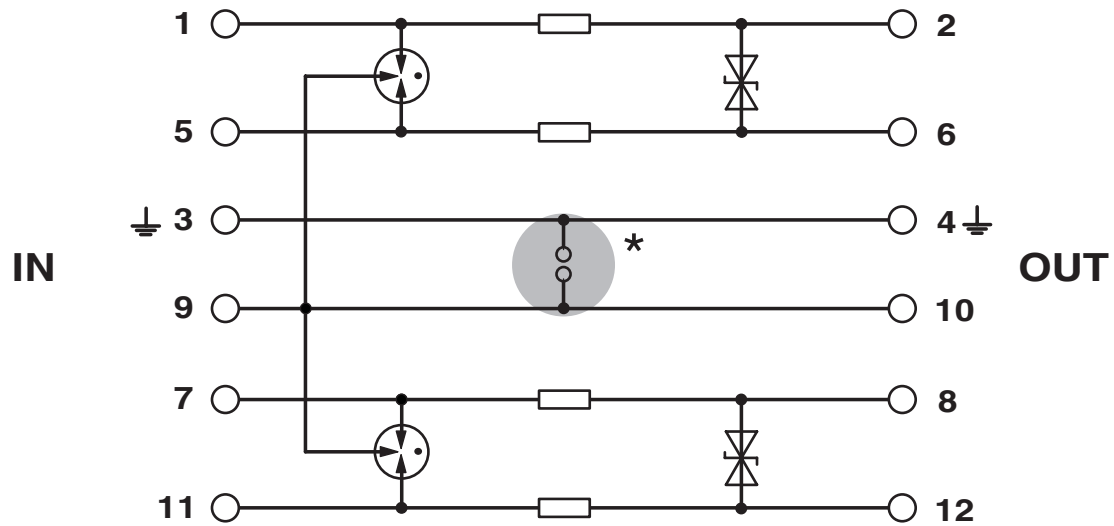

PT 2X2-24DC-ST - Surge protection plug



2838228

<https://www.phoenixcontact.com/in/products/2838228>

Approvals



EAC

Approval ID: EAC-Zulassung



DNV GL

Approval ID: TAE00001N6



EAC

Approval ID: RU C-DE.*09.B.00169



UL Listed

Approval ID: FILE E 138168

Nominal Voltage U_N	Nominal Current I_N	Cross Section AWG	Cross Section mm^2
24 V	0.45 A	-	-



cUL Listed

Approval ID: FILE E 333250



UL Listed

Approval ID: FILE E 333250



ATEX

Approval ID: 2856113_Ex-n

PT 2X2-24DC-ST - Surge protection plug



2838228

<https://www.phoenixcontact.com/in/products/2838228>

Classifications

ECLASS

ECLASS-11.0

27130807

ETIM

ETIM 8.0

EC000943

UNSPSC

UNSPSC 21.0

39121600

PT 2X2-24DC-ST - Surge protection plug



2838228

<https://www.phoenixcontact.com/in/products/2838228>

Environmental Product Compliance

REACH SVHC	Lead 7439-92-1
China RoHS	Environmentally Friendly Use Period = 50 years
	For information on hazardous substances, refer to the manufacturer's declaration available under "Downloads"

PT 2X2-24DC-ST - Surge protection plug



2838228

<https://www.phoenixcontact.com/in/products/2838228>

Mandatory Accessories

PT 2X2-BE - Surge protection base-element

2839208

<https://www.phoenixcontact.com/in/products/2839208>

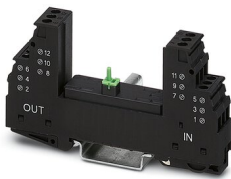

Base element for protective plug PT with protective circuit for two 2-wire floating signal circuit, bridge between the connections 3-4 (GND) and 9-10, for mounting on NS 35/7.5 and NS 35/15, housing width: 17.5 mm

PT 2X2+F-BE - Surge protection base-element

2839224

<https://www.phoenixcontact.com/in/products/2839224>

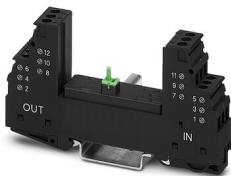

Base element for protective plug PT with protective circuit for two 2-wire floating signal circuit, gas-filled surge arrester between the connections 3-4 (GND) and 9-10, for mounting on NS 35/7.5 and NS 35/15, housing width: 17.5 mm

Accessories

PT 2X2-24DC-ST - Surge protection plug

2838228

<https://www.phoenixcontact.com/in/products/2838228>



X-PEN 0,35 - Marker pen

0811228

<https://www.phoenixcontact.com/in/products/0811228>



Marker pen without ink cartridge, for manual labeling of markers, labeling extremely wipe-proof, line thickness 0.35 mm

ZBF 5:UNBEDRUCKT - Zack Marker strip, flat

0808642

<https://www.phoenixcontact.com/in/products/0808642>



Zack Marker strip, flat, Strip, white, unlabeled, can be labeled with: PLOTMARK, CMS-P1-PLOTTER, mounting type: snapped, for terminal block width: 5 mm, lettering field size: 5.1 x 5.2 mm, Number of individual labels: 10

PT 2X2-24DC-ST - Surge protection plug

2838228

<https://www.phoenixcontact.com/in/products/2838228>

ZBF 5/WH-100:UNBEDRUCKT - Zack Marker strip, flat

0808668

<https://www.phoenixcontact.com/in/products/0808668>



Zack Marker strip, flat, Strip, white, unlabeled, can be labeled with: CMS-P1-PLOTTER, PLOTMARK, mounting type: snapped, for terminal block width: 5 mm, lettering field size: 5.15 x 5.15 mm, Number of individual labels: 1000

ZBF 5,LGS:FORTL.ZAHLEN - Zack Marker strip, flat

0808671

<https://www.phoenixcontact.com/in/products/0808671>



Zack Marker strip, flat, Strip, white, labeled, printed horizontally: consecutive numbers 1 ... 10, 11 ... 20, etc. up to 491 ... 500, mounting type: snapped, for terminal block width: 5 mm, lettering field size: 5.15 x 5.15 mm, Number of individual labels: 10

PT 2X2-24DC-ST - Surge protection plug

2838228

<https://www.phoenixcontact.com/in/products/2838228>

ZBF 5,LGS:GERADE ZAHLEN - Zack Marker strip, flat

0810821

<https://www.phoenixcontact.com/in/products/0810821>



Zack Marker strip, flat, Strip, white, labeled, printed horizontally: consecutive even numbers 2 ... 20, 22 ... 40, etc. up to 82 ... 100, mounting type: snapped, for terminal block width: 5 mm, lettering field size: 5.15 x 5.15 mm, Number of individual labels: 10

ZBF 5,LGS:UNGERADE ZAHLEN - Zack Marker strip, flat

0810863

<https://www.phoenixcontact.com/in/products/0810863>



Zack Marker strip, flat, Strip, white, labeled, printed horizontally: Odd numbers 1 - 19, 21 - 39, etc. up to 81 - 99, mounting type: snapped, for terminal block width: 5 mm, lettering field size: 5.15 x 5.15 mm, Number of individual labels: 10

PT 2X2-24DC-ST - Surge protection plug

2838228

<https://www.phoenixcontact.com/in/products/2838228>

ZBF 5,QR:FORTL.ZAHLEN - Zack Marker strip, flat

0808697

<https://www.phoenixcontact.com/in/products/0808697>

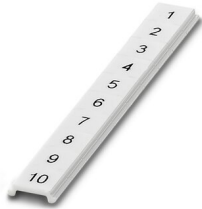

Zack Marker strip, flat, Strip, white, labeled, Printed vertically: consecutive numbers 1 ... 10, 11 ... 20, etc. up to 91 ... 100, mounting type: snapped, for terminal block width: 5 mm, lettering field size: 5.15 x 5.15 mm, Number of individual labels: 10

ZBN 18:UNBEDRUCKT - Zack marker strip

2809128

<https://www.phoenixcontact.com/in/products/2809128>



Zack marker strip, Strip, white, unlabeled, can be labeled with: CMS-P1-PLOTTER, PLOTMARK, mounting type: snapped, for terminal block width: 18 mm, lettering field size: 18 x 5 mm, Number of individual labels: 5

PT 2X2-24DC-ST - Surge protection plug

2838228

<https://www.phoenixcontact.com/in/products/2838228>



SSA 3-6 - Shield connection

2839295

<https://www.phoenixcontact.com/in/products/2839295>

Shield fast connection for 3 ... 6 mm cable diameter. Potential connecting cable:
200 mm, 1 mm², color: black



SSA 5-10 - Shield connection

2839512

<https://www.phoenixcontact.com/in/products/2839512>

Shield fast connection for 5 ... 10 mm cable diameter. Potential connecting cable:
200 mm, 1 mm², color: black



Phoenix Contact 2023 © - all rights reserved
<https://www.phoenixcontact.com>

PHOENIX CONTACT (I) Pvt. Ltd.
A-58/2, Okhla Industrial Area, Phase - II, New Delhi-110 020

+91.1275.71420
info@phoenixcontact.co.in