

VAL-MS BE - Type 2 surge protection base element



2817741

<https://www.phoenixcontact.com/in/products/2817741>

Please be informed that the data shown in this PDF document is generated from our Online Catalog. Please find the complete data in the user documentation. Our General Terms of Use for Downloads are valid.

Base element for type 2 arresters of the VALVETRAB MS series of products. Design: 1-channel



Your advantages

- Quality proven millions of times over in the widest range of applications
- Rapid installation with bridges, thanks to industry-standard overall width of 1 HP
- Easy testing and insulation measurement, thanks to pluggable protection modules
- Wide range of applications due to various nominal voltages
- High degree of modularity provides individual solutions for every application

Commercial Data

Item number	2817741
Packing unit	10 pc
Minimum order quantity	10 pc
Sales Key	CL1
Product Key	CL1321
Catalog Page	Page 66 (C-4-2019)
GTIN	4017918148164
Weight per Piece (including packing)	72.52 g
Weight per Piece (excluding packing)	66.5 g
Customs tariff number	85363010
Country of origin	IN

VAL-MS BE - Type 2 surge protection base element



2817741

<https://www.phoenixcontact.com/in/products/2817741>

Technical Data

Notes

General

Note	For installation into a touch protected cabinet. For applications with $U_C > 500$ V distances at the side and distances at the connection area must be minimum of 5 mm between different active parts including earthed parts.
------	---

Product properties

IEC test classification	II
	T2
EN type	T2
Type	Base element, DIN rail mounting
Product type	Base element
Product family	VALVETRAB MS
Number of positions	1
Surge protection fault message	none

Insulation characteristics

Overvoltage category	III
Pollution degree	2

Electrical properties

Nominal frequency f_N	50 Hz (60 Hz)
-------------------------	---------------

Connection data

Connection method	Screw connection
Screw thread	M5
Tightening torque	3 Nm (1.5 mm ² ... 16 mm ²) 4.5 Nm (25 mm ² ... 35 mm ²)
Stripping length	16 mm
Conductor cross section flexible	1.5 mm ² ... 25 mm ²
Conductor cross section rigid	1.5 mm ² ... 35 mm ²
Conductor cross section AWG	15 ... 2
Connection method	Fork-type cable lug
Conductor cross section flexible	1.5 mm ² ... 16 mm ²

Dimensions

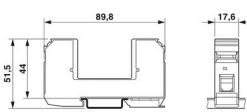
Dimensional drawing	
Width	17.6 mm

VAL-MS BE - Type 2 surge protection base element



2817741

<https://www.phoenixcontact.com/in/products/2817741>

Height	89.8 mm
Depth	51.5 mm (incl. DIN rail 7.5 mm)
Horizontal pitch	1 Div.

Material specifications

Color	jet black RAL 9005
Flammability rating according to UL 94	V-0
CTI value of material	600
Insulating material	PA 6.6
Material group	I
Housing material	PA 6.6

Mechanical properties

Mechanical data

Open side panel	No
-----------------	----

Protective circuit

Direction of action	1L-N/PE
Nominal frequency f_N	50 Hz (60 Hz)
Maximum continuous voltage U_C	600 V AC
Rated load current I_L	80 A
Short-circuit current rating I_{SCCR}	25 kA
Max. backup fuse with V-type through wiring	80 A (gG)
Max. backup fuse with branch wiring	125 A (gG)

Environmental and real-life conditions

Ambient conditions

Degree of protection	IP20 (only when all terminal points are used)
Ambient temperature (operation)	-40 °C ... 80 °C
Ambient temperature (storage/transport)	-40 °C ... 80 °C
Altitude	≤ 2000 m (amsl (above mean sea level))
Permissible humidity (operation)	5 % ... 95 %
Shock (operation)	25g (Half-sine / 11 ms / 3x ±X, ±Y, ±Z)
Vibration (operation)	5g (10 ... 500 Hz / 2.5 h / X, Y, Z)

Approvals

UL specifications

Nominal voltage	690 V AC
SPD Type	4CA

UL connection data

Tightening torque	30 lb _f -in.
Conductor cross section AWG	14 ... 2

VAL-MS BE - Type 2 surge protection base element



2817741

<https://www.phoenixcontact.com/in/products/2817741>

Standards and regulations

Standards/specifications	IEC 61643-11
Standards/specifications	EN 61643-11

Mounting

Mounting type	DIN rail: 35 mm
---------------	-----------------

VAL-MS BE - Type 2 surge protection base element

2817741

<https://www.phoenixcontact.com/in/products/2817741>

Drawings

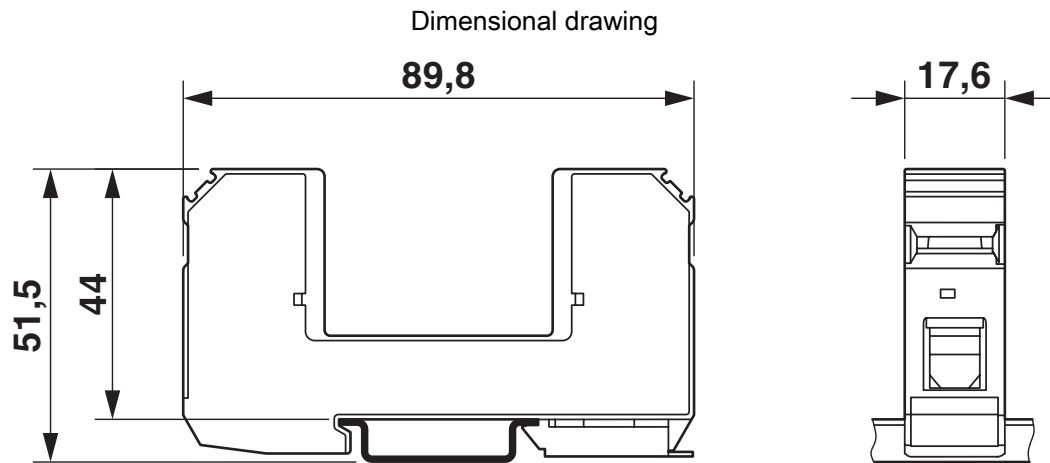

Circuit diagram



VAL-MS BE - Type 2 surge protection base element



2817741

<https://www.phoenixcontact.com/in/products/2817741>

Approvals



cUL Recognized

Approval ID: FILE E 330181



UL Recognized

Approval ID: FILE E 330181



IECEE CB Scheme

Approval ID: AT 2905/M1



EAC

Approval ID: EAC-Zulassung



KEMA-KEUR

Approval ID: 71-113273 REV.1



DNV GL

Approval ID: TAE000041M



EAC

Approval ID: RU C-DE.*09.B.00169



CSA

Approval ID: 13631



ÖVE

Approval ID: 18583-001-16



ÖVE

Approval ID: 18583-001-17

VAL-MS BE - Type 2 surge protection base element



2817741

<https://www.phoenixcontact.com/in/products/2817741>

Classifications

ECLASS

ECLASS-11.0

27130803

ETIM

ETIM 8.0

EC000472

UNSPSC

UNSPSC 21.0

39121600

VAL-MS BE - Type 2 surge protection base element



2817741

<https://www.phoenixcontact.com/in/products/2817741>

Environmental Product Compliance

China RoHS	Environmentally friendly use period: unlimited = EFUP-e
	No hazardous substances above threshold values

VAL-MS BE - Type 2 surge protection base element

2817741

<https://www.phoenixcontact.com/in/products/2817741>

Accessories

 Note: Applying some accessories below might limit this product.

MPB 18/1-10/1.0.0 - Wiring bridge

2830443

<https://www.phoenixcontact.com/in/products/2830443>



Wiring bridge for modules with connecting pitch 17.5 mm, 1-phase, 10 pitches with contact sequence 1-0-0

 Max. current carrying capacity: 125 A

MPB 18/4- 8 - Wiring bridge

2809283

<https://www.phoenixcontact.com/in/products/2809283>



Wiring bridge for modules with connecting pitch 17.5 mm, 4-phase, 8-pos.

 Max. current carrying capacity: 80 A

VAL-MS BE - Type 2 surge protection base element

2817741

<https://www.phoenixcontact.com/in/products/2817741>



MPB 18/3- 6 - Wiring bridge

2809241

<https://www.phoenixcontact.com/in/products/2809241>

Wiring bridge for modules with connecting pitch 17.5 mm, 3-phase, 6-pos.

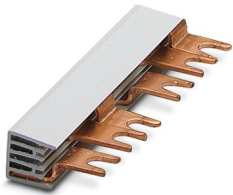

 Max. current carrying capacity: 80 A

MPB 18/1-57 - Wiring bridge

2809238

<https://www.phoenixcontact.com/in/products/2809238>

Wiring bridge for modules with connecting pitch 17.5 mm, 1-phase, 57-pos.



 Max. current carrying capacity: 125 A

VAL-MS BE - Type 2 surge protection base element

2817741

<https://www.phoenixcontact.com/in/products/2817741>

MPB 18/1-12 - Wiring bridge

2748593

<https://www.phoenixcontact.com/in/products/2748593>



Wiring bridge for modules with connecting pitch 17.5 mm, 1-phase, 12-pos.

 Max. current carrying capacity: 125 A

MPB 18/1- 9 - Wiring bridge

2748580

<https://www.phoenixcontact.com/in/products/2748580>



Wiring bridge for modules with connecting pitch 17.5 mm, 1-phase, 9-pos.

 Max. current carrying capacity: 125 A

VAL-MS BE - Type 2 surge protection base element

2817741

<https://www.phoenixcontact.com/in/products/2817741>

MPB 18/1- 8 - Wiring bridge

2748577

<https://www.phoenixcontact.com/in/products/2748577>



Wiring bridge for modules with connecting pitch 17.5 mm, 1-phase, 8-pos.

 Max. current carrying capacity: 125 A

MPB 18/1- 6 - Wiring bridge

2748564

<https://www.phoenixcontact.com/in/products/2748564>



Wiring bridge for modules with connecting pitch 17.5 mm, 1-phase, 6-pos.

 Max. current carrying capacity: 125 A

VAL-MS BE - Type 2 surge protection base element

2817741

<https://www.phoenixcontact.com/in/products/2817741>

MPB 18/1- 4 - Wiring bridge

2809225

<https://www.phoenixcontact.com/in/products/2809225>

Wiring bridge for modules with connecting pitch 17.5 mm, 1-phase, 4-pos.



 Max. current carrying capacity: 125 A

MPB 18/1- 3 - Wiring bridge

2809212

<https://www.phoenixcontact.com/in/products/2809212>

Wiring bridge for modules with connecting pitch 17.5 mm, 1-phase, 3-pos.



 Max. current carrying capacity: 125 A

VAL-MS BE - Type 2 surge protection base element

2817741

<https://www.phoenixcontact.com/in/products/2817741>

MPB 18/1- 2 - Wiring bridge

2809209

<https://www.phoenixcontact.com/in/products/2809209>



Wiring bridge for modules with connecting pitch 17.5 mm, 1-phase, 2-pos.

 Max. current carrying capacity: 125 A

ZBN 18,LGS:ERDE - Marker for terminal blocks

2749589

<https://www.phoenixcontact.com/in/products/2749589>



Marker for terminal blocks, Strip, white, labeled, horizontal: Grounding symbol, mounting type: snapped, for terminal block width: 18 mm, lettering field size: 18 x 5 mm, Number of individual labels: 5

VAL-MS BE - Type 2 surge protection base element

2817741

<https://www.phoenixcontact.com/in/products/2817741>

ZBN 18,LGS:L1-N,ERDE - Marker for terminal blocks

2749576

<https://www.phoenixcontact.com/in/products/2749576>

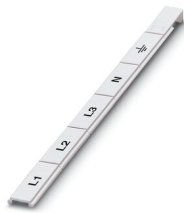

Marker for terminal blocks, Strip, white, labeled, horizontal: L1, L2, L3, N, GND, mounting type: snapped, for terminal block width: 18 mm, lettering field size: 18 x 5 mm, Number of individual labels: 5

ZBN 18:UNBEDRUCKT - Zack marker strip

2809128

<https://www.phoenixcontact.com/in/products/2809128>



Zack marker strip, Strip, white, unlabeled, can be labeled with: CMS-P1-PLOTTER, PLOTMARK, mounting type: snapped, for terminal block width: 18 mm, lettering field size: 18 x 5 mm, Number of individual labels: 5

VAL-MS BE - Type 2 surge protection base element



2817741

<https://www.phoenixcontact.com/in/products/2817741>

B-STIFT - Marker pen

1051993

<https://www.phoenixcontact.com/in/products/1051993>



Marker pen, for manual labeling of unprinted Zack strips, smear-proof and waterproof, line thickness 0.5 mm

DK-BIC-35 - Feed-through terminal block

2749880

<https://www.phoenixcontact.com/in/products/2749880>



Feed-through terminal block for VAL and FLT applications

VAL-MS BE - Type 2 surge protection base element

2817741

<https://www.phoenixcontact.com/in/products/2817741>

MPB 18/1- 2 - Wiring bridge

2809209

<https://www.phoenixcontact.com/in/products/2809209>

Wiring bridge for modules with connecting pitch 17.5 mm, 1-phase, 2-pos.



MPB 18/1- 3 - Wiring bridge

2809212

<https://www.phoenixcontact.com/in/products/2809212>

Wiring bridge for modules with connecting pitch 17.5 mm, 1-phase, 3-pos.



VAL-MS BE - Type 2 surge protection base element

2817741

<https://www.phoenixcontact.com/in/products/2817741>

MPB 18/1- 4 - Wiring bridge

2809225

<https://www.phoenixcontact.com/in/products/2809225>



Wiring bridge for modules with connecting pitch 17.5 mm, 1-phase, 4-pos.

MPB 18/1- 6 - Wiring bridge

2748564

<https://www.phoenixcontact.com/in/products/2748564>



Wiring bridge for modules with connecting pitch 17.5 mm, 1-phase, 6-pos.

VAL-MS BE - Type 2 surge protection base element

2817741

<https://www.phoenixcontact.com/in/products/2817741>

MPB 18/1- 7 BU - Wiring bridge

2856278

<https://www.phoenixcontact.com/in/products/2856278>



Wiring bridge for modules with connecting pitch 17.5 mm, 1-phase, 7-pos., color: Blue

MPB 18/1- 8 BU - Wiring bridge

2858470

<https://www.phoenixcontact.com/in/products/2858470>

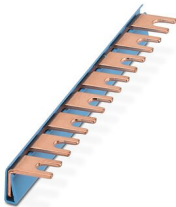

Wiring bridge for modules with connecting pitch 17.5 mm, 1-phase, 8-pos., color: Blue

VAL-MS BE - Type 2 surge protection base element

2817741

<https://www.phoenixcontact.com/in/products/2817741>

MPB 18/1- 8 - Wiring bridge

2748577

<https://www.phoenixcontact.com/in/products/2748577>



Wiring bridge for modules with connecting pitch 17.5 mm, 1-phase, 8-pos.

MPB 18/1- 9 - Wiring bridge

2748580

<https://www.phoenixcontact.com/in/products/2748580>



Wiring bridge for modules with connecting pitch 17.5 mm, 1-phase, 9-pos.

VAL-MS BE - Type 2 surge protection base element



2817741

<https://www.phoenixcontact.com/in/products/2817741>

MPB 18/1-12 - Wiring bridge

2748593

<https://www.phoenixcontact.com/in/products/2748593>



Wiring bridge for modules with connecting pitch 17.5 mm, 1-phase, 12-pos.

MPB 18/1-57 - Wiring bridge

2809238

<https://www.phoenixcontact.com/in/products/2809238>



Wiring bridge for modules with connecting pitch 17.5 mm, 1-phase, 57-pos.

VAL-MS BE - Type 2 surge protection base element



2817741

<https://www.phoenixcontact.com/in/products/2817741>

MPB 18/3- 6 - Wiring bridge

2809241

<https://www.phoenixcontact.com/in/products/2809241>

Wiring bridge for modules with connecting pitch 17.5 mm, 3-phase, 6-pos.

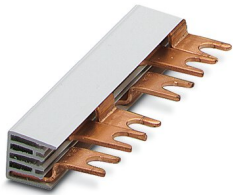

MPB 18/4- 8 - Wiring bridge

2809283

<https://www.phoenixcontact.com/in/products/2809283>

Wiring bridge for modules with connecting pitch 17.5 mm, 4-phase, 8-pos.



Phoenix Contact 2023 © - all rights reserved

<https://www.phoenixcontact.com>

PHOENIX CONTACT (I) Pvt. Ltd.

A-58/2, Okhla Industrial Area, Phase - II, New Delhi-110 020

+91.1275.71420

info@phoenixcontact.co.in