

MACX MCR-T-UIREL-UP - Temperature measuring transducer



2811378

<https://www.phoenixcontact.com/in/products/2811378>

Please be informed that the data shown in this PDF document is generated from our Online Catalog. Please find the complete data in the user documentation. Our General Terms of Use for Downloads are valid.



Freely programmable temperature transducer with analog output and 3 limit value relays, standard configuration, resistance thermometer in 2-, 3-, or 4-conductor technology, thermocouples, electrical isolation, wide-range power supply, screw connection, SIL, PL.

Your advantages

- Cold junction compensation with separate plug
- Configuration via software (FDT/DTM) or IFS-OP-UNIT operator interface and display unit
- Up to SIL 2 in accordance with EN 61508
- Installation in zone 2, protection type "n" (EN 60079-15) permitted
- Programming during operation and also voltage-free using IFS-USB-PROG-ADAPTER programming adapter
- Plug-in screw or spring-cage connection technology (Push-in technology)
- Freely programmable input and output
- Input for resistance thermometers, thermocouples, resistance-type sensors, potentiometers, and mV sources
- Measure differential temperatures
- Three limit value relays, can be used in combination as a safe limit value relay
- Inverse output signal ranges as an option

Commercial Data

Item number	2811378
Packing unit	1 pc
Minimum order quantity	1 pc
Sales Key	CK1
Product Key	CK1121
Catalog Page	Page 126 (C-5-2019)
GTIN	4046356288903
Weight per Piece (including packing)	351.6 g
Weight per Piece (excluding packing)	351.6 g
Customs tariff number	85437090
Country of origin	DE

MACX MCR-T-UIREL-UP - Temperature measuring transducer



2811378

<https://www.phoenixcontact.com/in/products/2811378>

Technical Data

Product properties

Product type	Temperature transmitter
Product family	MACX Analog
Type	Signal conditioners with SIL and PL Functional Safety
Configuration	DIP switches
	Software

Insulation characteristics

Overvoltage category	II
Pollution degree	2

Electrical properties

Electrical isolation	4-way isolation
Step response (0–99%)	≤ 1.75 s (SIL on)
	1.3 s (SIL off)
Maximum temperature coefficient	0.01 %/K
Maximum transmission error	0.1 % (e.g. for Pt 100, 300 K span, 4 ... 20 mA)

Electrical isolation Input/output/power supply

Rated insulation voltage	300 V _{rms}
Test voltage	2.5 kV AC (50 Hz, 60 s)
Insulation	Safe isolation in accordance with IEC/EN 61010-1

Electrical isolation Input/output

Electrical isolation	375 V (Peak value in accordance with IEC/EN 60079-11)
----------------------	---

Electrical isolation Input/power supply

Electrical isolation	375 V (Peak value in accordance with IEC/EN 60079-11)
----------------------	---

Electrical isolation Input/switching output

Electrical isolation	375 V (Peak value in accordance with IEC/EN 60079-11)
----------------------	---

Supply

Nominal supply voltage range	24 V AC/DC ... 230 V AC/DC (50/60 Hz)
Supply voltage range	19.2 V AC/DC ... 253 V AC/DC (24 V AC/DC ... 230 V AC/DC (-20 % ... +10 %, 50/60 Hz))
Power consumption	< 2.4 W

Input data

Signal

Number of inputs	1
Input signal	Temperature
	Resistor

MACX MCR-T-UIREL-UP - Temperature measuring transducer



2811378

<https://www.phoenixcontact.com/in/products/2811378>

	Voltage
Measurement	
Sensor types (RTD) that can be used	Pt, Ni, Cu sensors: 2, 3, 4-wire
Sensor types that can be used (TC)	B, E, J, K, N, R, S, T, L, U, CA, DA, A1G, A2G, A3G, MG, LG
Temperature measuring range	-250 °C ... 2500 °C (Range depending on the sensor type)
Linear resistance measuring range	0 Ω ... 50 kΩ
Potentiometer resistance range	0 Ω ... 50 kΩ
Linear mV signal range	-1000 mV ... 1000 mV

Output data

Switching: Relay

Configurable/programmable	Yes
Contact type	3 changeover contacts
Contact material	AgSnO ₂ , hard gold-plated
Maximum switching voltage	250 V AC (250 V DC)
Max. switching current	2 A (250 V AC)
	0.1 A (250 V DC)
	2 A (28 V DC)

Signal: Current

Number of outputs	1
Configurable/programmable	Yes
Max. voltage output signal	± 11 V
Current output signal	4 mA ... 20 mA (in the case of SIL; further free configuration without SIL)
Max. current output signal	22 mA
Load/output load voltage output	≥ 10 kΩ
Load/output load current output	≤ 600 Ω (20 mA)
Behavior in the event of a sensor error	according to NE 43 or freely configurable

Connection data

Connection method	Screw connection
Stripping length	7 mm
Screw thread	M3
Conductor cross section rigid	0.2 mm ² ... 2.5 mm ²
Conductor cross section flexible	0.2 mm ² ... 2.5 mm ²
Conductor cross section AWG	24 ... 14

Ex data

Ex installation (EPL)	Gc
	Div. 2

Signaling

MACX MCR-T-UIREL-UP - Temperature measuring transducer



2811378

<https://www.phoenixcontact.com/in/products/2811378>

Error indication	Red LED
------------------	---------

Dimensions

Width	35 mm
Height	112.5 mm
Depth	113.7 mm
Depth NS 35/7,5	114.5 mm (Snapped onto DIN rail NS 35/7,5 in accordance with EN 60715)

Material specifications

Flammability rating according to UL 94	V0 (Housing)
Housing material	PA 6.6-FR

Environmental and real-life conditions

Ambient conditions

Ambient temperature (operation)	-20 °C ... 65 °C
Ambient temperature (storage/transport)	-40 °C ... 85 °C
Permissible humidity (operation)	typ. 5 % ... 95 % (non-condensing)

Altitude range (≤ 2000 m)

Altitude	≤ 2000 m (The technical data refers to altitudes ≤2000 m above mean sea level. For altitudes >2000 m above mean sea level, refer to the data sheet.)
----------	--

Altitude range (≤ 3000 m)

Height range	> 2000 m ... 3000 m
Ambient temperature (operation)	-20 °C ... 55 °C

Altitude range (≤ 4000 m)

Height range	> 3000 m ... 4000 m
Ambient temperature (operation)	-20 °C ... 50 °C

Altitude range (≤ 5000 m)

Height range	> 4000 m ... 5000 m
Ambient temperature (operation)	-20 °C ... 45 °C

Approvals

CE

Certificate	CE-compliant
-------------	--------------

ATEX

Identification	<input type="checkbox"/> II 3 G Ex ec ic nC IIC T4 Gc
Certificate	PxCIF20ATEX2811378

UKCA Ex (UKEX)

Identification	<input type="checkbox"/> II 3 G Ex ec ic nC IIC T4 Gc X
----------------	---

MACX MCR-T-UIREL-UP - Temperature measuring transducer



2811378

<https://www.phoenixcontact.com/in/products/2811378>

Certificate	CML 22UKEX3529X
-------------	-----------------

IECEX

Identification	Ex ec ic nC IIC T4 Gc
Certificate	IECEX IBE 10.0004 X

UL, USA/Canada

Identification	UL 508 Listed
	Class I, Div. 2, Groups A, B, C, D T6
	Class I, Zone 2, Group IIC T6

Shipbuilding approval

Certificate	DNV GL TAA000020C
-------------	-------------------

Safety Integrity Level (SIL, IEC 61508)

Identification	2
----------------	---

Performance Level (ISO 13849)

Identification	d
----------------	---

INMETRO

Identification	Ex ec ic nC IIC T4 Gc
Certificate	DNV 18.0143 X

EAC Ex

Identification	<input type="checkbox"/> 2Ex ec ic IIC T4 Gc
Certificate	BY/112 02.01 TP012 103.01 00078

DNV GL data

Temperature	B
Humidity	B
Vibration	A
EMC	A
Enclosure	Required protection according to the Rules shall be provided upon installation on board

EMC data

Noise immunity	EN 61000-6-2
Note	When being exposed to interference, there may be minimal deviations.
Electromagnetic compatibility	Conformance with EMC directive
Noise emission	EN 61000-6-4

Standards and regulations

Electrical isolation	4-way isolation
----------------------	-----------------

Mounting

MACX MCR-T-UIREL-UP - Temperature measuring transducer



2811378

<https://www.phoenixcontact.com/in/products/2811378>

Mounting type

DIN rail mounting

MACX MCR-T-UIREL-UP - Temperature measuring transducer

2811378

<https://www.phoenixcontact.com/in/products/2811378>

Drawings

Block diagram

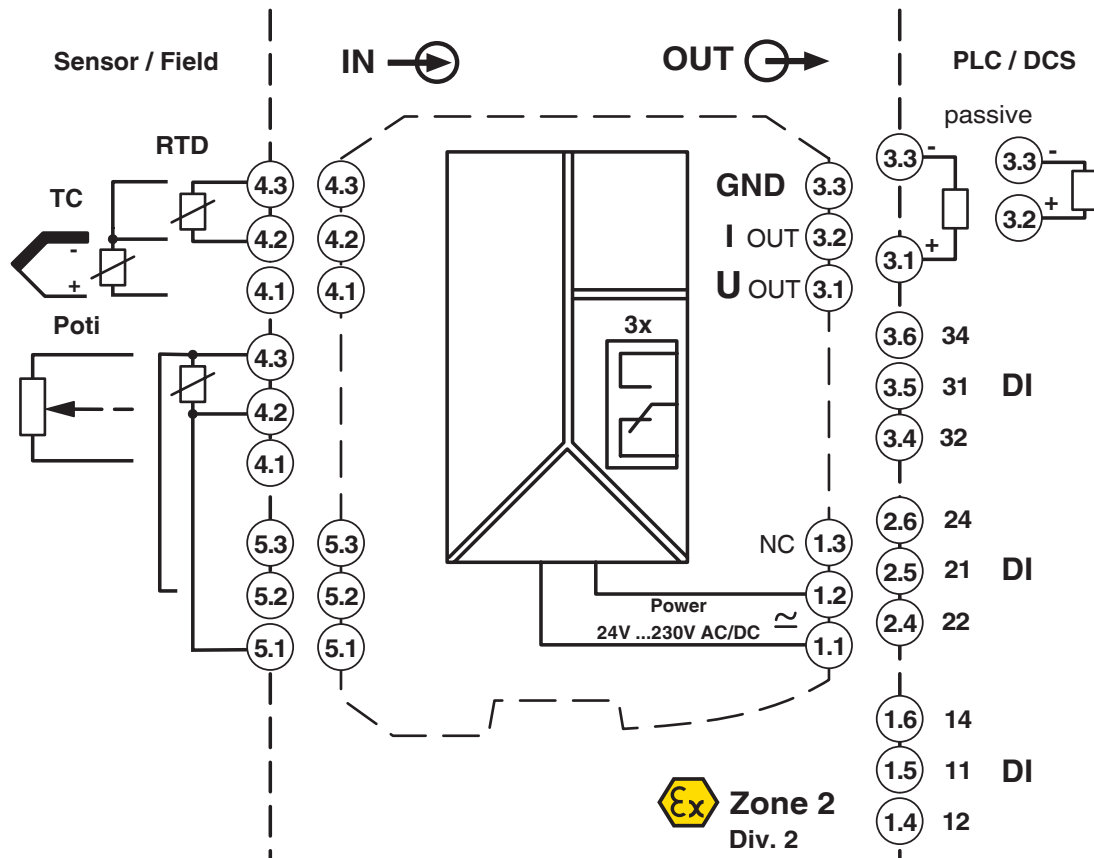

MACX MCR-T-UIREL-UP - Temperature measuring transducer



2811378

<https://www.phoenixcontact.com/in/products/2811378>

Approvals



DNV GL

Approval ID: TAA000020C



UL Listed

Approval ID: FILE E 238705



cUL Listed

Approval ID: FILE E 238705



Functional Safety

Approval ID: SEBS-A.150520/17 V1



cUL Listed

Approval ID: FILE E 199827



UL Listed

Approval ID: FILE E 199827



EAC Ex

Approval ID: TP012 103.01 00078



IECEX

Approval ID: IECEX IBE 10.0004X



ATEX

Approval ID: IBExU 10 ATEX 1044

MACX MCR-T-UIREL-UP - Temperature measuring transducer



2811378

<https://www.phoenixcontact.com/in/products/2811378>

Classifications

ECLASS

ECLASS-11.0	27210129
ECLASS-12.0	27210129
ECLASS-13.0	27210129

ETIM

ETIM 8.0	EC002919
----------	----------

UNSPSC

UNSPSC 21.0	41112100
-------------	----------

MACX MCR-T-UIREL-UP - Temperature measuring transducer



2811378

<https://www.phoenixcontact.com/in/products/2811378>

Environmental Product Compliance

REACH SVHC	Lead 7439-92-1
China RoHS	Environmentally Friendly Use Period = 50 years
	For information on hazardous substances, refer to the manufacturer's declaration available under "Downloads"

MACX MCR-T-UIREL-UP - Temperature measuring transducer

2811378

<https://www.phoenixcontact.com/in/products/2811378>

Accessories

MACX MCR-PTB - Power and error message module

2865625

<https://www.phoenixcontact.com/in/products/2865625>



Power and fault signaling module with screw connection, including corresponding ME 17,5 TBUS 1,5/ 5-ST-3,81 GY DIN rail connector

MACX MCR-PTB-SP - Power and error message module

2924184

<https://www.phoenixcontact.com/in/products/2924184>



Power and fault signaling module with Push-in connection, including corresponding ME 17,5 TBUS 1,5/ 5-ST-3,81 GY DIN rail connector

MACX MCR-T-UIREL-UP - Temperature measuring transducer



2811378

<https://www.phoenixcontact.com/in/products/2811378>

QUINT4-SYS-PS/1AC/24DC/2.5/SC - Power supply unit

2904614

<https://www.phoenixcontact.com/in/products/2904614>



Primary-switched power supply, QUINT POWER, screw connection, DIN rail mounting, supply of devices possible via the TBUS DIN rail connector, protective coating, input: single-phase, output: 24 V DC/2.5 A

IFS-USB-PROG-ADAPTER - Programming adapter

2811271

<https://www.phoenixcontact.com/in/products/2811271>



Programming adapter with USB interface, for programming with software. The USB driver is included in the software solutions for the products to be programmed, such as measuring transducers or motor managers.

MACX MCR-T-UIREL-UP - Temperature measuring transducer

2811378

<https://www.phoenixcontact.com/in/products/2811378>

MACX MCR-I20 - Plug

2905680

<https://www.phoenixcontact.com/in/products/2905680>



Connection terminal block for current signals, +20 mA ... -20 mA, for safe switching of limit values, in combination with MACX ...-T-UI... temperature transducers.

MACX MCR-CJC - Plug

2924993

<https://www.phoenixcontact.com/in/products/2924993>



Plug for cold junction compensation for thermocouples, for safe switching of limit values, in combination with MACX ...-T-UI... temperature transducers.

MACX MCR-T-UIREL-UP - Temperature measuring transducer



2811378

<https://www.phoenixcontact.com/in/products/2811378>

IFS-BT-PROG-ADAPTER - Adapter

2905872

<https://www.phoenixcontact.com/in/products/2905872>

Bluetooth adapter with micro USB and S-PORT interface for wireless communication with the MINI Analog, MINI Analog Pro, MACX Analog, Interface System Gateways, and PLC logic device series.



MPS-IH WH - Insulating sleeve

0201663

<https://www.phoenixcontact.com/in/products/0201663>

Insulating sleeve, color: white



MACX MCR-T-UIREL-UP - Temperature measuring transducer

2811378

<https://www.phoenixcontact.com/in/products/2811378>

MPS-IH RD - Insulating sleeve

0201676

<https://www.phoenixcontact.com/in/products/0201676>

Insulating sleeve, color: red



MPS-IH BU - Insulating sleeve

0201689

<https://www.phoenixcontact.com/in/products/0201689>

Insulating sleeve, color: blue

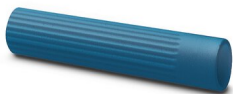

MACX MCR-T-UIREL-UP - Temperature measuring transducer



2811378

<https://www.phoenixcontact.com/in/products/2811378>

MPS-IH YE - Insulating sleeve

0201692

<https://www.phoenixcontact.com/in/products/0201692>

Insulating sleeve, color: yellow



MPS-IH GN - Insulating sleeve

0201702

<https://www.phoenixcontact.com/in/products/0201702>

Insulating sleeve, color: green



MACX MCR-T-UIREL-UP - Temperature measuring transducer



2811378

<https://www.phoenixcontact.com/in/products/2811378>

MPS-IH GY - Insulating sleeve

0201728

<https://www.phoenixcontact.com/in/products/0201728>

Insulating sleeve, color: gray



MPS-IH BK - Insulating sleeve

0201731

<https://www.phoenixcontact.com/in/products/0201731>

Insulating sleeve, color: black



MACX MCR-T-UIREL-UP - Temperature measuring transducer



2811378

<https://www.phoenixcontact.com/in/products/2811378>

MPS-MT - Test plugs

0201744

<https://www.phoenixcontact.com/in/products/0201744>



Test plugs, with solder connection up to 1 mm² conductor cross section, number of positions: 1, color: gray

UC-EMLP (11X9) - Plastic label

0819291

<https://www.phoenixcontact.com/in/products/0819291>



Plastic label, Sheet, white, unlabeled, can be labeled with: BLUEMARK ID COLOR, BLUEMARK ID, BLUEMARK CLED, PLOTMARK, CMS-P1-PLOTTER, mounting type: adhesive, lettering field size: 11 x 9 mm, Number of individual labels: 10

MACX MCR-T-UIREL-UP - Temperature measuring transducer



2811378

<https://www.phoenixcontact.com/in/products/2811378>

UC-EMLP (11X9) YE - Plastic label

0822602

<https://www.phoenixcontact.com/in/products/0822602>

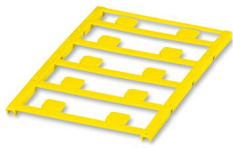

Plastic label, Sheet, yellow, unlabeled, can be labeled with: BLUEMARK ID COLOR, BLUEMARK ID, BLUEMARK CLED, PLOTMARK, CMS-P1-PLOTTER, mounting type: adhesive, lettering field size: 11 x 9 mm, Number of individual labels: 10

UC-EMLP (11X9) CUS - Plastic label

0824547

<https://www.phoenixcontact.com/in/products/0824547>



Plastic label, can be ordered: by sheet, white, labeled according to customer specifications, mounting type: adhesive, lettering field size: 11 x 9 mm

MACX MCR-T-UIREL-UP - Temperature measuring transducer



2811378

<https://www.phoenixcontact.com/in/products/2811378>

UC-EMLP (11X9) YE CUS - Plastic label

0824548

<https://www.phoenixcontact.com/in/products/0824548>

Plastic label, can be ordered: by sheet, yellow, labeled according to customer specifications, mounting type: adhesive, lettering field size: 11 x 9 mm

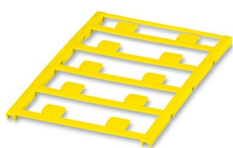

UC-EMLP (11X9) SR - Plastic label

0828094

<https://www.phoenixcontact.com/in/products/0828094>

Plastic label, Sheet, silver, unlabeled, can be labeled with: BLUEMARK ID COLOR, BLUEMARK ID, BLUEMARK CLED, PLOTMARK, CMS-P1-PLOTTER, mounting type: adhesive, lettering field size: 11 x 9 mm, Number of individual labels: 10

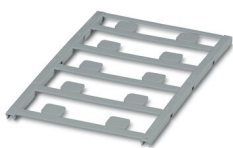

MACX MCR-T-UIREL-UP - Temperature measuring transducer



2811378

<https://www.phoenixcontact.com/in/products/2811378>

UC-EMLP (11X9) SR CUS - Plastic label

0828098

<https://www.phoenixcontact.com/in/products/0828098>



Plastic label, can be ordered: by sheet, silver, labeled according to customer specifications, mounting type: adhesive, lettering field size: 11 x 9 mm, Number of individual labels: 10

US-EMLP (11X9) - Plastic label

0828789

<https://www.phoenixcontact.com/in/products/0828789>



Plastic label, Card, white, unlabeled, can be labeled with: BLUEMARK ID COLOR, BLUEMARK ID, THERMOMARK PRIME, THERMOMARK CARD 2.0, THERMOMARK CARD, mounting type: adhesive, lettering field size: 11 x 9 mm, Number of individual labels: 135

MACX MCR-T-UIREL-UP - Temperature measuring transducer



2811378

<https://www.phoenixcontact.com/in/products/2811378>

US-EMLP (11X9) YE - Plastic label

0828871

<https://www.phoenixcontact.com/in/products/0828871>



Plastic label, Card, yellow, unlabeled, can be labeled with: BLUEMARK ID COLOR, BLUEMARK ID, THERMOMARK PRIME, THERMOMARK CARD 2.0, THERMOMARK CARD, mounting type: adhesive, lettering field size: 11 x 9 mm, Number of individual labels: 135

US-EMLP (11X9) SR - Plastic label

0828872

<https://www.phoenixcontact.com/in/products/0828872>



Plastic label, Card, silver, unlabeled, can be labeled with: BLUEMARK ID COLOR, BLUEMARK ID, THERMOMARK PRIME, THERMOMARK CARD 2.0, THERMOMARK CARD, mounting type: adhesive, lettering field size: 11 x 9 mm, Number of individual labels: 135

MACX MCR-T-UIREL-UP - Temperature measuring transducer



2811378

<https://www.phoenixcontact.com/in/products/2811378>

LS-EMLP (11X9) WH - Device marker

0831678

<https://www.phoenixcontact.com/in/products/0831678>

Device marker, Sheet, white, unlabeled, can be labeled with: TOPMARK NEO, TOPMARK LASER: without print, mounting type: adhesive, lettering field size: 11 x 9 mm, Number of individual labels: 255



LS-EMLP (11X9) SR - Device marker

0831705

<https://www.phoenixcontact.com/in/products/0831705>

Device marker, Sheet, silver, unlabeled, can be labeled with: TOPMARK NEO, TOPMARK LASER: without print, mounting type: adhesive, lettering field size: 11 x 9 mm, Number of individual labels: 255

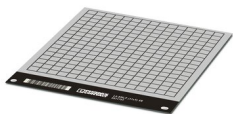

MACX MCR-T-UIREL-UP - Temperature measuring transducer



2811378

<https://www.phoenixcontact.com/in/products/2811378>

LS-EMLP (11X9) YE - Device marker

0831732

<https://www.phoenixcontact.com/in/products/0831732>

Device marker, Sheet, yellow, unlabeled, can be labeled with: TOPMARK NEO, TOPMARK LASER: without print, mounting type: adhesive, lettering field size: 11 x 9 mm, Number of individual labels: 255

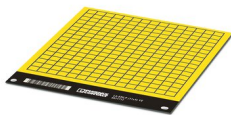

Phoenix Contact 2023 © - all rights reserved
<https://www.phoenixcontact.com>

PHOENIX CONTACT (I) Pvt. Ltd.
A-58/2, Okhla Industrial Area, Phase - II, New Delhi-110 020

+91.1275.71420
info@phoenixcontact.co.in