

PSI-MOS-PROFIB/FO1300 T - FO converters



2708892

<https://www.phoenixcontact.com/in/products/2708892>

Please be informed that the data shown in this PDF document is generated from our Online Catalog. Please find the complete data in the user documentation. Our General Terms of Use for Downloads are valid.



Fiber optic converter with integrated optical diagnostics, alarm contact, for PROFIBUS up to 12 Mbps, T-coupler with two fiber optic interfaces (SC-Duplex), 1300 nm, for fiberglass cable

Product Description

The **PSI-MOS-PROFIB/FO...** devices convert copper-based PROFIBUS interfaces to fiber optics. The integrated optical diagnostics allow permanent monitoring of the FO paths during installation and also during operation. The floating switch contact is activated when the signal output on the fiber optic paths drops to a critical level. The **PSI-MOS-PROFIB/FO...** T T-couplers allow the interface to be converted for two **FO cables**. They can be used to create linear structures and ring structures for increased system availability.

Your advantages

- Supply voltage and data signals routed through the DIN rail connectors
- Can be combined with the PSI copper repeater in a modular way using DIN rail connectors
- Connections can be plugged in via a COMBICON screw terminal block
- Automatic data rate detection or fixed data rate setting via DIP switches
- Redundant power supply possible by means of optional system power supply unit
- High-quality electrical isolation between all interfaces (PROFIBUS // fiber optic ports // power supply // DIN rail connector)
- Approved for use in zone 2
- Integrated optical diagnostics for continuous monitoring of FO paths
- Floating switch contact for advance warning of critical FO paths
- Bit retiming for any cascading depth
- Suitable for all data rates up to 12 Mbps

Commercial Data

Item number	2708892
Packing unit	1 pc
Minimum order quantity	1 pc
Sales Key	DNC
Product Key	DNC211
Catalog Page	Page 431 (C-6-2019)
GTIN	4046356174053
Weight per Piece (including packing)	251.55 g
Weight per Piece (excluding packing)	178.12 g
Customs tariff number	85176200

PSI-MOS-PROFIB/FO1300 T - FO converters



2708892

<https://www.phoenixcontact.com/in/products/2708892>

Country of origin	DE
-------------------	----

Technical Data

Notes

Utilization restriction

CCCex note	Use in potentially explosive areas is not permitted in China.
------------	---

Product properties

Product type	Media converter
MTTF	614 Years (SN 29500 standard, temperature 25°C, operating cycle 21%)
	272 Years (SN 29500 standard, temperature 40°C, operating cycle 34.25%)
	113 Years (SN 29500 standard, temperature 40°C, operating cycle 100%)
MTBF	307 Years (Telcordia standard, 25°C temperature, 21% operating cycle (5 days a week, 8 hours a day))
	64 Years (Telcordia standard, 40°C temperature, 34.25% operating cycle (5 days a week, 12 hours a day))

Electrical properties

Electrical isolation	VCC // RS-485
Maximum power dissipation for nominal condition	2.04 W
Test voltage data interface/power supply	1.5 kV _{rms} (50 Hz, 1 min.)

Supply

Supply voltage range	18 V DC ... 32 V DC (via pluggable COMBICON screw terminal block)
Nominal supply voltage	24 V DC (in acc. with UL)
Typical current consumption	85 mA (24 V DC)
Max. current consumption	145 mA
	≤ 2 A (For operation in a joining station, via the DIN rail connector)
Connection method	COMBICON plug-in screw terminal block

Output data

Switching

Output name	Relay output
Output description	Alarm output
Number of outputs	1
Maximum switching voltage	60 V DC (Resistive Load, General Load)
	30 V AC (Resistive load)
	42 V AC (peak, resistive load)
Limiting continuous current	0.46 A

Connection data

PSI-MOS-PROFIB/FO1300 T - FO converters



2708892

<https://www.phoenixcontact.com/in/products/2708892>

Supply

Connection method	COMBICON plug-in screw terminal block
Stripping length	7 mm
Tightening torque	0.56 Nm ... 0.79 Nm

Interfaces

Bit distortion, input	± 35 % (permitted)
Bit distortion, output	< 6.25 %
Bit delay	< 1 bit (DIP 7 = OFF, standard operation)
	11 bit (DIP 7 = ON, redundancy operation)
Signal	PROFIBUS

Data: optical FO

No. of channels	2
Transmit capacity, minimum	-3.4 dBm (50/125 µm, multimode fiberglass)
	-4.7 dBm (62.5/125 µm, multimode fiberglass)
	-5.5 dBm (9/125 µm, singlemode fiberglass)
Transmission length incl. 3 dB system reserve	25 km (With F-G 50/125 0.7 dB/km at 1300 nm)
	22 km (with F-G 62.5/125 0.8 dB/km at 1300 nm)
	45 km (With F-E 9/125 0,4 dB/km at 1300 nm)
Transmission protocol	Protocol-transparent to the RS-485 interface
Connection method	SC duplex
Wavelength	1300 nm
Minimum receiver sensitivity	-25.5 dBm (Multi mode)
	-26.5 dBm (Singlemode)
Maximum receiver sensitivity	0 dBm
Transmission medium	Multi-mode fiberglass
	Single-mode fiberglass

Data: PROFIBUS acc. to IEC 61158, RS-485 2-wire, half duplex, automatic control

Serial transmission speed	≤ 12 Mbps
Connection method	D-SUB-9 female connector
Transmission length	≤ 1200 m (depending on the data rate, with shielded, twisted pair data cable)
Conductor cross section flexible max.	2.5 mm ²
Conductor cross section flexible min.	0.2 mm ²
Conductor cross section, rigid max.	2.5 mm ²
Conductor cross section, rigid min.	0.2 mm ²
Max. AWG conductor cross section, flexible	14
Min. AWG conductor cross section, flexible	24
Single-wire/terminal point, rigid AWG max.	14
Single-wire/terminal point, rigid AWG min.	24
Transmission medium	2-wire twisted pair, shielded
File format/coding	UART (11 Bit, NRZ)
Data direction switching	Automatic control

PSI-MOS-PROFIB/FO1300 T - FO converters



2708892

<https://www.phoenixcontact.com/in/products/2708892>

Output nominal voltage	5 V DC \pm 0.25 (50 mA)
------------------------	---------------------------

Dimensions

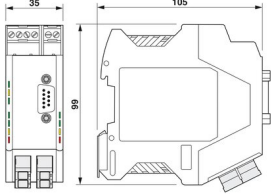
Dimensional drawing	
Width	35 mm
Height	105 mm
Depth	106 mm

Material specifications

Material Housing	PA 6.6-FR
------------------	-----------

Cable/line

FO cable

Fiber types	50/125 μ m
	62.5/125 μ m
	9/125 μ m
	Fiberglass

Environmental and real-life conditions

Ambient conditions

Degree of protection	IP20
Ambient temperature (operation)	-20 °C ... 60 °C
Ambient temperature (storage/transport)	-40 °C ... 85 °C
Altitude	\leq 5000 m (For restrictions, see the manufacturer's declaration for altitude operation)
	\leq 2000 m (Hazardous locations)
Permissible humidity (operation)	30 % ... 95 % (non-condensing)

Approvals

CE

Certificate	CE-compliant
-------------	--------------

ATEX

Identification	<input type="checkbox"/> II 3 G Ex ec IIC T4 Gc
Certificate	UL 21 ATEX 2550X
Note	Please follow the special installation instructions in the documentation!

IECEX

PSI-MOS-PROFIB/FO1300 T - FO converters



2708892

<https://www.phoenixcontact.com/in/products/2708892>

Identification	Ex ec IIC T4 Gc
Certificate	IECEX ULD 21.00013X

UL, USA/Canada

Identification	Class I, Zone 2, AEx ec IIC T4 Gc
	Ex ec IIC T4 Gc X
	Class I, Div. 2, Groups A, B, C, D

KC approval for South Korea

Certificate	MSIP-REI-PCK-2708892
-------------	----------------------

Corrosive gas test

Identification	ISA-S71.04-1985 G3 Harsh Group A
----------------	----------------------------------

EMC data

Noise immunity	EN 61000-6-2:2005
Electromagnetic compatibility	Conformance with EMC directive 89/336/EC
Noise emission	EN 55011

Electrostatic discharge

Standards/regulations	EN 61000-4-2
-----------------------	--------------

Electrostatic discharge

Contact discharge	± 6 kV
Discharge in air	± 8 kV
Comments	Criterion B

Electromagnetic HF field

Standards/regulations	EN 61000-4-3
-----------------------	--------------

Electromagnetic HF field

Field intensity	10 V/m
Comments	Criterion A

Fast transients (burst)

Standards/regulations	EN 61000-4-4
-----------------------	--------------

Fast transients (burst)

Input	± 2 kV
Signal	± 2 kV
Comments	Criterion B

Surge current load (surge)

Standards/regulations	EN 61000-4-5
-----------------------	--------------

Surge current load (surge)

Input	± 0.5 kV
Signal	± 1 kV
Comments	Criterion B

PSI-MOS-PROFIB/FO1300 T - FO converters



2708892

<https://www.phoenixcontact.com/in/products/2708892>

Conducted interference

Standards/regulations	EN 61000-4-6
-----------------------	--------------

Conducted interference

Comments	Criterion A
Voltage	10 V

Emitted interference

Standards/regulations	EN 55011
Comments	Class A, industrial applications

Criteria

Criterion A	Normal operating behavior within the specified limits.
Criterion B	Temporary impairment to operational behavior that is corrected by the device itself.

Standards and regulations

Free from substances that could impair the application of coating	in accordance with VW-AUDI-Seat central standard P-VW 3.10.7 57 65 0
---	--

Mounting

Mounting type	DIN rail mounting
---------------	-------------------

Drawings

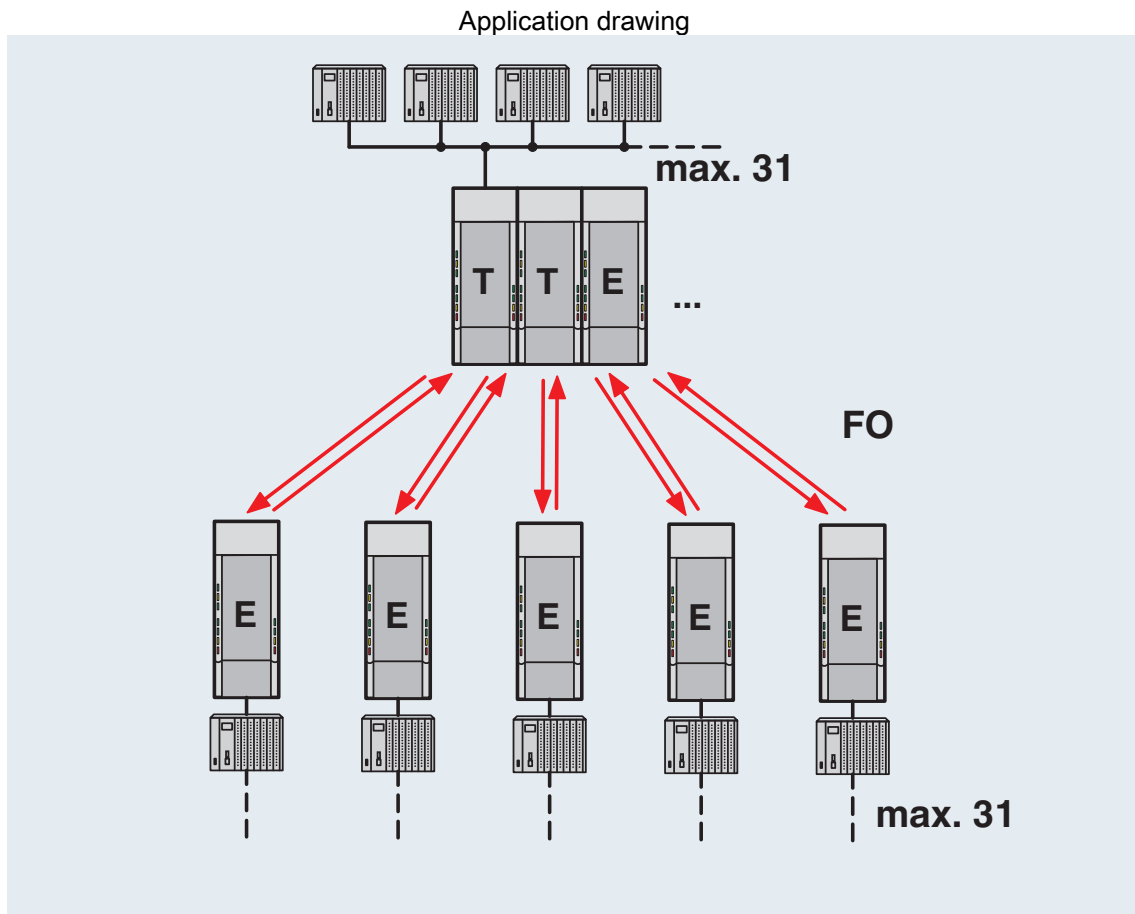

Star structure

PSI-MOS-PROFIB/FO1300 T - FO converters

2708892

<https://www.phoenixcontact.com/in/products/2708892>

Schematic diagram

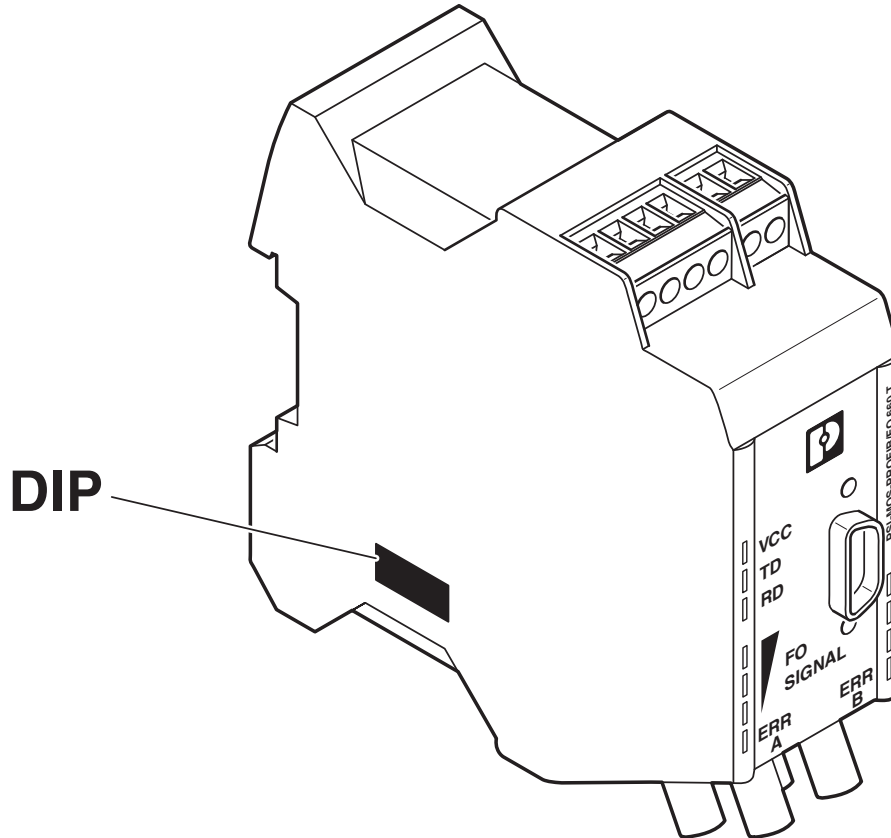

Position of DIP switches

Application drawing

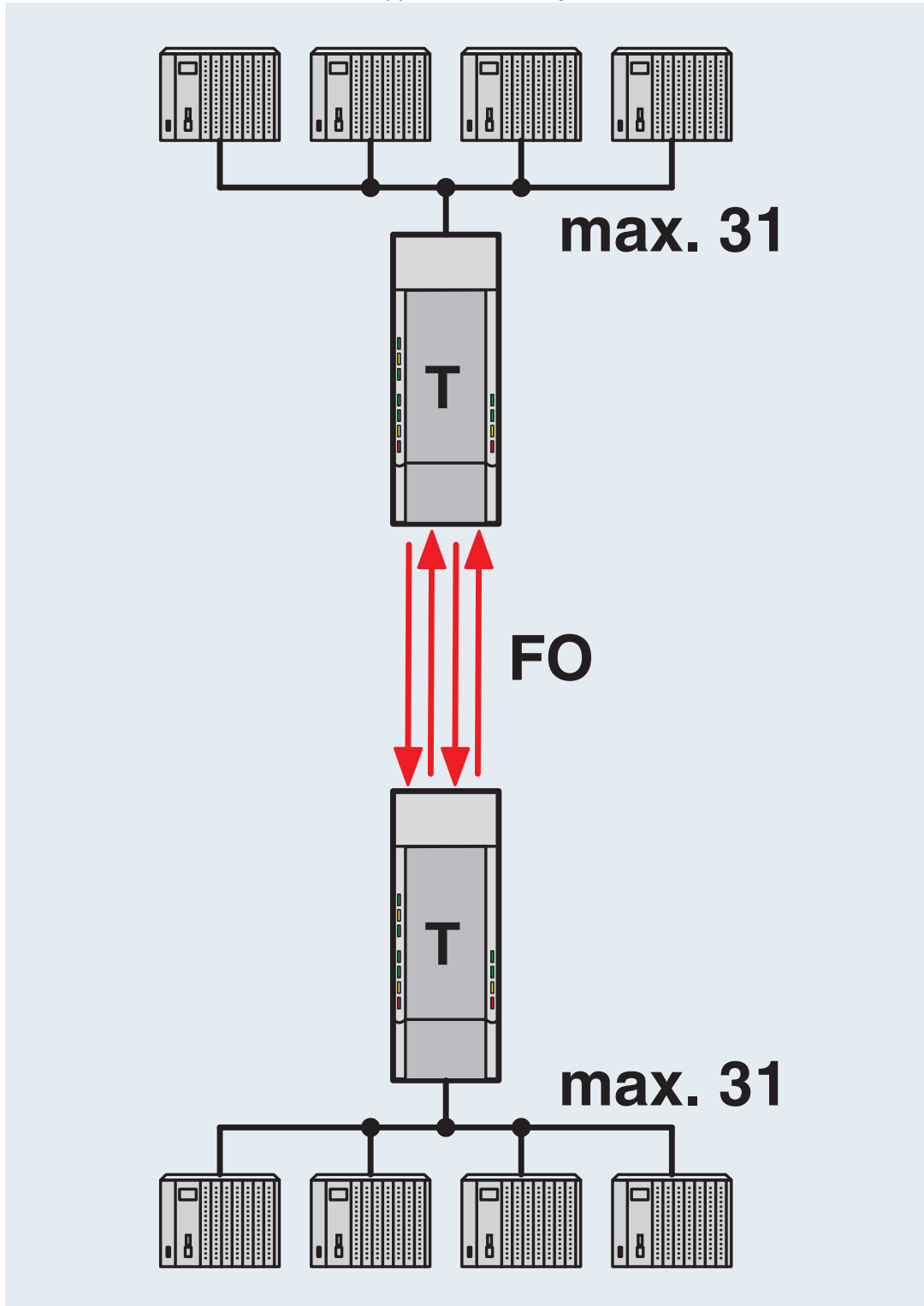

Redundant point-to-point connection

PSI-MOS-PROFIB/FO1300 T - FO converters



2708892

<https://www.phoenixcontact.com/in/products/2708892>

Dimensional drawing

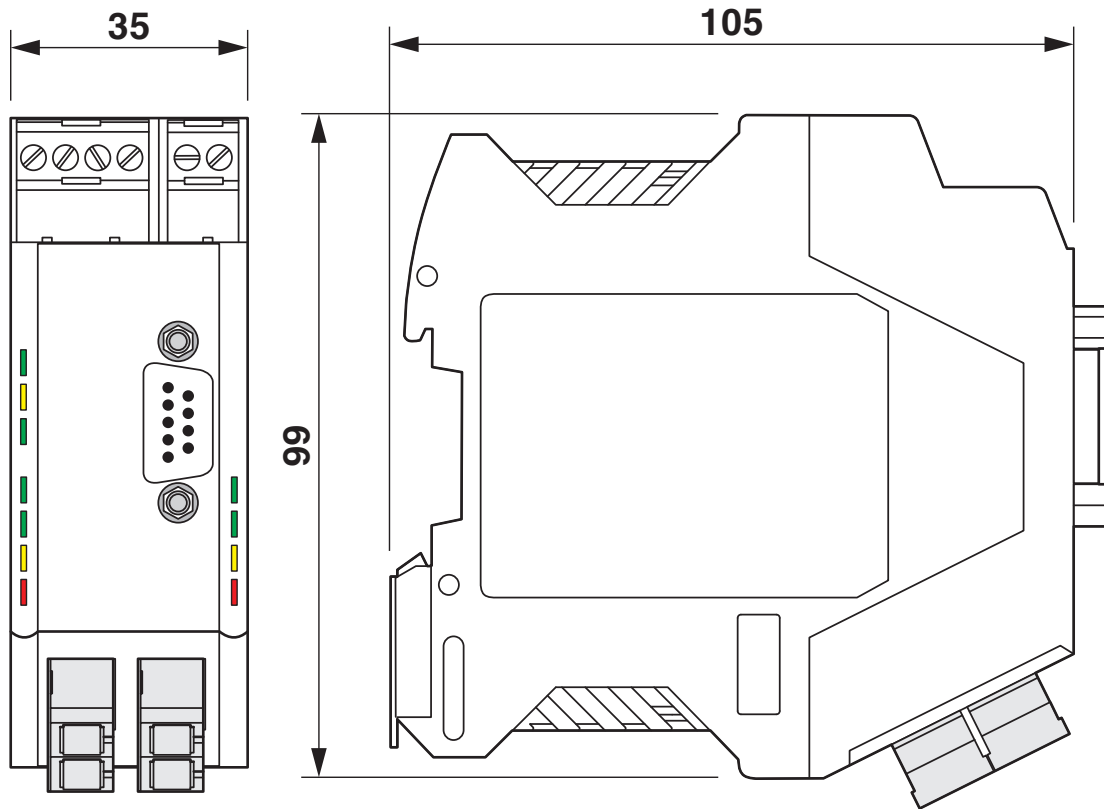

Housing dimensions

PSI-MOS-PROFIB/FO1300 T - FO converters



2708892

<https://www.phoenixcontact.com/in/products/2708892>

Application drawing

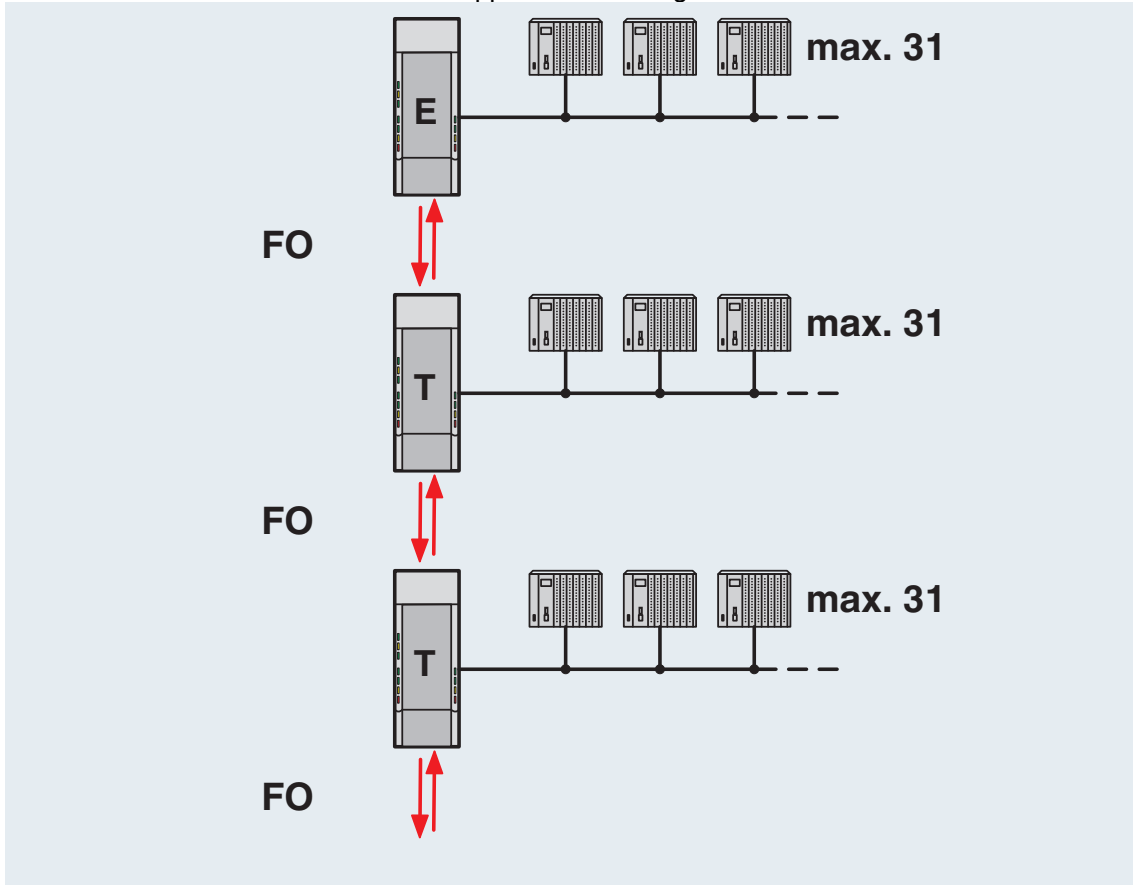

Line structure

Block diagram

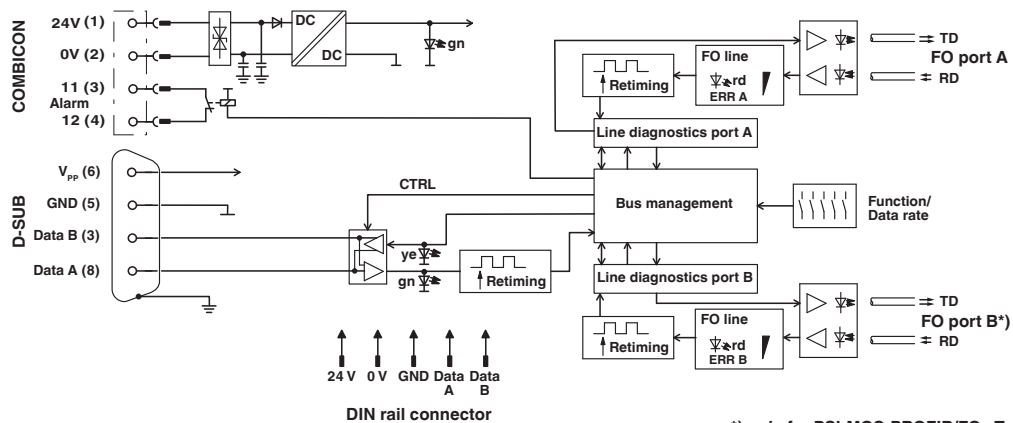

*) only for PSI-MOS-PROFIB/FO...T

*) only with PSI-MOS.../FO...T

Application drawing

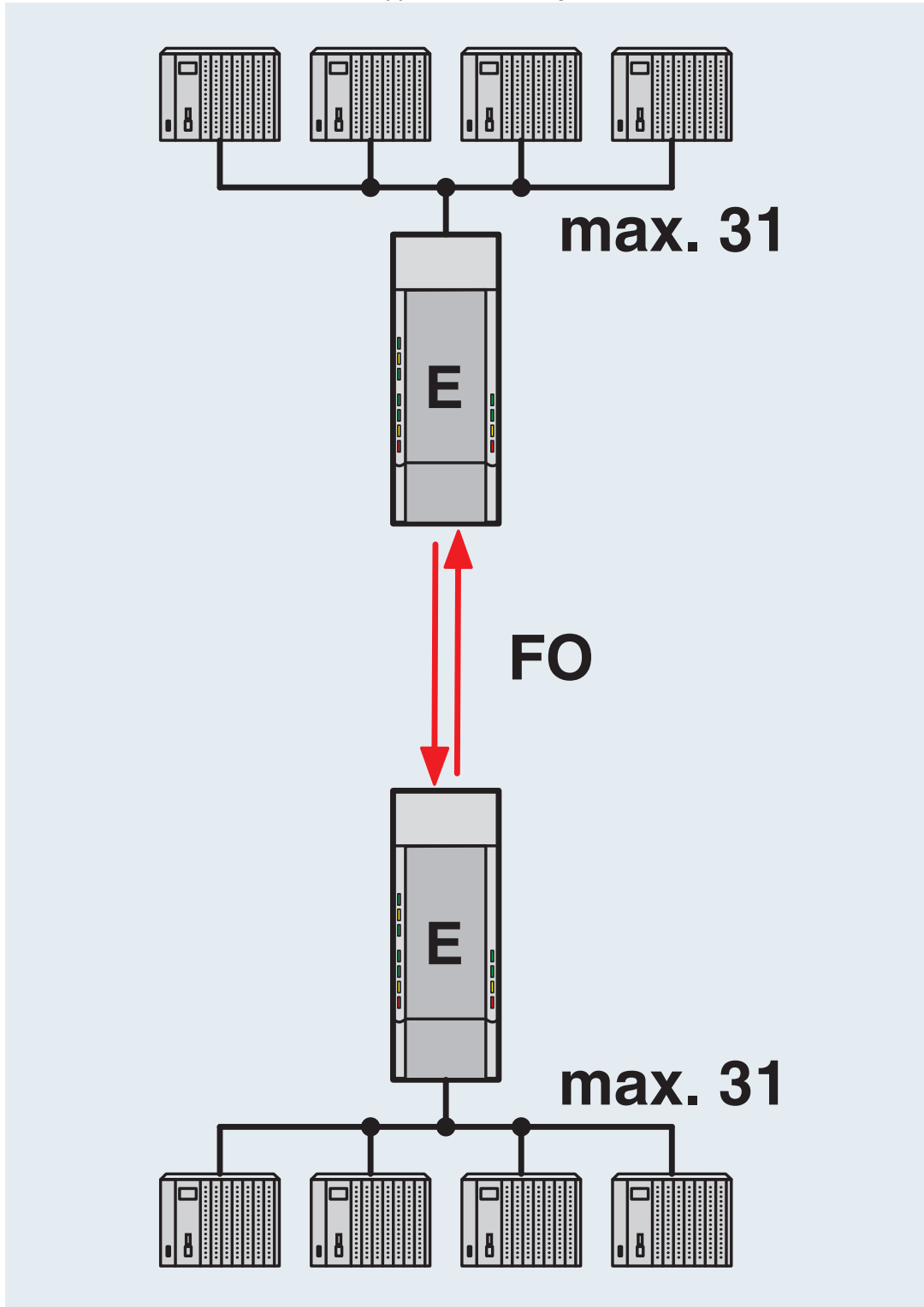

Point-to-point connection

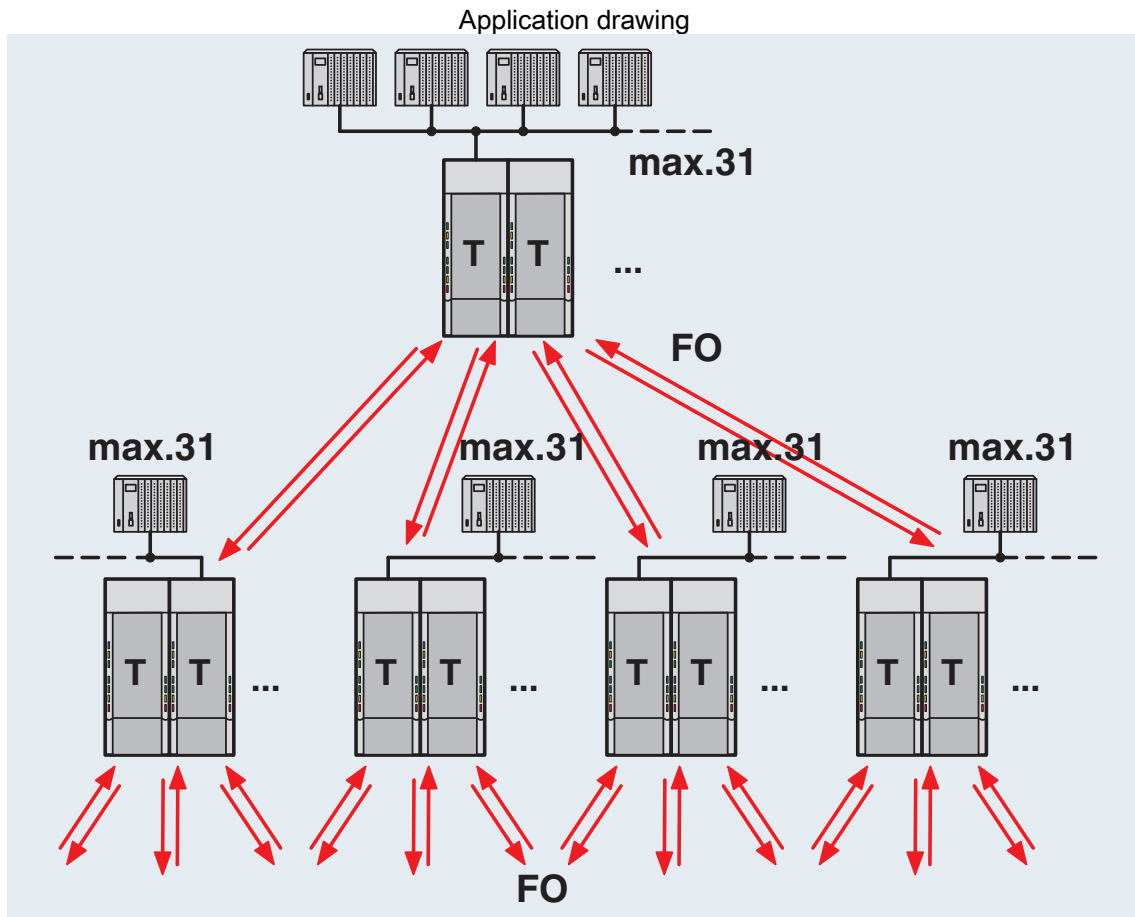

Tree structure

PSI-MOS-PROFIB/FO1300 T - FO converters



2708892

<https://www.phoenixcontact.com/in/products/2708892>

Application drawing

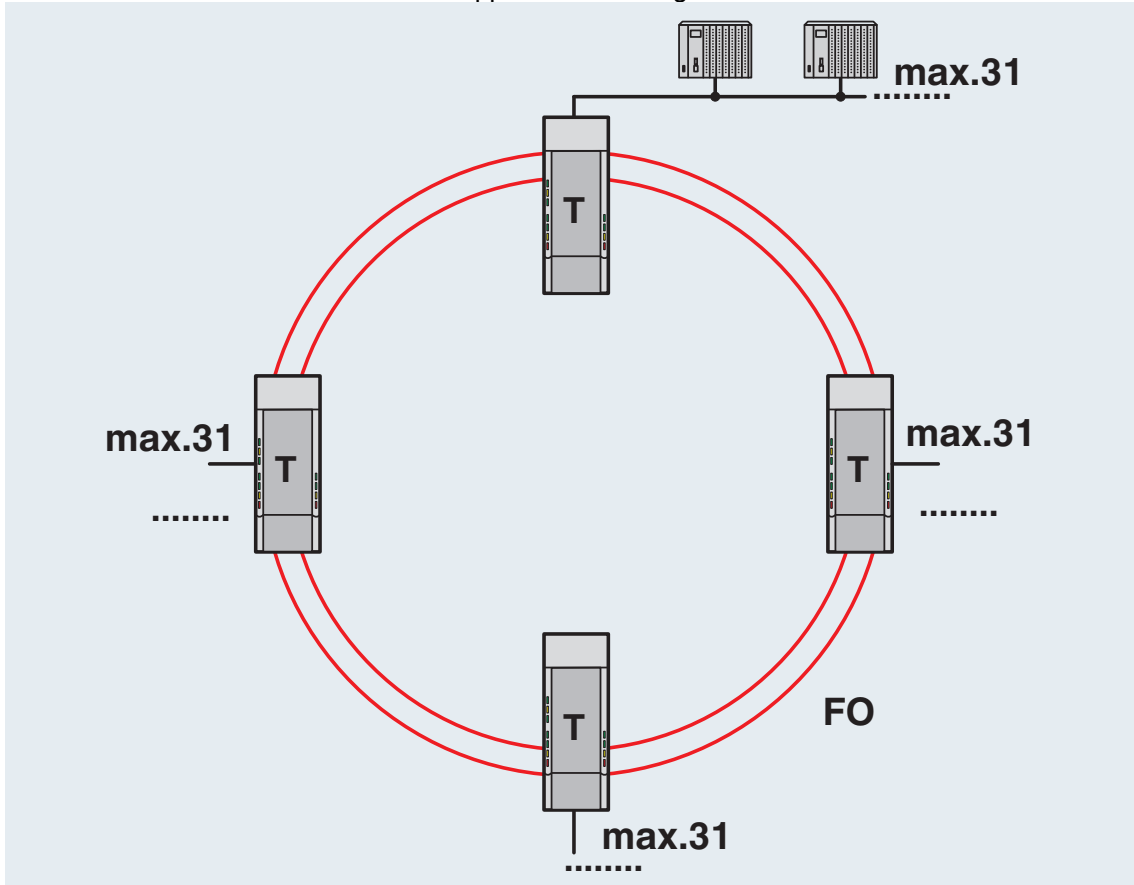

Redundant FO ring

PSI-MOS-PROFIB/FO1300 T - FO converters



2708892

<https://www.phoenixcontact.com/in/products/2708892>

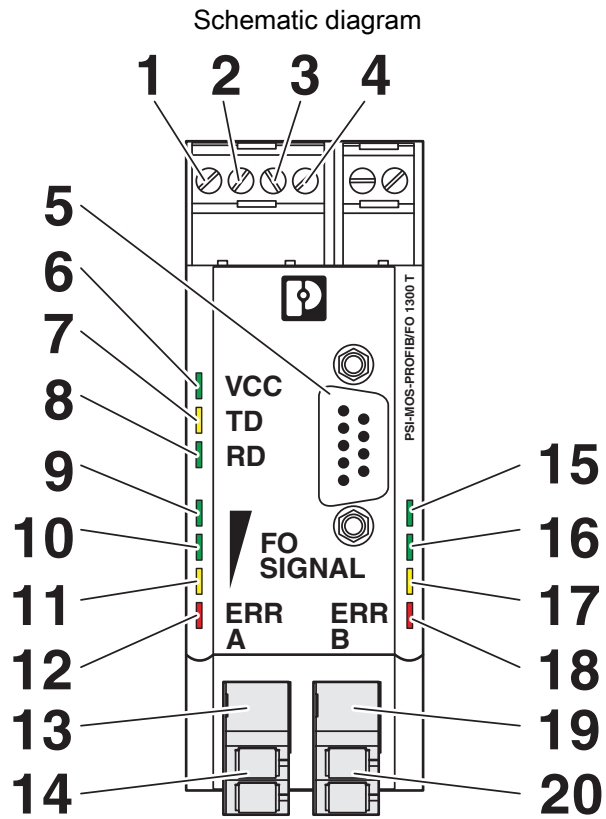

Front view

2708892

<https://www.phoenixcontact.com/in/products/2708892>

Approvals



EAC

Approval ID: TR TS_D_01871-19



UL Listed

Approval ID: FILE E 238705



cUL Listed

Approval ID: FILE E 238705



KC

Approval ID: MSIP-REI-PCK-2708892



EAC

Approval ID: TR TS_D_01871-19



cUL Listed

Approval ID: FILE E 238705



UL Listed

Approval ID: FILE E 238705



KC

Approval ID: MSIP-REI-PCK-2708892



ATEX

Approval ID: PxCIF07ATEX2708559X



IECEx

Approval ID: IECEx ULD 21.0013X



cUL Listed

Approval ID: FILE E 199827



UL Listed

Approval ID: FILE E 199827

PSI-MOS-PROFIB/FO1300 T - FO converters



2708892

<https://www.phoenixcontact.com/in/products/2708892>



ATEX

Approval ID: UL 21 ATEX 2550X



UL Listed

Approval ID: FILE E 199827



cUL Listed

Approval ID: FILE E 199827



IECEX

Approval ID: IECEX ULD 21.0013X



ATEX

Approval ID: UL 21 ATEX 2550X



ATEX

Approval ID: PxCIF07ATEX2708559X

PSI-MOS-PROFIB/FO1300 T - FO converters



2708892

<https://www.phoenixcontact.com/in/products/2708892>

Classifications

ECLASS

ECLASS-11.0	19170411
ECLASS-12.0	19170411
ECLASS-13.0	19170411

ETIM

ETIM 8.0	EC001467
----------	----------

UNSPSC

UNSPSC 21.0	43201500
-------------	----------

PSI-MOS-PROFIB/FO1300 T - FO converters



2708892

<https://www.phoenixcontact.com/in/products/2708892>

Environmental Product Compliance

China RoHS	Environmentally Friendly Use Period = 50 years For information on hazardous substances, refer to the manufacturer's declaration available under "Downloads"
------------	--

2708892

<https://www.phoenixcontact.com/in/products/2708892>

Accessories

FOC-LC:PA-SC:PA-OM2:D01/1 - FO patch cable

1115607

<https://www.phoenixcontact.com/in/products/1115607>

Multi-mode OM2 duplex jumper, LC-SC, UPC polishing, length 1 m

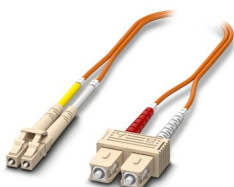

FOC-LC:PA-SC:PA-OM2:D01/2 - FO patch cable

1115605

<https://www.phoenixcontact.com/in/products/1115605>

Multi-mode OM2 duplex jumper, LC-SC, UPC polishing, length 2 m

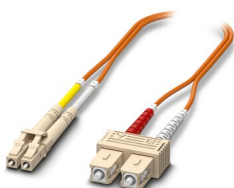

PSI-MOS-PROFIB/FO1300 T - FO converters

2708892

<https://www.phoenixcontact.com/in/products/2708892>

FOC-SC:PA-SC:PA-OM2:D01/1 - FO patch cable

1115536

<https://www.phoenixcontact.com/in/products/1115536>

Multi-mode OM2 duplex jumper, SC-SC, UPC polishing, length 1 m

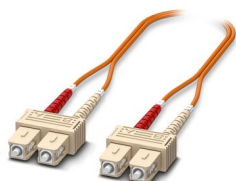

FOC-SC:PA-SC:PA-OM2:D01/2 - FO patch cable

1115535

<https://www.phoenixcontact.com/in/products/1115535>

Multi-mode OM2 duplex jumper, SC-SC, UPC polishing, length 2 m

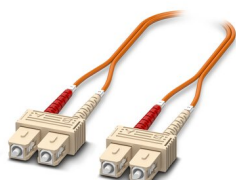

PSI-MOS-PROFIB/FO1300 T - FO converters



2708892

<https://www.phoenixcontact.com/in/products/2708892>

FOC-ST:PA-SC:PA-OM2:D01/1 - FO patch cable

1115574

<https://www.phoenixcontact.com/in/products/1115574>

Multi-mode OM2 duplex jumper, ST-SC, UPC polishing, length 1 m

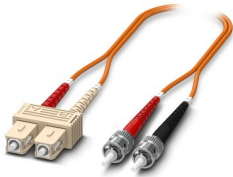

FOC-ST:PA-SC:PA-OM2:D01/2 - FO patch cable

1115573

<https://www.phoenixcontact.com/in/products/1115573>

Multi-mode OM2 duplex jumper, ST-SC, UPC polishing, length 2 m

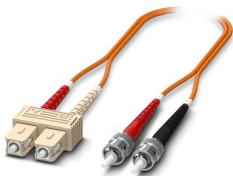

PSI-MOS-PROFIB/FO1300 T - FO converters

2708892

<https://www.phoenixcontact.com/in/products/2708892>

FOC-LC:PA-SC:PA-OM4:D01/1 - FO patch cable

1115601

<https://www.phoenixcontact.com/in/products/1115601>

Multi-mode OM4 duplex jumper, LC-SC, UPC polishing, length 1 m

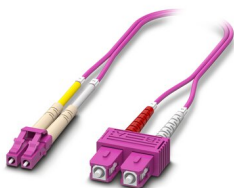

FOC-LC:PA-SC:PA-OM4:D01/2 - FO patch cable

1115600

<https://www.phoenixcontact.com/in/products/1115600>

Multi-mode OM4 duplex jumper, LC-SC, UPC polishing, length 2 m

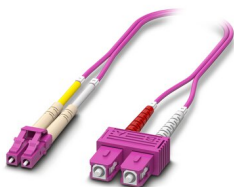

PSI-MOS-PROFIB/FO1300 T - FO converters

2708892

<https://www.phoenixcontact.com/in/products/2708892>

FOC-SC:PA-SC:PA-OM4:D01/1 - FO patch cable

1115424

<https://www.phoenixcontact.com/in/products/1115424>

Multi-mode OM4 duplex jumper, SC-SC, UPC polishing, length 1 m

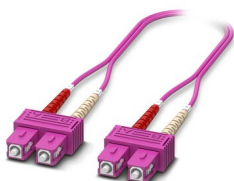

FOC-SC:PA-SC:PA-OM4:D01/2 - FO patch cable

1115423

<https://www.phoenixcontact.com/in/products/1115423>

Multi-mode OM4 duplex jumper, SC-SC, UPC polishing, length 2 m

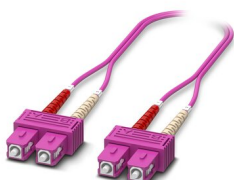

PSI-MOS-PROFIB/FO1300 T - FO converters



2708892

<https://www.phoenixcontact.com/in/products/2708892>

QUINT4-SYS-PS/1AC/24DC/2.5/SC - Power supply unit

2904614

<https://www.phoenixcontact.com/in/products/2904614>



Primary-switched power supply, QUINT POWER, screw connection, DIN rail mounting, supply of devices possible via the TBUS DIN rail connector, protective coating, input: single-phase, output: 24 V DC/2.5 A

ME 17,5 TBUS 1,5/ 5-ST-3,81 KMGY - DIN rail bus connectors

2713645

<https://www.phoenixcontact.com/in/products/2713645>

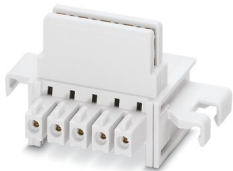

DIN rail connector, color: light grey, nominal current: 8 A (parallel contacts), rated voltage (III/2): 125 V, number of positions: 5, pitch: 3.81 mm, mounting: DIN rail mounting, locking: without, mounting: without, type of packaging: packed in cardboard, Item with gold-plated contacts, bus connectors for connecting with electronics housings, 5 parallel contacts

PSI-MOS-PROFIB/FO1300 T - FO converters

2708892

<https://www.phoenixcontact.com/in/products/2708892>

FOC-SC:PA-SC:PA-OS2:D01/1 - FO patch cable

1115550

<https://www.phoenixcontact.com/in/products/1115550>

Single-mode OS2 duplex jumper, SC-SC, UPC polishing, length 1 m

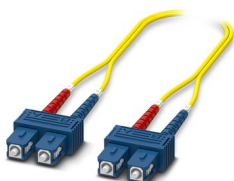

FOC-SC:PA-SC:PA-OS2:D01/2 - FO patch cable

1115548

<https://www.phoenixcontact.com/in/products/1115548>

Single-mode OS2 duplex jumper, SC-SC, UPC polishing, length 2 m

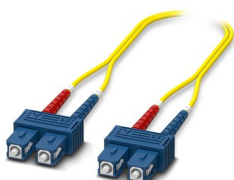

PSI-MOS-PROFIB/FO1300 T - FO converters

2708892

<https://www.phoenixcontact.com/in/products/2708892>

FOC-ST:PA-SC:PA-OS2:D01/1 - FO patch cable

1115582

<https://www.phoenixcontact.com/in/products/1115582>

Single-mode OS2 duplex jumper, ST-SC, UPC polishing, length 1 m

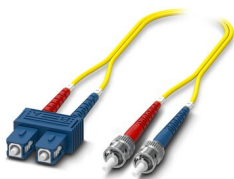

FOC-ST:PA-SC:PA-OS2:D01/2 - FO patch cable

1115581

<https://www.phoenixcontact.com/in/products/1115581>

Single-mode OS2 duplex jumper, ST-SC, UPC polishing, length 2 m

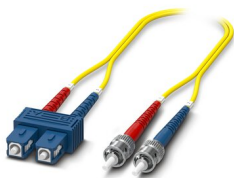

PSI-MOS-PROFIB/FO1300 T - FO converters

2708892

<https://www.phoenixcontact.com/in/products/2708892>

FOC-LC:PA-SC:PA-OS2:D01/1 - FO patch cable

1115618

<https://www.phoenixcontact.com/in/products/1115618>

Single-mode OS2 duplex jumper, LC-SC, UPC polishing, length 1 m

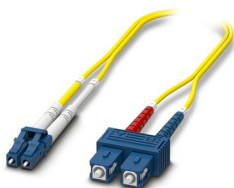

FOC-LC:PA-SC:PA-OS2:D01/2 - FO patch cable

1115617

<https://www.phoenixcontact.com/in/products/1115617>

Single-mode OS2 duplex jumper, LC-SC, UPC polishing, length 2 m

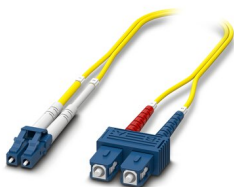

2708892

<https://www.phoenixcontact.com/in/products/2708892>

FOC-GDM-RUGGED-1016/IP20/... - FO patch cable

2901558

<https://www.phoenixcontact.com/in/products/2901558>

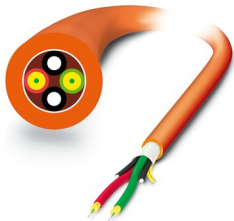

Robust GOF installation cable for assembly (IP20 heads only) for installation in stationary systems and machines, aramid strain-relief elements, with individual elements made from FRNC material, halogen-free, ozone and UV resistant, with a polyurethane (PUR) outer sheath

FOC-GDO-1017/IP20/... - FO patch cable

2901559

<https://www.phoenixcontact.com/in/products/2901559>



Highly rugged GOF round cable (IP20 heads only) for assembly and for outdoor installation with integrated moisture barrier as well as rodent-proof scrim. Individual elements made from highly flexible FRNC material. The wire is ozone and UV resistant with a very rugged polyethylene outer sheath.

PSI-MOS-PROFIB/FO1300 T - FO converters

2708892

<https://www.phoenixcontact.com/in/products/2708892>

PSM-LWL-GDO- 50/125 - FO cable

2799432

<https://www.phoenixcontact.com/in/products/2799432>



Fiberglass cable, duplex 50/125 μm , by the meter, without connector, for outdoor installation

PSM-LWL-GDM-RUGGED- 50/125 - FO cable

2799322

<https://www.phoenixcontact.com/in/products/2799322>



Fiber glass cable, duplex 50 μm /125 μm , by the meter, without male connector, for installation in stationary systems and machines

PSI-MOS-PROFIB/FO1300 T - FO converters



2708892

<https://www.phoenixcontact.com/in/products/2708892>

SUBCON-PLUS-PROFIB/90/PG/SC - D-SUB bus connector

2313708

<https://www.phoenixcontact.com/in/products/2313708>



D-SUB connector, 9-pos., male connector, 90° cable entry, bus system: PROFIBUS DP up to 12 Mbps with PG D-SUB socket for connecting a programming device, termination resistor can be switched on via slide switch, pin assignment: 3, 5, 6, 8; screw connection terminal blocks

SUBCON-PLUS-PROFIB/90/PG/IDC - D-SUB bus connector

2313685

<https://www.phoenixcontact.com/in/products/2313685>



D-SUB connector, 9-pos., male connector, 90° cable entry, bus system: PROFIBUS DP up to 12 Mbps with PG D-SUB socket for connecting a programming device, termination resistor can be switched on via slide switch, pin assignment: 3, 5, 6, 8; IDC terminal block connection

PSI-MOS-PROFIB/FO1300 T - FO converters



2708892

<https://www.phoenixcontact.com/in/products/2708892>

SUBCON-PLUS-PROFIB/AX/M12 - D-SUB bus connector

2902321

<https://www.phoenixcontact.com/in/products/2902321>



D-SUB plug, 9-pos., pin, assignment: 3, 5, 6, 8; two M12 cable glands (B-coded) under 180° (axial). Bus system: PROFIBUS DP up to 12 Mbps. Termination resistor via separate M12 terminator.

SUBCON-PLUS-PROFIB/90X/M12 - D-SUB bus connector

2902729

<https://www.phoenixcontact.com/in/products/2902729>



D-SUB plug, 9-pos., pin, assignment: 3, 5, 6, 8; two 90° cable entries M12 (B-coded). Bus system: PROFIBUS DP up to 12 Mbps. Termination resistor via separate M12 terminator. Long version; S7-compatible.

PSI-MOS-PROFIB/FO1300 T - FO converters



2708892

<https://www.phoenixcontact.com/in/products/2708892>

SUBCON-PLUS-PROFIB/90/M12 - D-SUB bus connector

2902318

<https://www.phoenixcontact.com/in/products/2902318>



D-SUB plug, 9-pos., pin, assignment: 3, 5, 6, 8; two 90° M12 cable glands (B-coded). Bus system: PROFIBUS DP up to 12 Mbps. Termination resistor via separate M12 terminator.

SUBCON-PLUS-PROFIB/35/M12 - D-SUB bus connector

2902320

<https://www.phoenixcontact.com/in/products/2902320>



D-SUB plug, 9-pos., pin, assignment: 3, 5, 6, 8; two 35° cable entries M12 (B-coded). Bus system: PROFIBUS DP up to 12 Mbps. Termination resistor via separate M12 terminator.

PSI-MOS-PROFIB/FO1300 T - FO converters



2708892

<https://www.phoenixcontact.com/in/products/2708892>

PSI-TERMINATOR-PB-TBUS - Termination resistor

2702636

<https://www.phoenixcontact.com/in/products/2702636>



Active termination resistor for PROFIBUS and RS-485 bus systems, redundant power supply, routing of the supply voltage via DIN rail connector, electrical isolation, switchable termination, integrated programming interface

PSI-REP-PROFIBUS/12MB - Repeater

2708863

<https://www.phoenixcontact.com/in/products/2708863>



Modular repeater for electrical isolation and range increase for PROFIBUS up to 12 Mbps, 4-way isolation, rail-mountable, supply 24 V DC

Phoenix Contact 2023 © - all rights reserved
<https://www.phoenixcontact.com>

PHOENIX CONTACT (I) Pvt. Ltd.
A-58/2, Okhla Industrial Area, Phase - II, New Delhi-110 020

+91.1275.71420
info@phoenixcontact.co.in