

PSI-MOS-RS485W2/FO 850 E - FO converters



2708339

<https://www.phoenixcontact.com/in/products/2708339>

Please be informed that the data shown in this PDF document is generated from our Online Catalog. Please find the complete data in the user documentation. Our General Terms of Use for Downloads are valid.



FO converter with integrated optical diagnostics, alarm contact, for RS-485 2-wire bus systems (SUCONET K, Modbus ...) up to 500 kbps, NRZ coding, terminal device with one FO interface (BFOC), 850 nm, for PCF/fiberglass cable (multimode)

Product Description

The **PSI-MOS-RS485W2/FO...** FO converters convert the electrical data signal into an optical one by protocol transparent means. The integrated optical diagnostics allow permanent monitoring of the FO paths during installation and also during operation. The floating switch contact is activated when the signal output on the fiber optic paths drops to a critical level. The **PSI-MOS-RS485W2/FO... E** termination devices convert an RS-485 interface to a fiber optic cable. They are ideal for point-to-point connections.

Your advantages

- Can be combined with the PSI copper repeater in a modular way using DIN rail connectors
- Supply voltage and data signals routed through the DIN rail connectors
- Connections can be plugged in via a COMBICON screw terminal block
- Automatic data rate detection or fixed data rate setting via DIP switches
- High-quality electrical isolation between all interfaces (RS-485 // fiber optic ports // power supply // DIN rail connector)
- Redundant power supply possible by means of optional system power supply unit
- Approved for use in zone 2
- Intrinsically safe fiber optic interface (Ex op is) for direct connection to devices in zone 1
- Integrated optical diagnostics for continuous monitoring of FO paths
- Floating switch contact for advance warning of critical FO paths
- Suitable for data rates up to 500 kbps
- Bit retiming for any cascading depth
- Shipbuilding approval in accordance with DNV GL

Commercial Data

Item number	2708339
Packing unit	1 pc
Minimum order quantity	1 pc
Sales Key	DNC
Product Key	DNC212
Catalog Page	Page 435 (C-6-2019)
GTIN	4017918974039
Weight per Piece (including packing)	235.8 g
Weight per Piece (excluding packing)	154.38 g

PSI-MOS-RS485W2/FO 850 E - FO converters



2708339

<https://www.phoenixcontact.com/in/products/2708339>

Customs tariff number	85176200
Country of origin	DE

Technical Data

Notes

Utilization restriction

EMC note	EMC: class A product, see manufacturer's declaration in the download area
----------	---

Utilization restriction

CCCex note	Use in potentially explosive areas is not permitted in China.
------------	---

Product properties

Product type	Media converter
MTTF	957 Years (SN 29500 standard, temperature 25°C, operating cycle 21%)
	426 Years (SN 29500 standard, temperature 40°C, operating cycle 34.25%)
	176 Years (SN 29500 standard, temperature 40°C, operating cycle 100%)
MTBF	272 Years (Telcordia standard, 25°C temperature, 21% operating cycle (5 days a week, 8 hours a day))
	44 Years (Telcordia standard, 40°C temperature, 34.25% operating cycle (5 days a week, 12 hours a day))

Electrical properties

Electrical isolation	VCC // RS-485
Maximum power dissipation for nominal condition	2.88 W
Test voltage data interface/power supply	1.5 kV _{rms} (50 Hz, 1 min.)

Supply

Supply voltage range	18 V DC ... 30 V DC (via pluggable COMBICON screw terminal block)
Nominal supply voltage	24 V DC (in acc. with UL)
Typical current consumption	120 mA (24 V DC)
Max. current consumption	130 mA
	≤ 2 A (For operation in a joining station, via the DIN rail connector)
Connection method	COMBICON plug-in screw terminal block

Output data

Switching

Output name	Relay output
Output description	Alarm output
Number of outputs	1
Maximum switching voltage	60 V DC (Resistive Load, General Load)
	30 V AC (Resistive load)
	42 V AC (peak, resistive load)

Limiting continuous current	0.46 A
-----------------------------	--------

Connection data

Supply

Connection method	COMBICON plug-in screw terminal block
Stripping length	7 mm
Tightening torque	0.56 Nm ... 0.79 Nm

Interfaces

Bit distortion, input	± 35 % (permitted)
Bit distortion, output	< 6.25 %
Bit delay	≤ 1 bit
Signal	Modbus
	S-BUS
	Suconet K
	J-BUS
	DATA HIGHWAY

Data: optical FO

No. of channels	1
Transmit capacity, minimum	-4 dBm (200/230 μm)
	-17.6 dBm (50/125 μm)
	-14 dBm (62,5/125 μm)
Transmission length incl. 3 dB system reserve	2800 m (with F-K 200/230 8 dB/km with quick mounting connector)
	4200 m (with F-G 50/125 2.5 dB/km)
	3300 m (with F-G 62,5/125 3.0 dB/km)
Transmission protocol	Protocol-transparent to the RS-485 interface
Connection method	B-FOC (ST®)
Wavelength	850 nm
Minimum receiver sensitivity	-32.5 dBm (50/125 μm)
	-32.5 dBm (62,5/125 μm)
	-32.1 dBm (200/230 μm)
Maximum receiver sensitivity	-3 dBm (200/230 μm)
Transmission medium	PCF fiber
	Multi-mode fiberglass

Data: RS-485 interface, 2-wire

Serial transmission speed	4.8/ 9.6/ 19.2/ 38.4/ 57.6/ 75/ 93.75/ 115.2/ 136/ 187.5/ 375/ 500 kbps
Connection method	Pluggable screw connection
Transmission length	≤ 1200 m (depending on the data rate, with shielded, twisted data cable)
Termination resistor	390 Ω (Can be connected)
	220 Ω

PSI-MOS-RS485W2/FO 850 E - FO converters



2708339

<https://www.phoenixcontact.com/in/products/2708339>

	390 Ω
Conductor cross section flexible max.	2.5 mm ²
Conductor cross section flexible min.	0.2 mm ²
Conductor cross section, rigid max.	2.5 mm ²
Conductor cross section, rigid min.	0.2 mm ²
Max. AWG conductor cross section, flexible	14
Min. AWG conductor cross section, flexible	24
Single-wire/terminal point, rigid AWG max.	14
Single-wire/terminal point, rigid AWG min.	24
Transmission medium	Copper
File format/coding	UART (11/10 bit switchable; NRZ), slip-tolerant
Data direction switching	Automatic control

Dimensions

Width	35 mm
Height	99 mm
Depth	105 mm

Material specifications

Material Housing	PA 6.6-FR
------------------	-----------

Cable/line

FO cable

Fiber types	200/230 μm
	50/125 μm
	62.5/125 μm
	PCF fiber
	Fiberglass

Environmental and real-life conditions

Ambient conditions

Degree of protection	IP20
Ambient temperature (operation)	-20 °C ... 60 °C
Ambient temperature (storage/transport)	-40 °C ... 85 °C
Altitude	≤ 5000 m (For restrictions, see the manufacturer's declaration for altitude operation)
	≤ 2000 m (Hazardous locations)
Permissible humidity (operation)	30 % ... 95 % (non-condensing)

Approvals

CE

Certificate	CE-compliant
-------------	--------------

ATEX

PSI-MOS-RS485W2/FO 850 E - FO converters



2708339

<https://www.phoenixcontact.com/in/products/2708339>

Identification	<input type="checkbox"/> II 3 G Ex ec IIC T4 Gc
Certificate	UL 21 ATEX 2550X
Note	Please follow the special installation instructions in the documentation!

ATEX, FO interface

Identification	<input type="checkbox"/> II (2) G [Ex op is Gb] IIC <input type="checkbox"/> II (2) D [Ex op is Db] IIIC
Certificate	PTB 06 ATEX 2042 U
Note	Please follow the special installation instructions in the documentation!

IECEX

Identification	Ex ec IIC T4 Gc
Certificate	IECEX ULD 21.00013X

UL, USA/Canada

Identification	Class I, Zone 2, AEx ec IIC T4 Gc Ex ec IIC T4 Gc X Class I, Div. 2, Groups A, B, C, D
----------------	--

KC approval for South Korea

Certificate	KCC-REI-PCK-FOCVT2708339
-------------	--------------------------

Corrosive gas test

Identification	ISA-S71.04-1985 G3 Harsh Group A
----------------	----------------------------------

Shipbuilding

Identification	DNV GL
----------------	--------

DNV GL data

Temperature	B
Humidity	A
Vibration	A
EMC	B
Enclosure	Required protection according to the Rules shall be provided upon installation on board

EMC data

Noise immunity	EN 61000-6-2:2005
Electromagnetic compatibility	Conformance with EMC Directive 2014/30/EU
Noise emission	EN 55011

Electrostatic discharge

Standards/regulations	EN 61000-4-2
-----------------------	--------------

Electrostatic discharge

Contact discharge	± 6 kV
Discharge in air	± 8 kV

PSI-MOS-RS485W2/FO 850 E - FO converters



2708339

<https://www.phoenixcontact.com/in/products/2708339>

Comments	Criterion B
Electromagnetic HF field	
Standards/regulations	EN 61000-4-3
Electromagnetic HF field	
Field intensity	10 V/m
Comments	Criterion A
Fast transients (burst)	
Standards/regulations	EN 61000-4-4
Fast transients (burst)	
Input	± 2 kV
Signal	± 2 kV
Comments	Criterion B
Surge current load (surge)	
Standards/regulations	EN 61000-4-5
Surge current load (surge)	
Input	± 0.5 kV
Signal	± 1 kV
Comments	Criterion B
Conducted interference	
Standards/regulations	EN 61000-4-6
Conducted interference	
Comments	Criterion A
Voltage	10 V
Emitted interference	
Standards/regulations	EN 55011
Comments	Class A, industrial applications
Criteria	
Criterion A	Normal operating behavior within the specified limits.
Criterion B	Temporary impairment to operational behavior that is corrected by the device itself.

Standards and regulations

Free from substances that could impair the application of coating	in accordance with VW-AUDI-Seat central standard P-VW 3.10.7 57 65 0
---	--

Mounting

Mounting type	DIN rail mounting
---------------	-------------------

Drawings

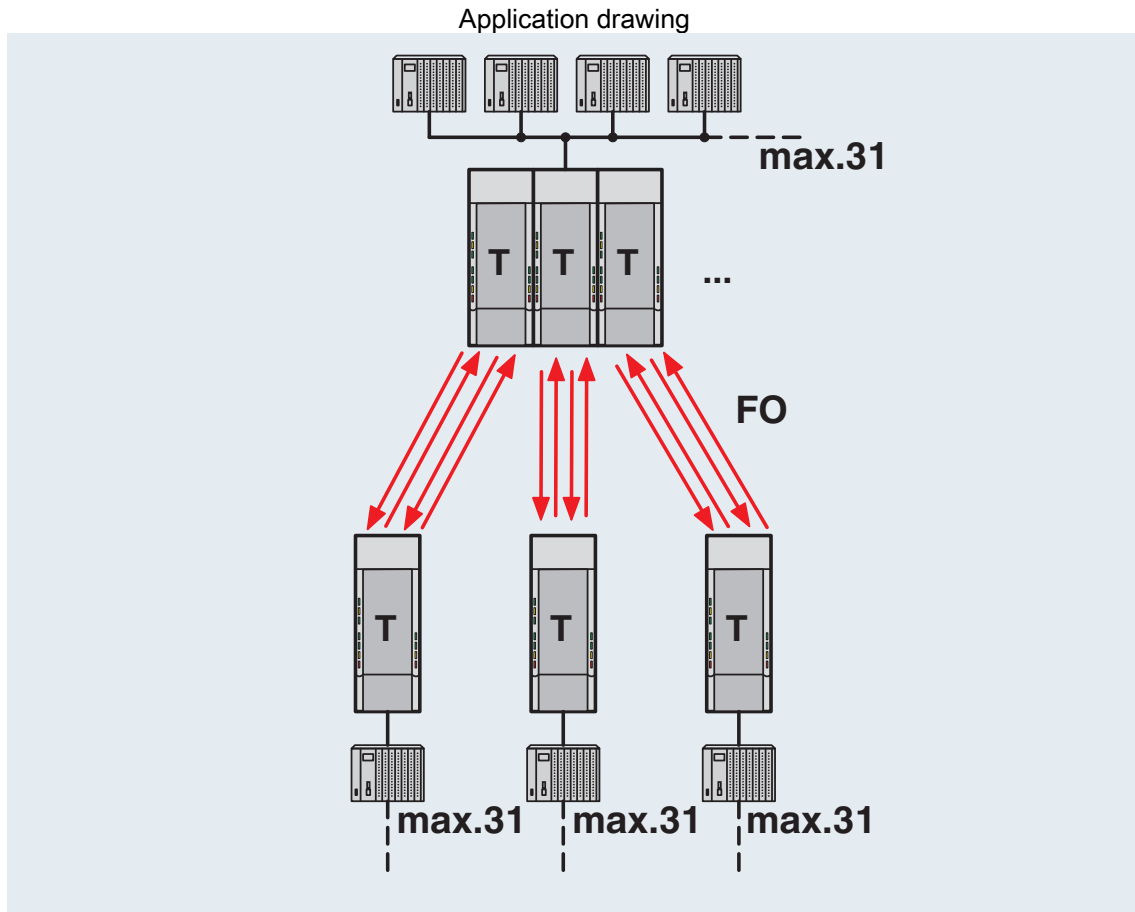

Redundant structure

PSI-MOS-RS485W2/FO 850 E - FO converters

2708339

<https://www.phoenixcontact.com/in/products/2708339>

Schematic diagram

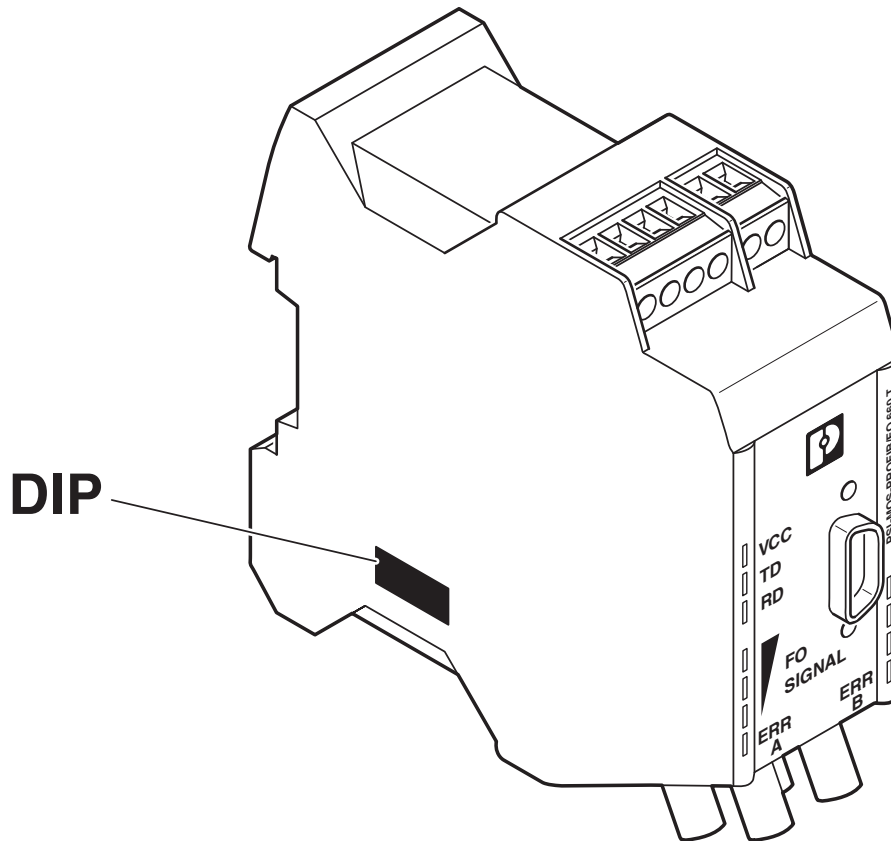

Position of DIP switches

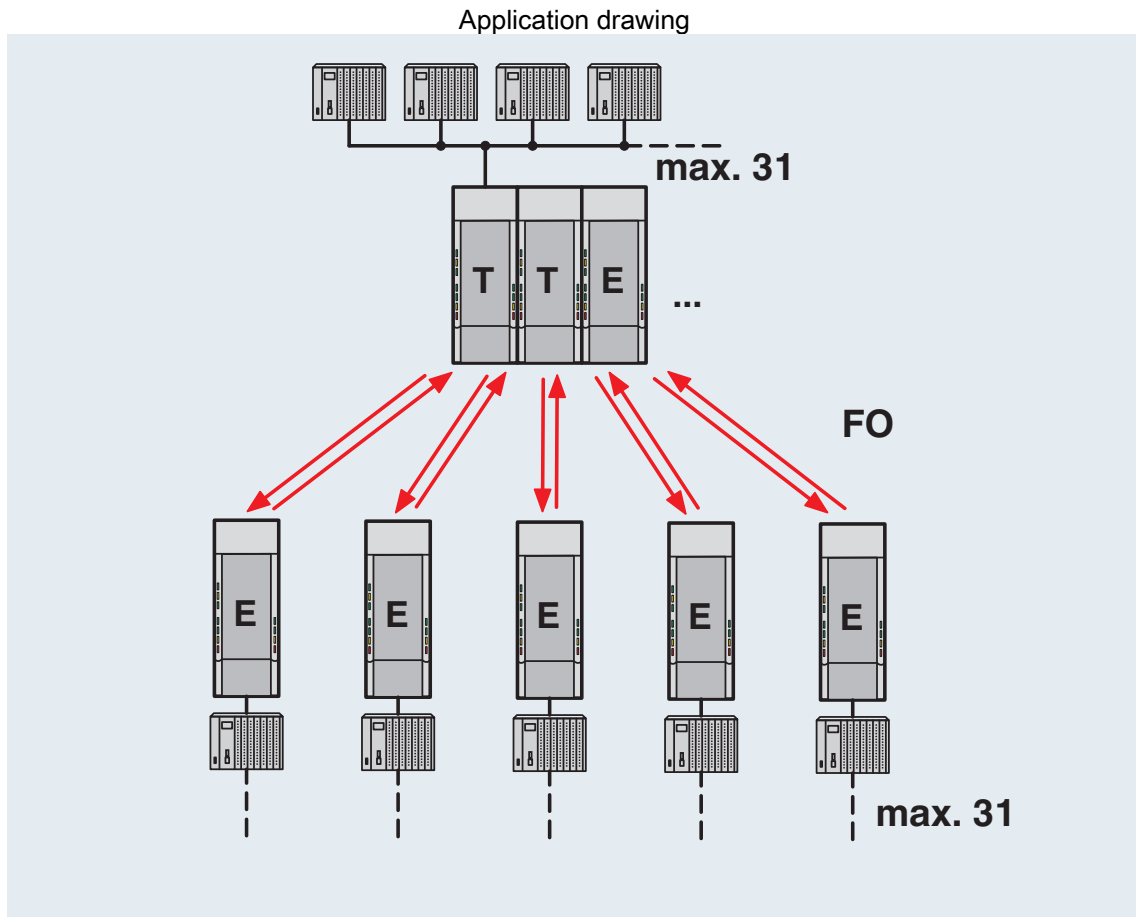

Star structure

Application drawing

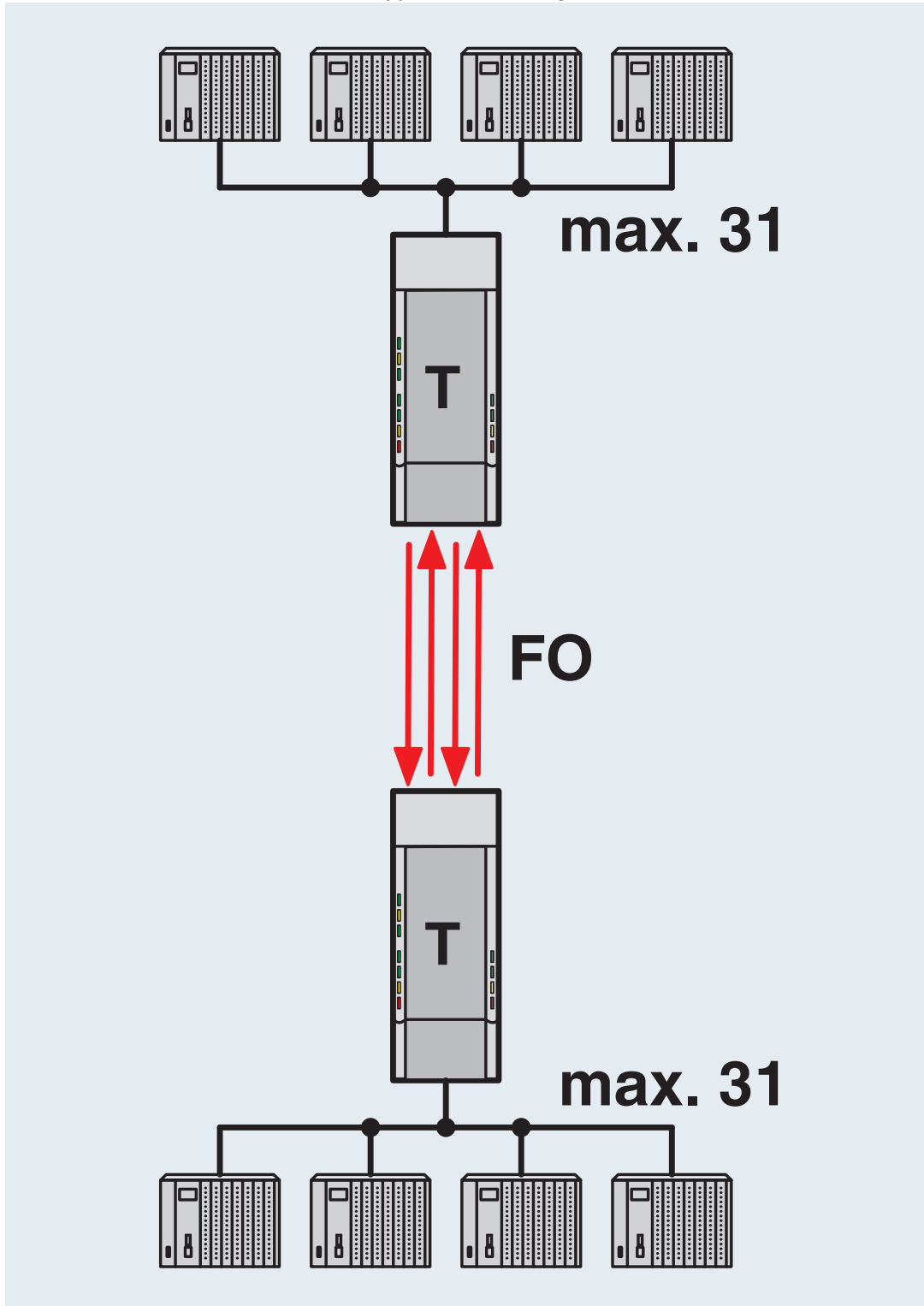

Redundant point-to-point connection

PSI-MOS-RS485W2/FO 850 E - FO converters



2708339

<https://www.phoenixcontact.com/in/products/2708339>

Block diagram

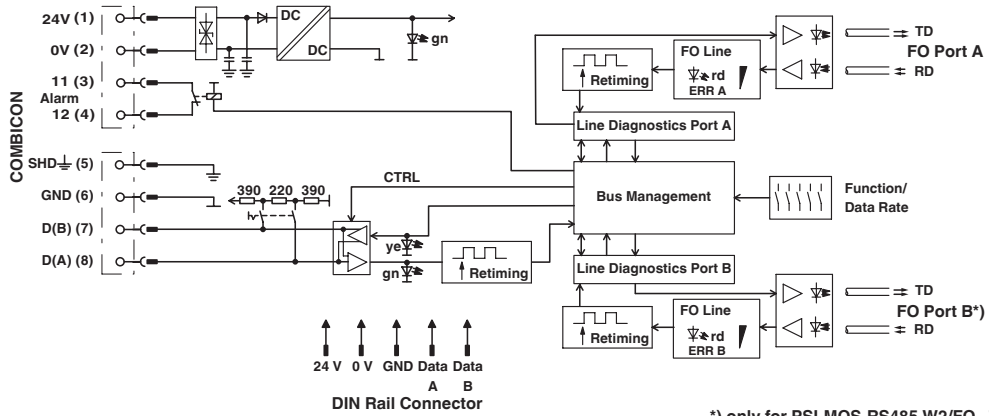

*) only for PSI-MOS-RS485 W2/FO...T

*) only with PSI-MOS.../FO...T

Application drawing

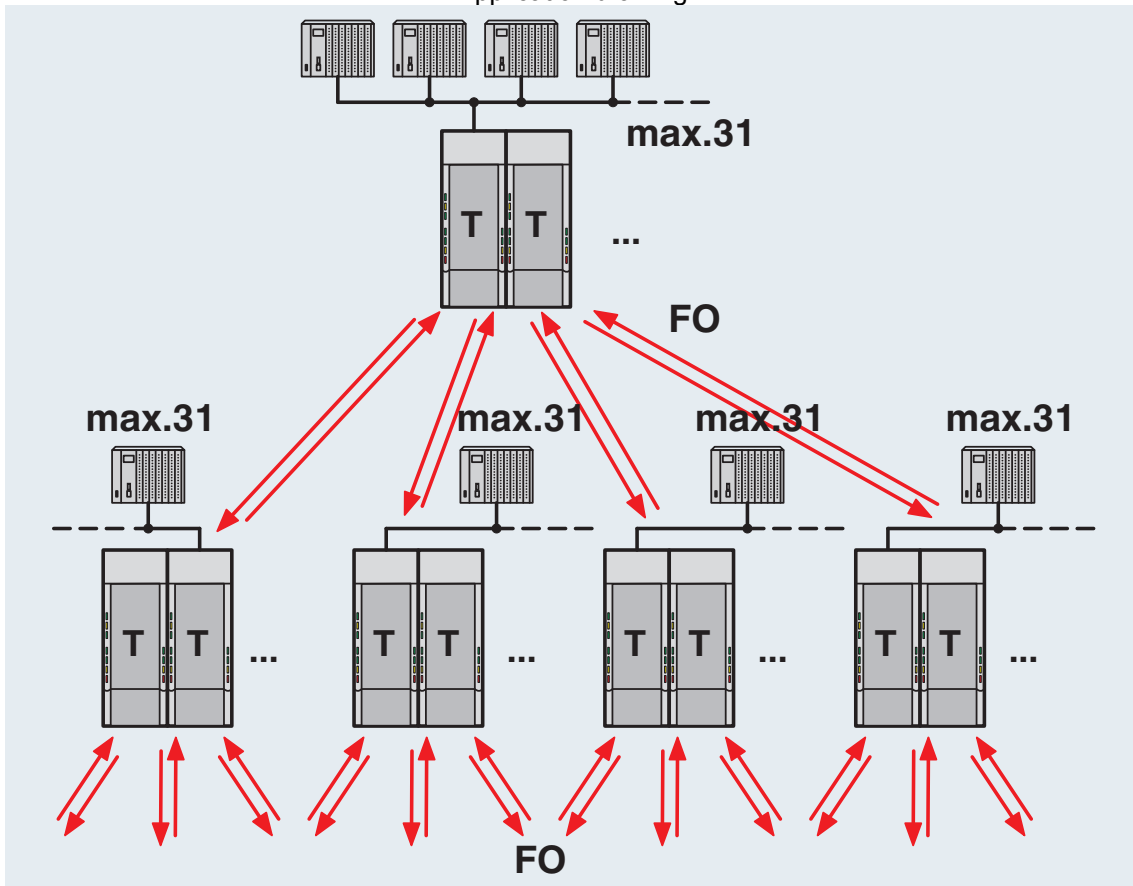

Tree structure

Application drawing

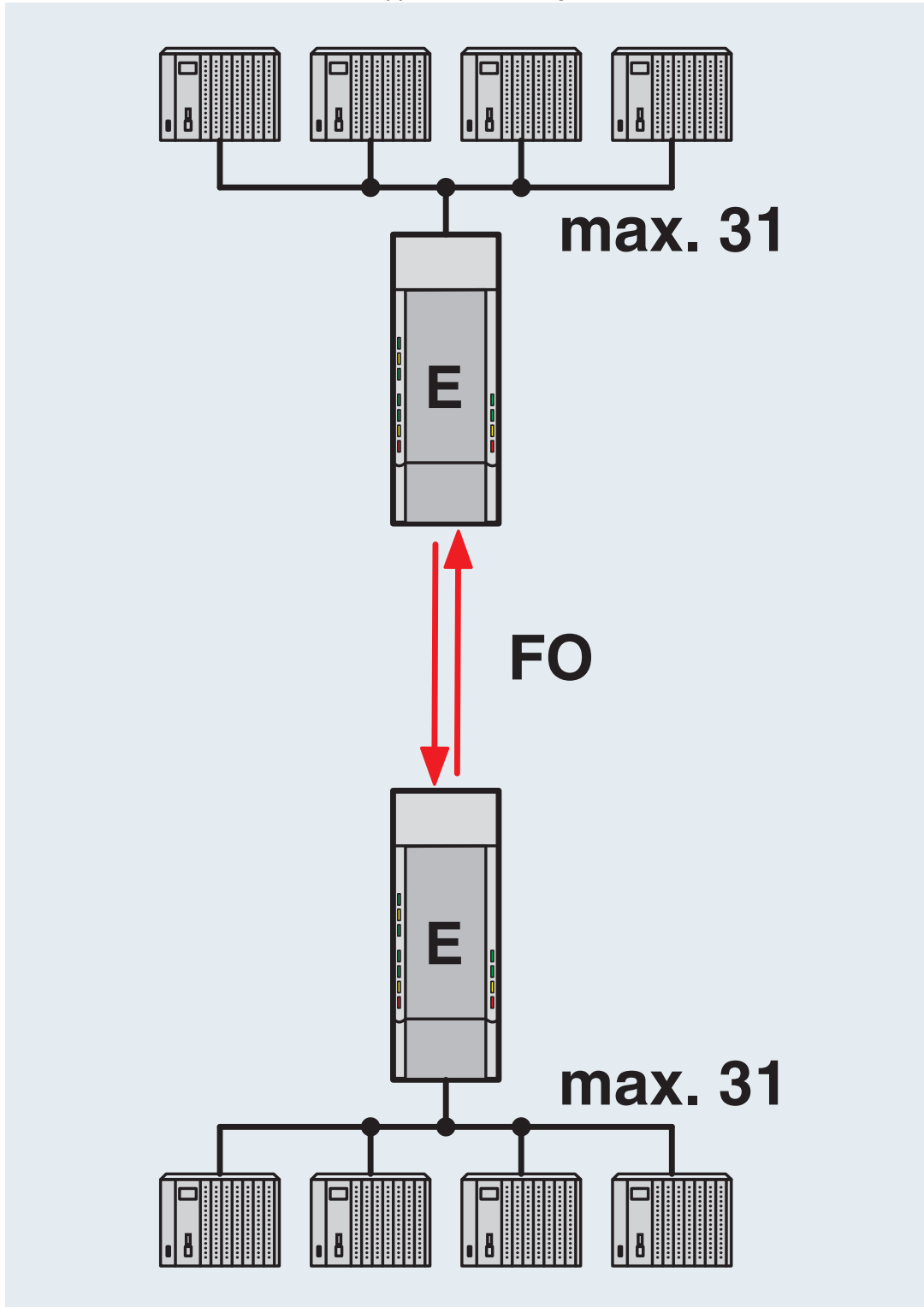

Point-to-point connection

PSI-MOS-RS485W2/FO 850 E - FO converters



2708339

<https://www.phoenixcontact.com/in/products/2708339>

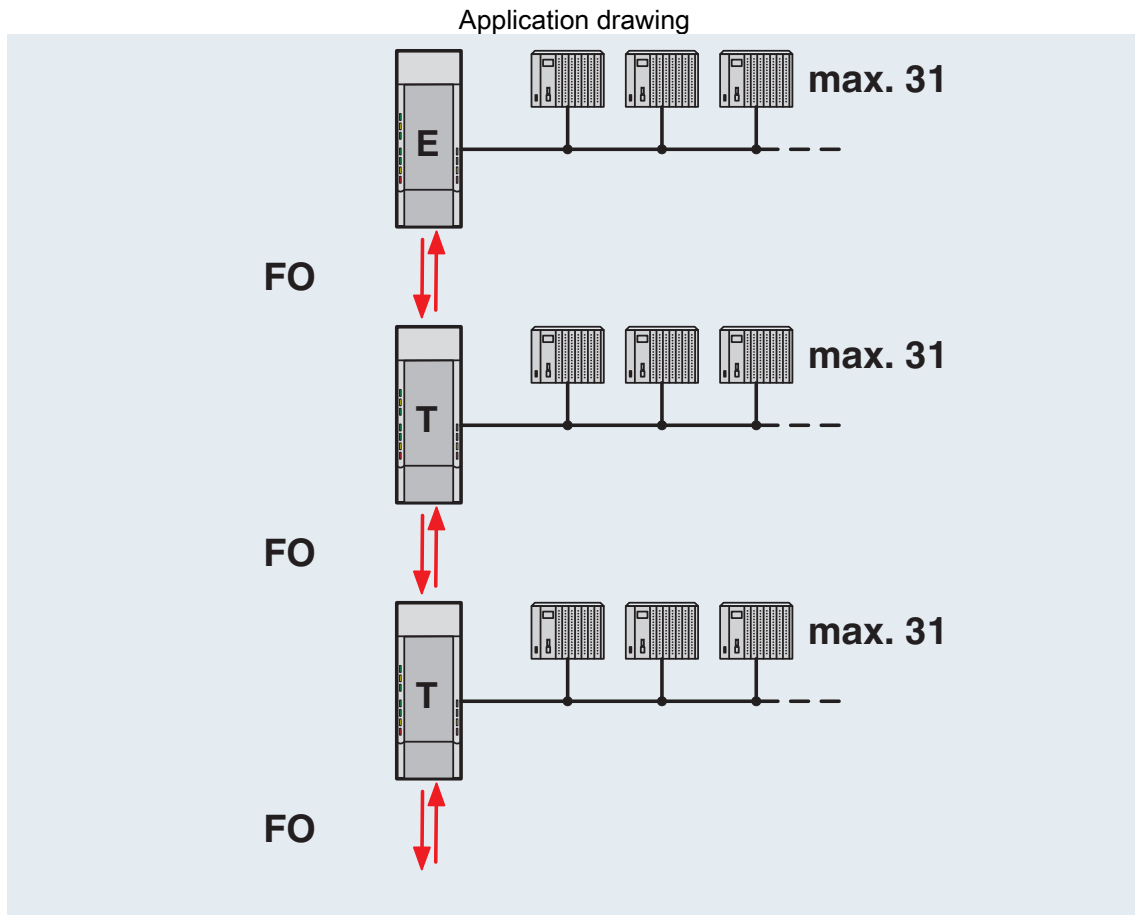

Line structure

PSI-MOS-RS485W2/FO 850 E - FO converters



2708339

<https://www.phoenixcontact.com/in/products/2708339>

Schematic diagram

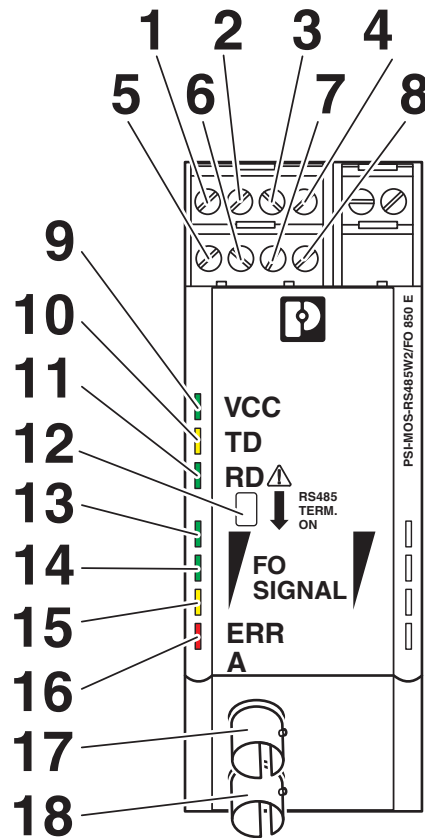

Front view

PSI-MOS-RS485W2/FO 850 E - FO converters



2708339

<https://www.phoenixcontact.com/in/products/2708339>

Approvals



EAC

Approval ID: TR TS_D_01871-19



DNV GL

Approval ID: TAA00001KR



KC

Approval ID: KCC-REI-PCK-FOCVT270



UL Listed

Approval ID: FILE E 238705



cUL Listed

Approval ID: FILE E 238705



ATEX

Approval ID: PTB 06 ATEX 2042U



ATEX

Approval ID: PxCIF06ATEX2708261X



cUL Listed

Approval ID: FILE E 199827



UL Listed

Approval ID: FILE E 199827



IECEX

Approval ID: IECEX ULD 21.0013X



ATEX

Approval ID: UL 21 ATEX 2550X

PSI-MOS-RS485W2/FO 850 E - FO converters



2708339

<https://www.phoenixcontact.com/in/products/2708339>

Classifications

ECLASS

ECLASS-11.0	19170411
ECLASS-12.0	19170411
ECLASS-13.0	19170411

ETIM

ETIM 8.0	EC001467
----------	----------

UNSPSC

UNSPSC 21.0	43201500
-------------	----------

PSI-MOS-RS485W2/FO 850 E - FO converters



2708339

<https://www.phoenixcontact.com/in/products/2708339>

Environmental Product Compliance

China RoHS	Environmentally Friendly Use Period = 50 years For information on hazardous substances, refer to the manufacturer's declaration available under "Downloads"
------------	--

PSI-MOS-RS485W2/FO 850 E - FO converters



2708339

<https://www.phoenixcontact.com/in/products/2708339>

Accessories

PSM-SET-B-FOC/4-HCS - FO connectors

2708481

<https://www.phoenixcontact.com/in/products/2708481>

FO connectors, degree of protection: IP20, number of positions: 4, MM, material: Metal, connection method: Cable connection, cable outlet: straight



PSM-LWL-HCS-RUGGED-200/230 - FO cable

2799885

<https://www.phoenixcontact.com/in/products/2799885>

PCF cable, duplex 200 μm /230 μm , by the meter without male connector, for installation in stationary systems and machines



PSI-MOS-RS485W2/FO 850 E - FO converters

2708339

<https://www.phoenixcontact.com/in/products/2708339>

PSM-LWL-HCSO-200/230 - FO cable

2799445

<https://www.phoenixcontact.com/in/products/2799445>



PCF cable, duplex 200/230 μm , by the meter, without connector, for outdoor installation

PSM-LWL-GDM-RUGGED- 50/125 - FO cable

2799322

<https://www.phoenixcontact.com/in/products/2799322>



Fiber glass cable, duplex 50 μm /125 μm , by the meter, without male connector, for installation in stationary systems and machines

PSI-MOS-RS485W2/FO 850 E - FO converters

2708339

<https://www.phoenixcontact.com/in/products/2708339>

PSM-LWL-GDO- 50/125 - FO cable

2799432

<https://www.phoenixcontact.com/in/products/2799432>



Fiberglass cable, duplex 50/125 μm , by the meter, without connector, for outdoor installation

QUINT4-SYS-PS/1AC/24DC/2.5/SC - Power supply unit

2904614

<https://www.phoenixcontact.com/in/products/2904614>



Primary-switched power supply, QUINT POWER, screw connection, DIN rail mounting, supply of devices possible via the TBUS DIN rail connector, protective coating, input: single-phase, output: 24 V DC/2.5 A

PSI-MOS-RS485W2/FO 850 E - FO converters



2708339

<https://www.phoenixcontact.com/in/products/2708339>

ME 17,5 TBUS 1,5/ 5-ST-3,81 KMGY - DIN rail bus connectors

2713645

<https://www.phoenixcontact.com/in/products/2713645>

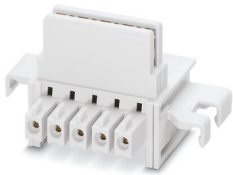

DIN rail connector, color: light grey, nominal current: 8 A (parallel contacts), rated voltage (III/2): 125 V, number of positions: 5, pitch: 3.81 mm, mounting: DIN rail mounting, locking: without, mounting: without, type of packaging: packed in cardboard, Item with gold-plated contacts, bus connectors for connecting with electronics housings, 5 parallel contacts

PSM-HCS-KONFTOOL/B-FOC - Assembly tool

2708465

<https://www.phoenixcontact.com/in/products/2708465>



HCS assembly kit for B-FOC(ST) quick mounting connectors, including stripping blade, stripping pliers, aramide yarn scissors, fiber stripper, microscope, fiber cleaving tool for standard HCS and HCS GI fibers, four B-FOC(ST) connectors for standard HCS fiber, and documentation

PSI-MOS-RS485W2/FO 850 E - FO converters

2708339

<https://www.phoenixcontact.com/in/products/2708339>



PSM-FO-POWERMETER - Measuring instrument

2799539

<https://www.phoenixcontact.com/in/products/2799539>



Fiber optic measuring case, consisting of an optical power meter, F-SMA, B-FOC adapters, reference fibers and operating instructions

SZS 0,4X2,5 VDE - Screwdriver

1205037

<https://www.phoenixcontact.com/in/products/1205037>



Screwdriver, slot-headed, VDE insulated, size: 0.4 x 2.5 x 80 mm, 2-component grip, with non-slip grip

PSI-MOS-RS485W2/FO 850 E - FO converters

2708339

<https://www.phoenixcontact.com/in/products/2708339>



PSM-STRIP-FC/PROFIB - Stripping tool

2744623

<https://www.phoenixcontact.com/in/products/2744623>

Quick stripping tool for PROFIBUS cable, type Fast Connect



PSM PTK - Connection distributor

2760623

<https://www.phoenixcontact.com/in/products/2760623>

Passive RS-485 T-distributor, fitted with one 9-pin D-SUB pin strip and two 9-pin D-SUB socket strips

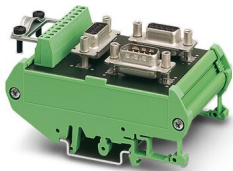

PSI-MOS-RS485W2/FO 850 E - FO converters

2708339

<https://www.phoenixcontact.com/in/products/2708339>



PSM PTK-4 - Connection distributor

2799364

<https://www.phoenixcontact.com/in/products/2799364>



Passive RS-485 T-distributor, fitted with one 9-pin D-SUB pin strip and five 9-pin D-SUB socket strips

PSI-REP-RS485W2 - Repeater

2313096

<https://www.phoenixcontact.com/in/products/2313096>



Modular repeater for electrical isolation and range increase in RS-485 2-wire bus systems up to 500 kbps, 4-way isolation, rail-mountable, supply 24 V DC

PSI-MOS-RS485W2/FO 850 E - FO converters

2708339

<https://www.phoenixcontact.com/in/products/2708339>

PSM-ME-RS485/RS485-P - Repeater

2744429

<https://www.phoenixcontact.com/in/products/2744429>



Repeater, for potential separation and range increase in RS-485 2-wire bus systems, 3-way isolation, rail-mountable

PSM-CABLE-PROFIB/FC - Bus system cable

2744652

<https://www.phoenixcontact.com/in/products/2744652>



By the meter, Bus system cable, PROFIBUS (12 Mbps), shielded, PVC FR VI/PVC, violet, 2-wire (1X2XAWG22/1), color single wire: red, green, cable length: Free entry (1.0 ... 1000.0 m)

PSI-MOS-RS485W2/FO 850 E - FO converters

2708339

<https://www.phoenixcontact.com/in/products/2708339>

SUBCON-PLUS M1 - D-SUB bus connector

2761826

<https://www.phoenixcontact.com/in/products/2761826>



D-SUB connector, 9-pos., male connector, two 35° cable entries, bus system: Modbus, Modbus Plus, BITBUS, ARCNET, MULT/MININET (B&R), SYSTEM 2003 (B&R), P-NET, pin assignment: 1, 2, 3, 5, 6, 8 to two screw connection terminal blocks

SUBCON-PLUS F1 - D-SUB bus connector

2744267

<https://www.phoenixcontact.com/in/products/2744267>



D-SUB connector, 9-pos. female connector, two 35° cable entries, bus system: Modbus, Modbus Plus, BITBUS, ARCNET, MULT/MININET (B&R), SYSTEM 2003 (B&R), P-NET, pin assignment: 1, 2, 3, 5, 6, 8; screw connection terminal blocks

PSI-MOS-RS485W2/FO 850 E - FO converters

2708339

<https://www.phoenixcontact.com/in/products/2708339>

SUBCON-PLUS M2 - D-SUB bus connector

2761839

<https://www.phoenixcontact.com/in/products/2761839>



D-SUB connector, 9-pos., male connector, two 35° cable entries, bus system: CAN, SUCONET K1, K2 (MOELLER), S-BUS (Saia), J-BUS (Merlin Gerin), pin assignment: 2, 3, 4, 5, 7, 9 to two screw connection terminal blocks

SUBCON-PLUS F2 - D-SUB bus connector

2799490

<https://www.phoenixcontact.com/in/products/2799490>



D-SUB connector, 9-pos. female connector, two 35° cable entries, bus system: CAN, SUCONET K1, K2 (MOELLER), S-BUS (Saia), J-BUS (Merlin Gerin), pin assignment: 2, 3, 4, 5, 7, 9 to two screw connection terminal blocks

PSI-MOS-RS485W2/FO 850 E - FO converters

2708339

<https://www.phoenixcontact.com/in/products/2708339>

SUBCON-PLUS 9/M - D-SUB bus connector

2744018

<https://www.phoenixcontact.com/in/products/2744018>



D-SUB connector, 9-pos., male connector, two 35° cable entries, universal type for all systems, pin assignment: 1, 2, 3, 4, 5, 6, 7, 8, 9 to one screw connection terminal block

SUBCON-PLUS 9/F - D-SUB bus connector

2744241

<https://www.phoenixcontact.com/in/products/2744241>



D-SUB connector, 9-pos. female connector, two 35° cable entries, universal type for all systems, pin assignment: 1, 2, 3, 4, 5, 6, 7, 8, 9 to one screw connection terminal block

PSI-MOS-RS485W2/FO 850 E - FO converters

2708339

<https://www.phoenixcontact.com/in/products/2708339>

FOC-ST:PA-SC:PA-OM2:D01/1 - FO patch cable

1115574

<https://www.phoenixcontact.com/in/products/1115574>

Multi-mode OM2 duplex jumper, ST-SC, UPC polishing, length 1 m

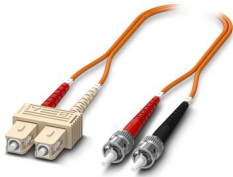

FOC-ST:PA-SC:PA-OM2:D01/2 - FO patch cable

1115573

<https://www.phoenixcontact.com/in/products/1115573>

Multi-mode OM2 duplex jumper, ST-SC, UPC polishing, length 2 m

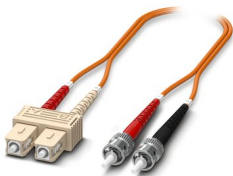

PSI-MOS-RS485W2/FO 850 E - FO converters

2708339

<https://www.phoenixcontact.com/in/products/2708339>

FOC-ST:PA-ST:PA-OM2:D01/1 - FO patch cable

1115560

<https://www.phoenixcontact.com/in/products/1115560>

Multi-mode OM2 duplex jumper, ST-ST, UPC polishing, length 1 m



FOC-ST:PA-ST:PA-OM2:D01/2 - FO patch cable

1115557

<https://www.phoenixcontact.com/in/products/1115557>

Multi-mode OM2 duplex jumper, ST-ST, UPC polishing, length 2 m



PSI-MOS-RS485W2/FO 850 E - FO converters

2708339

<https://www.phoenixcontact.com/in/products/2708339>

FOC-LC:PA-ST:PA-OM2:D01/1 - Fiber optic cable

1115588

<https://www.phoenixcontact.com/in/products/1115588>

Multi-mode OM2 duplex jumper, LC-ST, UPC polishing, length 1 m

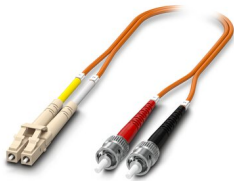

FOC-LC:PA-ST:PA-OM2:D01/2 - Fiber optic cable

1115587

<https://www.phoenixcontact.com/in/products/1115587>

Multi-mode OM2 duplex jumper, LC-ST, UPC polishing, length 2 m

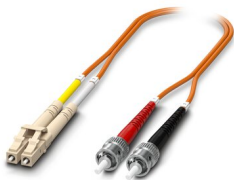

PSI-MOS-RS485W2/FO 850 E - FO converters

2708339

<https://www.phoenixcontact.com/in/products/2708339>

FOC-LC:PA-ST:PA-OM1:D01/1 - FO patch cable

1146499

<https://www.phoenixcontact.com/in/products/1146499>

Multi-mode OM1 duplex jumper, LC-ST, UPC polishing, length 1 m

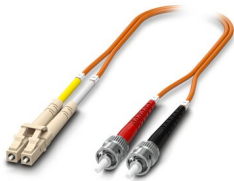

FOC-LC:PA-ST:PA-OM1:D01/2 - FO patch cable

1146508

<https://www.phoenixcontact.com/in/products/1146508>

Multi-mode OM1 duplex jumper, LC-ST, UPC polishing, length 2 m

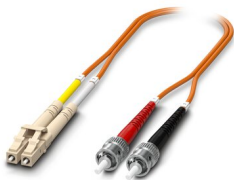

PSI-MOS-RS485W2/FO 850 E - FO converters

2708339

<https://www.phoenixcontact.com/in/products/2708339>

FOC-ST:PA-ST:PA-OM1:D01/1 - FO patch cable

1146501

<https://www.phoenixcontact.com/in/products/1146501>

Multi-mode OM1 duplex jumper, ST-ST, UPC polishing, length 1 m



FOC-ST:PA-ST:PA-OM1:D01/2 - FO patch cable

1146509

<https://www.phoenixcontact.com/in/products/1146509>

Multi-mode OM1 duplex jumper, ST-ST, UPC polishing, length 2 m



PSI-MOS-RS485W2/FO 850 E - FO converters

2708339

<https://www.phoenixcontact.com/in/products/2708339>



PSI-TERMINATOR-PB-TBUS - Termination resistor

2702636

<https://www.phoenixcontact.com/in/products/2702636>



Active termination resistor for PROFIBUS and RS-485 bus systems, redundant power supply, routing of the supply voltage via DIN rail connector, electrical isolation, switchable termination, integrated programming interface

PSI-MOS-RS485W2/FO 850 T - FO converters

2708326

<https://www.phoenixcontact.com/in/products/2708326>



FO converter with integrated optical diagnostics, alarm contact, for RS-485 2-wire bus systems (SUCONET K, Modbus ...) up to 500 kbps, NRZ coding, T-coupler with two FO interfaces (BFOC), 850 nm, for PCF/fiberglass cable (multimode)

PSI-MOS-RS485W2/FO 850 E - FO converters

2708339

<https://www.phoenixcontact.com/in/products/2708339>

FOC-HCS-RUGGED-1014/IP20/... - FO patch cable

2901555

<https://www.phoenixcontact.com/in/products/2901555>

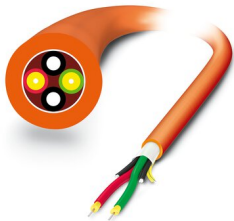

Robust PCF installation cable for assembly (IP20 heads only) for installation in stationary systems and machines, aramid strain relief elements, with individual elements made from FRNC material, halogen-free, ozone and UV resistant, with a polyurethane (PUR) outer sheath

FOC-HCSO-1015/IP20/... - FO patch cable

2901557

<https://www.phoenixcontact.com/in/products/2901557>



Highly rugged PCF round cable (IP20 heads only) for assembly and for outdoor installation with integrated moisture barrier as well as rodent-proof scrim. Individual elements made from highly flexible FRNC material. The wire is ozone and UV resistant with a very rugged polyethylene outer sheath.

PSI-MOS-RS485W2/FO 850 E - FO converters



2708339

<https://www.phoenixcontact.com/in/products/2708339>

FOC-GDM-RUGGED-1016/IP20/... - FO patch cable

2901558

<https://www.phoenixcontact.com/in/products/2901558>

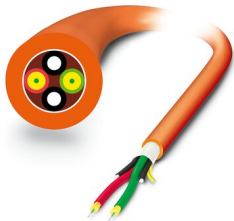

Robust GOF installation cable for assembly (IP20 heads only) for installation in stationary systems and machines, aramid strain-relief elements, with individual elements made from FRNC material, halogen-free, ozone and UV resistant, with a polyurethane (PUR) outer sheath

FOC-GDO-1017/IP20/... - FO patch cable

2901559

<https://www.phoenixcontact.com/in/products/2901559>



Highly rugged GOF round cable (IP20 heads only) for assembly and for outdoor installation with integrated moisture barrier as well as rodent-proof scrim. Individual elements made from highly flexible FRNC material. The wire is ozone and UV resistant with a very rugged polyethylene outer sheath.

Phoenix Contact 2023 © - all rights reserved
<https://www.phoenixcontact.com>

PHOENIX CONTACT (I) Pvt. Ltd.
A-58/2, Okhla Industrial Area, Phase - II, New Delhi-110 020

+91.1275.71420
info@phoenixcontact.co.in