

# FL SWITCH 2016 - Industrial Ethernet Switch



2702903

<https://www.phoenixcontact.com/in/products/2702903>

Please be informed that the data shown in this PDF document is generated from our Online Catalog. Please find the complete data in the user documentation. Our General Terms of Use for Downloads are valid.

Managed Switch 2000, 16 RJ45 ports 10/100 Mbps, PROFINET Conformance-Class A



## Your advantages

- Unmanaged Mode
- MRP client
- VLANs
- DHCP client, DHCP server (port-based)
- RSTP
- Configuration memory
- Web-based management, SNMP
- Easy and fast startup and commissioning with the FL NETWORK MANAGER software
- Suitable for PROFINET and EtherNet/IP™ networks

## Commercial Data

Item number	2702903
Packing unit	1 pc
Minimum order quantity	1 pc
Sales Key	DNN
Product Key	DNN121
Catalog Page	Page 305 (C-6-2019)
GTIN	4055626397207
Weight per Piece (including packing)	554.4 g
Weight per Piece (excluding packing)	435 g
Customs tariff number	85176200
Country of origin	DE

## Technical Data

### Dimensions

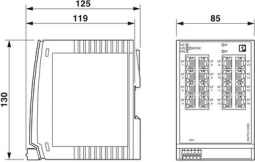
Dimensional drawing	
Width	85 mm
Height	130 mm
Depth	119 mm

### Notes

General	Support by phone or on-site (fee is charged)
---------	--

### Material specifications

Housing material	Polycarbonate fiber reinforced
------------------	--------------------------------

### Mounting

Mounting type	DIN rail mounting
---------------	-------------------

### Interfaces

#### Ethernet (RJ45)

Connection method	RJ45
Note on the connection method	Auto negotiation and autocrossing
Transmission speed	10/100 Mbps
Transmission physics	Copper
Transmission length	100 m (per segment)
Signal LEDs	Data receive, link status
No. of channels	16 (RJ45 ports)

### Product properties

Type	Book type
Product type	Switch
Product family	Managed Switch 2000
MTTF	365.63 Years (SN 29500 standard, temperature 25°C, operating cycle 21%)
	218.22 Years (SN 29500 standard, temperature 40°C, operating cycle 34.25%)
	46.17 Years (SN 29500 standard, temperature 55°C, operating cycle 100%)
Signal delay	≥ 6.5 μs (Store and Forward mode, 10/100 Mbps, depending on the frame size)

# FL SWITCH 2016 - Industrial Ethernet Switch



2702903

<https://www.phoenixcontact.com/in/products/2702903>

## Insulation characteristics

Protection class	III (VDE 0106)
Degree of pollution	2

## Switch functions

Diagnostic functions	RMON History
	LLDP (Link Layer Discovery Protocol)
	SNMP-Traps
	N:1-Portmirroring
	ACD (Address Conflict Detection)
	SysLog
	CRC-Surveillance
Basic functions	Store-and-forward switch, complies with IEEE 802.3
PROFINET conformance class	Conformance-Class A
Filter functions	Quality of Service (8 priority classes)
	Class of Service
	DiffServ/DSCP
	Port-Priorisierung
	VLAN (up to 8 VLANs)
	IGMP Snooping/Querier (v1/v2)
	Auto-Query-Port
IP parameterization	Extended Multicast Filtering
	DHCP-Client
	DHCP server (port based)
MAC address table	BootP
	8k
Management	Web-based management (HTTP/HTTPS)
	Role-based user management (LDAP)
	SNMPv1/v2/v3
	Command-line interface (Telnet, SSH)
Redundancy	MRP (Media Redundancy Protocol)
	RSTP (Rapid Spanning Tree Protocol)
Status and diagnostic indicators	LEDs: US (power supply), 2 LEDs per Ethernet port (Link/Activity and Speed)
Additional functions	Transmission of MMS and GOOSE (IEC 61850-8-1)
	Transmission of Modbus/TCP
Time synchronization	SNTP (Simple Network Time Protocol)

## Security functions

Basic functions	Store-and-forward switch, complies with IEEE 802.3
-----------------	--

## Electrical properties

Local diagnostics	US Supply voltage Green LED
	LNK/ACT Link status Green LED
	SPD Data transmission speed Green LED

# FL SWITCH 2016 - Industrial Ethernet Switch



2702903

<https://www.phoenixcontact.com/in/products/2702903>

Maximum power dissipation for nominal condition	9 W (At $U_S = 18$ V DC and 60°C ambient temperature)
Test voltage	500 V DC
Test section	for one minute 500 V DC
Transmission medium	Copper

## Supply

Supply voltage (DC)	24 V DC (single)
Supply voltage range	18 V DC ... 32 V DC
Power supply connection	via COMBICON, max. conductor cross section 1.5 mm <sup>2</sup>
Residual ripple	3.6 V <sub>PP</sub> (within the permitted voltage range)
Max. current consumption	0.5 A (At $U_S = 18$ V DC and 60°C ambient temperature)
Typical current consumption	315 mA (at $U_S = 24$ V DC and 25 °C ambient temperature)
Current consumption	315 mA

## Connection data

Connection method	Push-in spring connection
Note on the connection method	Use only copper connecting cables providing the permitted temperature range (-40 °C ... 75 °C).
Conductor cross section, rigid	0.25 mm <sup>2</sup> ... 1.5 mm <sup>2</sup>
Conductor cross section, flexible	0.25 mm <sup>2</sup> ... 1.5 mm <sup>2</sup>
Conductor cross section AWG	24 ... 16
Stripping length	9 mm

## Environmental and real-life conditions

### Ambient conditions

Degree of protection	IP20
Ambient temperature (operation)	0 °C ... 60 °C
Ambient temperature (storage/transport)	-40 °C ... 85 °C
Permissible humidity (operation)	10 % ... 95 % (non-condensing)
Permissible humidity (storage/transport)	10 % ... 95 % (non-condensing)
Shock (operation)	30g (EN 60068-2-27)
Vibration (operation)	2g, according to IEC 60068-2-6
Air pressure (operation)	86 kPa ... 108 kPa (1500 m above sea level)
Air pressure (storage/transport)	86 kPa ... 108 kPa (1500 m above sea level)

## Standards and regulations

Free from substances that could impair the application of coating	Yes
---	-----

## Approvals

### UL, USA/Canada

Identification	cULus
Note	UL 61010-1, Ed. 3 / UL 61010-2-201, Ed. 1, CSA C22.2 NO. 61010-2-201:14, Ed. 1 / CSA C22.2 NO.61010-1-12, Ed. 3

## EMC data

# FL SWITCH 2016 - Industrial Ethernet Switch



2702903

<https://www.phoenixcontact.com/in/products/2702903>

Conformance with EMC directives	EN 61000-6-2 EN 61000-4-2 (ESD) Criterion B
	EN 61000-6-2 EN 61000-4-3 (electromagnetic fields) Criterion A
	EN 61000-6-2 EN 61000-4-4 (EFT burst) Criterion A
	EN 61000-6-2 EN 61000-4-5 (surge) Criterion B
	EN 61000-6-2 EN 61000-4-6 (line noise immunity) Criterion A
	EN 61000-6-2 EN 61000-6-3 (noise emission) Class B
	EN 61000-6-2 EN 61000-6-3 (conducted emissions) Class B
Noise immunity	EN 61000-6-2
Electromagnetic compatibility	Conformance with EMC Directive 2014/30/EU
Noise emission	EN 61000-6-4

## System properties

### Functionality

Basic functions	Store-and-forward switch, complies with IEEE 802.3
-----------------	--

## Signaling

Status display	LEDs: US (power supply), 2 LEDs per Ethernet port (Link/Activity and Speed)
----------------	---

# FL SWITCH 2016 - Industrial Ethernet Switch



2702903

<https://www.phoenixcontact.com/in/products/2702903>

## Drawings

Dimensional drawing

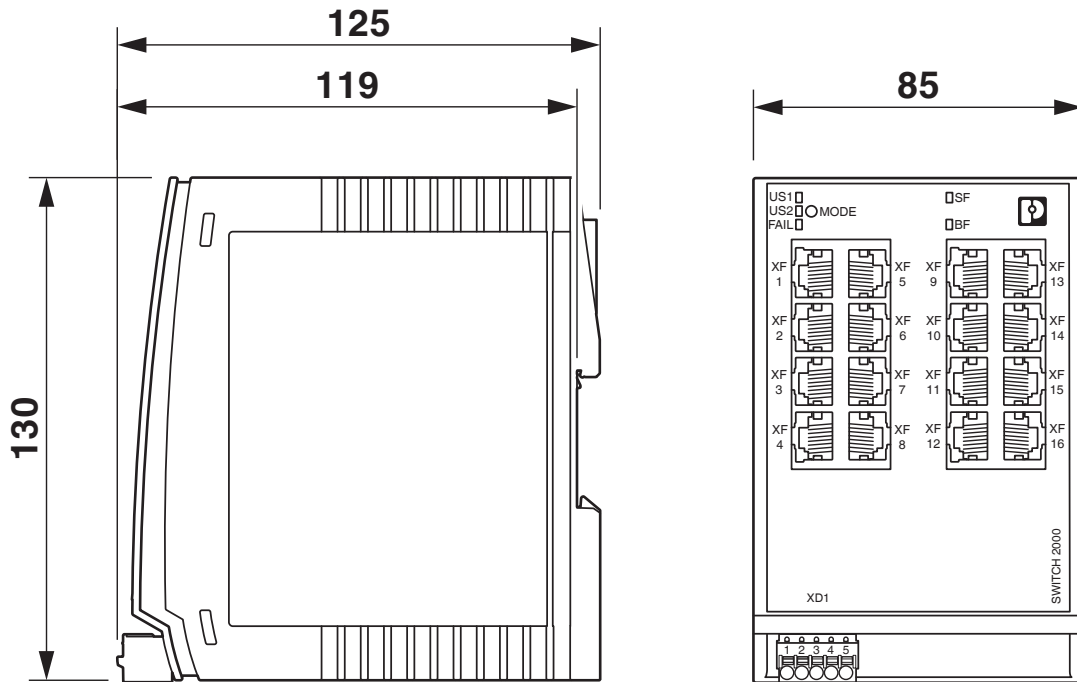

# FL SWITCH 2016 - Industrial Ethernet Switch



2702903

<https://www.phoenixcontact.com/in/products/2702903>

## Approvals



**EAC**

Approval ID: RU\*-DE.\*.B.00741/19



**UL Listed**

Approval ID: FILE E 238705



**cUL Listed**

Approval ID: FILE E 238705



**cUL Listed**

Approval ID: FILE E 238705



**UL Listed**

Approval ID: FILE E 238705

# FL SWITCH 2016 - Industrial Ethernet Switch



2702903

<https://www.phoenixcontact.com/in/products/2702903>

## Classifications

### ECLASS

ECLASS-11.0	19170401
ECLASS-12.0	19170401
ECLASS-13.0	19170401

### ETIM

ETIM 8.0	EC000734
----------	----------

### UNSPSC

UNSPSC 21.0	43222600
-------------	----------



# FL SWITCH 2016 - Industrial Ethernet Switch



2702903

<https://www.phoenixcontact.com/in/products/2702903>

## Environmental Product Compliance

REACH SVHC	Lead 7439-92-1
China RoHS	Environmentally Friendly Use Period = 50 years
	For information on hazardous substances, refer to the manufacturer's declaration available under "Downloads"

# FL SWITCH 2016 - Industrial Ethernet Switch



2702903

<https://www.phoenixcontact.com/in/products/2702903>

## Accessories

### SD FLASH 2GB - Program / configuration memory

2988162

<https://www.phoenixcontact.com/in/products/2988162>



Program and configuration memory, for extending the internal flash memory, pluggable, 2 GB.

---

### FL NETWORK MANAGER BASIC - Network management software

2702889

<https://www.phoenixcontact.com/in/products/2702889>

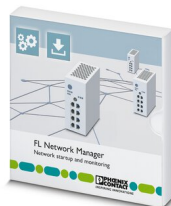

SNMP-based software for easy commissioning and monitoring of network components such as switches, routers, and WLAN access points

# FL SWITCH 2016 - Industrial Ethernet Switch



2702903

<https://www.phoenixcontact.com/in/products/2702903>

## FL DIN RA - DIN rail adapter

2891053

<https://www.phoenixcontact.com/in/products/2891053>

The FL DIN RA is installed in a standard, 19-inch rack (EIA-310-D, IEC 60297-3-100) to allow DIN rail mounted equipment to be rack mounted.

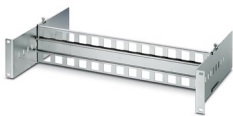

---

## FL RJ45 PROTECT CAP - Dust protection

2832991

<https://www.phoenixcontact.com/in/products/2832991>

Dust protection caps for RJ45 socket

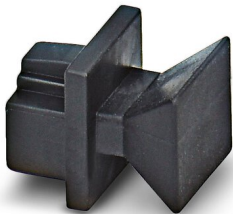

# FL SWITCH 2016 - Industrial Ethernet Switch

2702903

<https://www.phoenixcontact.com/in/products/2702903>

## E/NS 35 N - End clamp

0800886

<https://www.phoenixcontact.com/in/products/0800886>

End clamp, width: 9.5 mm, color: gray



---

## FK-MCP 1,5/ 5-ST-3,81GY35BD1-5 - PCB connector

1015782

<https://www.phoenixcontact.com/in/products/1015782>



PCB connector, nominal cross section: 1.5 mm<sup>2</sup>, color: light grey, nominal current: 8 A, rated voltage (III/2): 160 V, contact surface: Tin, type of contact: Socket, number of potentials: 5, number of rows: 1, number of positions: 5, number of connections: 5, product range: FK-MCP 1,5/...-ST, pitch: 3.81 mm, connection method: Push-in spring connection, conductor/PCB connection direction: 0 °, plug-in system: COMBICON MC 1,5, locking: without, mounting: without, type of packaging: packed in cardboard

# FL SWITCH 2016 - Industrial Ethernet Switch



2702903

<https://www.phoenixcontact.com/in/products/2702903>

## MCVW 1,5/ 5-ST-3,81GY7035BD2US - PCB connector

1034103

<https://www.phoenixcontact.com/in/products/1034103>

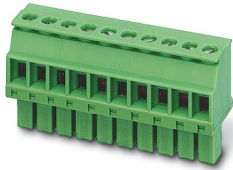

PCB connector, nominal cross section: 1.5 mm<sup>2</sup>, color: light grey, nominal current: 8 A, rated voltage (III/2): 160 V, contact surface: Tin, type of contact: Socket, number of potentials: 5, number of rows: 1, number of positions: 5, number of connections: 5, product range: MCVW 1,5/...-ST, pitch: 3.81 mm, connection method: Screw connection with tension sleeve, screw head form: L Slotted, conductor/PCB connection direction: -90 °, plug-in system: COMBICON MC 1,5, locking: without, mounting: without, type of packaging: packed in cardboard

---

## FL CAT5 PATCH 0,5 - Patch cable

2832263

<https://www.phoenixcontact.com/in/products/2832263>



Patch cable, CAT5, assembled, 0.5 m

# FL SWITCH 2016 - Industrial Ethernet Switch

2702903

<https://www.phoenixcontact.com/in/products/2702903>

## FL CAT5 PATCH 1,0 - Patch cable

2832276

<https://www.phoenixcontact.com/in/products/2832276>

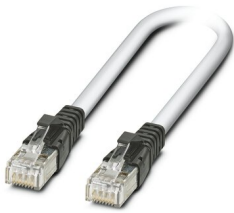

Patch cable, CAT5, assembled, 1 m

---

## FL CAT5 PATCH 2,0 - Patch cable

2832289

<https://www.phoenixcontact.com/in/products/2832289>

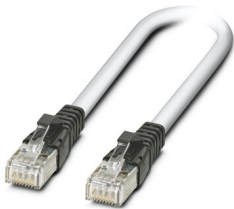

Patch cable, CAT5, assembled, 2 m

# FL SWITCH 2016 - Industrial Ethernet Switch



2702903

<https://www.phoenixcontact.com/in/products/2702903>

## NBC-R4AC-R4AC-IE8A/.../... - Patch cable

1411854

<https://www.phoenixcontact.com/in/products/1411854>

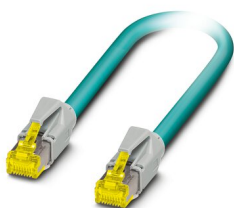

Patch cable, degree of protection: IP20, number of positions: 8, 10 Gbps, CAT6<sub>A</sub>, cable outlet: straight, Ethernet

---

## NBC-R4AC/10G-R4AC/10G-94F/2,0 - Patch cable

1408360

<https://www.phoenixcontact.com/in/products/1408360>

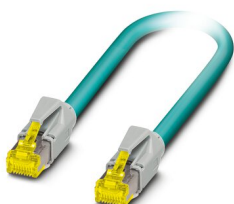

Patch cable, CAT6<sub>A</sub>, 4-pair, shielded, connection not crossed (line), assembled at both ends with RJ45/IP20 connectors, outer sheath material: PUR, length: 2.0 m

# FL SWITCH 2016 - Industrial Ethernet Switch



2702903

<https://www.phoenixcontact.com/in/products/2702903>

## NBC-R4AC/10G-R4AC/10G-94F/3,0 - Patch cable

1408365

<https://www.phoenixcontact.com/in/products/1408365>

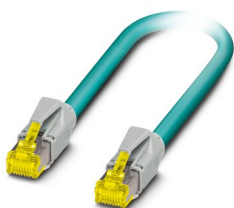

Patch cable, CAT6<sub>A</sub>, 4-pair, shielded, connection not crossed (line), assembled at both ends with RJ45/IP20 connectors, outer sheath material: PUR, length: 3.0 m

---

## NBC-R4AC/1,0-93B/R4AC - Patch cable

1408968

<https://www.phoenixcontact.com/in/products/1408968>



Patch cable, degree of protection: IP20, cable length: 1 m, number of positions: 4, 100 Mbps, CAT5, material: PA 6.6, PROFINET



# FL SWITCH 2016 - Industrial Ethernet Switch



2702903

<https://www.phoenixcontact.com/in/products/2702903>

## NBC-R4AC/2,0-93B/R4AC - Patch cable

1408969

<https://www.phoenixcontact.com/in/products/1408969>



Patch cable, degree of protection: IP20, cable length: 2 m, number of positions: 4, 100 Mbps, CAT5, material: PA 6.6, PROFINET

---

## NBC-R4AC/5,0-93B/R4AC - Patch cable

1408970

<https://www.phoenixcontact.com/in/products/1408970>



Patch cable, degree of protection: IP20, cable length: 5 m, number of positions: 4, 100 Mbps, CAT5, material: PA 6.6, PROFINET

# FL SWITCH 2016 - Industrial Ethernet Switch



2702903

<https://www.phoenixcontact.com/in/products/2702903>

## VS-08-RJ45-5-Q/IP20 - RJ45 connector

1656725

<https://www.phoenixcontact.com/in/products/1656725>



RJ45 connector, design: RJ45, degree of protection: IP20, number of positions: 8, 1 Gbps, CAT5, material: Plastic, connection method: Insulation displacement connection, connection cross section: AWG 26- 23, cable outlet: straight, color: traffic grey A RAL 7042, Ethernet

---

Phoenix Contact 2023 © - all rights reserved

<https://www.phoenixcontact.com>

PHOENIX CONTACT (I) Pvt. Ltd.

A-58/2, Okhla Industrial Area, Phase - II, New Delhi-110 020

+91.1275.71420

[info@phoenixcontact.co.in](mailto:info@phoenixcontact.co.in)