

GW MODBUS TCP/RTU 2E/4DB9 - Interface converters



2702767

<https://www.phoenixcontact.com/in/products/2702767>

Please be informed that the data shown in this PDF document is generated from our online catalog. Please find the complete data in the user documentation. Our general terms of use for downloads are valid.



The GW MODBUS TCP/RTU... gateway converts serial based Modbus RTU (or ASCII) to Modbus TCP. Supports serial client or server devices. Includes two RJ45 ports and four D-SUB 9 ports.

Commercial data

Item number	2702767
Packing unit	1 pc
Minimum order quantity	1 pc
Sales key	DNC
Product key	DNC323
Catalog page	Page 355 (C-6-2019)
GTIN	4055626339344
Weight per piece (including packing)	246 g
Weight per piece (excluding packing)	246 g
Customs tariff number	85176200
Country of origin	US

GW MODBUS TCP/RTU 2E/4DB9 - Interface converters



2702767

<https://www.phoenixcontact.com/in/products/2702767>

Technical data

Notes

Note on application

Note on application	Only for industrial use
---------------------	-------------------------

Utilization restriction

EMC note	EMC: class A product, see manufacturer's declaration in the download area
----------	---

Utilization restriction

CCCex note	Use in potentially explosive areas is not permitted in China.
------------	---

Product properties

Product type	Interface converter
MTBF	63.5 Years (Telcordia standard, 25°C temperature, 50% stress, Environmental Factor = 1.0)
	42.3 Years (Telcordia standard, 40°C temperature, 50% stress, Environmental Factor = 1.5)

Data management status

Article revision	06
------------------	----

Electrical properties

Electrical isolation	IEC UL 61010-1 (VCC // Ethernet)
Test voltage data interface/data interface	1.5 kV _{rms} (50 Hz, 1 min.)
Test voltage data interface/power supply	1.5 kV _{rms} (50 Hz, 1 min.)
	1.5 kV _{rms}

Supply

Supply voltage range	10.8 V DC ... 30 V DC (via pluggable COMBICON screw terminal block)
Typical current consumption	110 mA (24 V DC)
Max. current consumption	120 mA (24 V DC)

Function

Management	Web-based management
Status and diagnostic indicators	LEDs: Status, ACT/LNK (Ethernet data traffic)

Connection data

Supply

Conductor cross section, flexible	0.20 mm ² ... 2.50 mm ²
Conductor cross section AWG	24 ... 12
Tightening torque	0.5 Nm ... 0.6 Nm

Interfaces

GW MODBUS TCP/RTU 2E/4DB9 - Interface converters



2702767

<https://www.phoenixcontact.com/in/products/2702767>

Signal	Ethernet
	Modbus
Web server	yes

Data: Modbus/TCP

Serial transmission speed	10/100 Mbps, auto negotiation
Connection method	RJ45 jack, shielded
No. of channels	2
Transmission length	≤ 100 m (shielded twisted pair)
Protocols supported	Modbus/RTU, Modbus ASCII, Modbus/TCP
Auxiliary protocols	ARP, DHCP (Client), PING

Data: Modbus RTU / ASCII

Serial transmission speed	0.3; 0.6; 1.2; 2.4; 4.8; 9.6; 19.2; 38.4; 57.6; 115.2; 230.4 Kbps
Number of connections	4
Connection method	D-SUB 9 plug
Pin assignment	DTE
Transmission length	15 m
File format/coding	5/6/7/8 Data bits, 1/2 Stop bits, None/Even/Odd/Mark/Space Parity
Data flow control/protocols	Software handshake, Xon/Xoff or hardware handshake RTS/CTS

Data: Modbus RTU / ASCII

Serial transmission speed	0.3; 0.6; 1.2; 2.4; 4.8; 9.6; 19.2; 38.4; 57.6; 115.2; 230.4 Kbps
Number of connections	4
Connection method	D-SUB 9 plug
Pin assignment	2, 3, 5, 7, 8
Transmission length	≤ 1200 m
Termination resistor	120 Ω (configurable)
File format/coding	5/6/7/8 Data bits, 1/2 Stop bits, None/Even/Odd/Mark/Space Parity

Data: Modbus RTU / ASCII

Serial transmission speed	0.3; 0.6; 1.2; 2.4; 4.8; 9.6; 19.2; 38.4; 57.6; 115.2; 230.4 Kbps
Number of connections	4
Connection method	D-SUB 9 plug
Pin assignment	3, 5, 7
Termination resistor	120 Ω (configurable)
File format/coding	5/6/7/8 Data bits, 1/2 Stop bits, None/Even/Odd/Mark/Space Parity

Dimensions

Width	45 mm
Height	99 mm
Depth	115 mm

Material specifications

GW MODBUS TCP/RTU 2E/4DB9 - Interface converters



2702767

<https://www.phoenixcontact.com/in/products/2702767>

Color	gray
Housing material	PA 6.6

Environmental and real-life conditions

Ambient conditions

Degree of protection	IP20
Ambient temperature (operation)	-40 °C ... 70 °C
Ambient temperature (storage/transport)	-40 °C ... 80 °C
Altitude	< 2000 m
Permissible humidity (operation)	10 % ... 95 % (non-condensing)
Permissible humidity (storage/transport)	5 % ... 95 % (non-condensing)

Approvals

Conformity/Approvals

Conformance	CE-compliant
UL, USA	UL 61010-1
UL, USA / Canada	Class I, Div. 2, Groups A, B, C, D T4A
Noxious gas test	ISA-S71.04-1985 G3 Harsh Group A

Ex data

ATEX	DEMKO 18ATEX 2026X: II 3 G Ex ec IIC T4 Gc
IECEX	IECEX UL 18.0023X Ex ec IIC T4 Gc

EMC data

Noise immunity	EN 61000-6-2:2005
Electromagnetic compatibility	Conformance with EMC Directive 2014/30/EU
Noise emission	EN 61000-6-4

Standards and regulations

Standards/regulations	EN 55022, EN 55024
-----------------------	--------------------

Mounting

Mounting type	DIN rail mounting
---------------	-------------------

GW MODBUS TCP/RTU 2E/4DB9 - Interface converters

2702767

<https://www.phoenixcontact.com/in/products/2702767>

Drawings

Block diagram

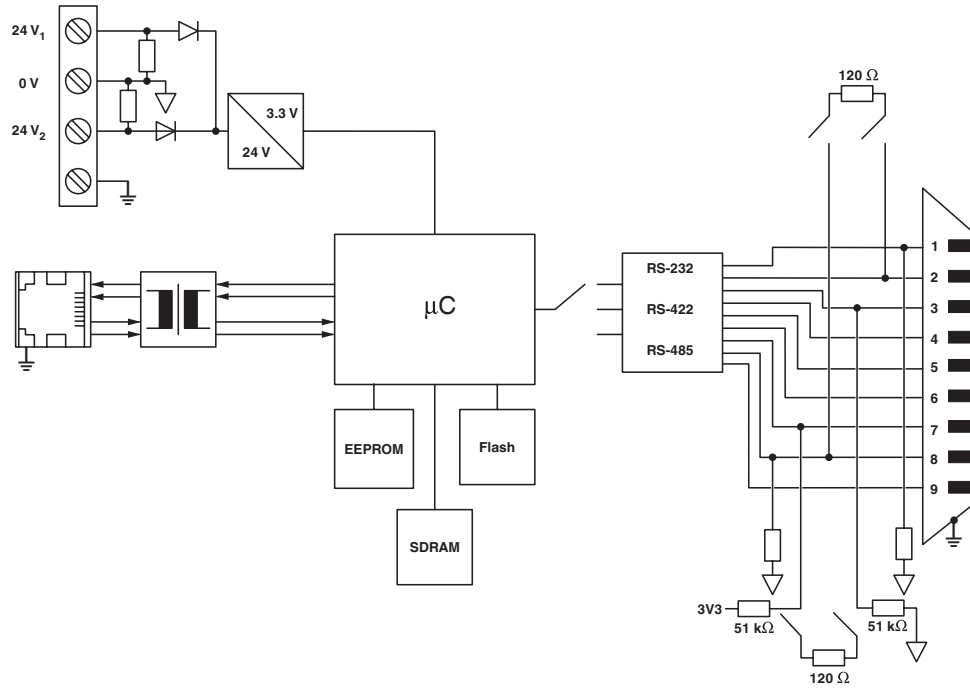

GW MODBUS TCP/RTU 2E/4DB9 - Interface converters





2702767

<https://www.phoenixcontact.com/in/products/2702767>

Approvals

To download certificates, visit the product detail page: <https://www.phoenixcontact.com/in/products/2702767>

 **UL Listed**
Approval ID: E238705

 **cUL Listed**
Approval ID: E238705

 **IECEX**
Approval ID: IECEX UL 18.0023X

 **cUL Listed**
Approval ID: E196811

 **UL Listed**
Approval ID: E196811

 **ATEX**
Approval ID: DEMKO 18 ATEX 2026X

 **IECEX**
Approval ID: IECEX UL 18.0023X

 **ATEX**
Approval ID: DEMKO 18 ATEX 2026X

cULus Listed

cULus Listed

GW MODBUS TCP/RTU 2E/4DB9 - Interface converters



2702767

<https://www.phoenixcontact.com/in/products/2702767>

Classifications

ECLASS

ECLASS-11.0	27242208
ECLASS-12.0	27242208
ECLASS-13.0	27242208

ETIM

ETIM 9.0	EC001423
----------	----------

UNSPSC

UNSPSC 21.0	43222600
-------------	----------

GW MODBUS TCP/RTU 2E/4DB9 - Interface converters



2702767

<https://www.phoenixcontact.com/in/products/2702767>

Environmental product compliance

EU RoHS

Fulfills EU RoHS substance requirements	Yes, No exemptions
---	--------------------

China RoHS

Environment friendly use period (EFUP)	EFUP-50
	An article-related China RoHS declaration table can be found in the download area for the respective article under "Manufacturer declaration". For all articles with EFUP-E, no China RoHS declaration table issued and required.

EU REACH SVHC

REACH candidate substance (CAS No.)	No substance above 0.1 wt%
-------------------------------------	----------------------------

EF3.0 Climate Change

CO2e kg	12.52 kg CO2e
---------	---------------

Phoenix Contact 2024 © - all rights reserved
<https://www.phoenixcontact.com>

PHOENIX CONTACT (I) Pvt. Ltd.
A-58/2, Okhla Industrial Area, Phase - II, New Delhi-110 020

+91.1275.71420
info@phoenixcontact.co.in