

VIP-2/SC/PDM-2/16 - Potential distributors



2315256

<https://www.phoenixcontact.com/in/products/2315256>

Please be informed that the data shown in this PDF document is generated from our Online Catalog. Please find the complete data in the user documentation. Our General Terms of Use for Downloads are valid.



VARIOFACE module, with two equipotential busbars (P1, P2) for potential distribution, for mounting on NS 35 rails. Module width: 50.0 mm

Your advantages

- Consecutive numbering
- Two potential levels
- Separate supply

Commercial Data

Item number	2315256
Packing unit	1 pc
Minimum order quantity	1 pc
Sales Key	CK2
Product Key	CK24D1
Catalog Page	Page 578 (C-5-2019)
GTIN	4046356313360
Weight per Piece (including packing)	117.8 g
Weight per Piece (excluding packing)	116.9 g
Customs tariff number	85369010
Country of origin	US

Technical Data

Notes

General	Polyamide PA non-reinforced, distributor terminal blocks made of PVC
---------	--

Product properties

Product type	Potential distributor
Product family	VARIOFACE Professional
Potential connections	Per potential (P1, P2) 2 power/8 distributor terminal blocks

Insulation characteristics

Overvoltage category	III
Pollution degree	2

Electrical properties

Nominal voltage U_N	250 V AC/DC
Max. current carrying capacity per branch	15 A
Max. total current of all branches	30 A (per potential)
Rated surge voltage	2.2 kV

Input data

Potential connections	Per potential (P1, P2) 2 power/8 distributor terminal blocks
-----------------------	--

Connection data

Service Entrance

Connection method	Screw connection
Stripping length	8 mm
Screw thread	M3
Number of connections	2
Conductor cross section rigid	0.2 mm ² ... 6 mm ²
Conductor cross section flexible	0.2 mm ² ... 4 mm ²
Conductor cross section AWG	24 ... 10

Distribution

Connection method	Screw connection
Stripping length	8 mm
Screw thread	M3
Number of connections	8
Number of positions	2
Conductor cross section rigid	0.2 mm ² ... 4 mm ²
Conductor cross section flexible	0.2 mm ² ... 2.5 mm ²
Conductor cross section AWG	24 ... 12

Dimensions

VIP-2/SC/PDM-2/16 - Potential distributors



2315256

<https://www.phoenixcontact.com/in/products/2315256>

Width	50 mm
Height	65.5 mm
Depth	50 mm

Environmental and real-life conditions

Ambient conditions

Ambient temperature (operation)	-20 °C ... 50 °C (NOTE: At maximum relative humidity < 90%.)
Ambient temperature (storage/transport)	-20 °C ... 70 °C (NOTE: At maximum relative humidity < 90%.)
Altitude	< 2000 m
Permissible humidity (operation)	90 %
Permissible humidity (storage/transport)	90 %

Standards and regulations

Standards/regulations	IEC 60664
	DIN EN 50178

Mounting

Mounting type	DIN rail mounting
Mounting position	any

VIP-2/SC/PDM-2/16 - Potential distributors

2315256

<https://www.phoenixcontact.com/in/products/2315256>



Drawings

Circuit diagram

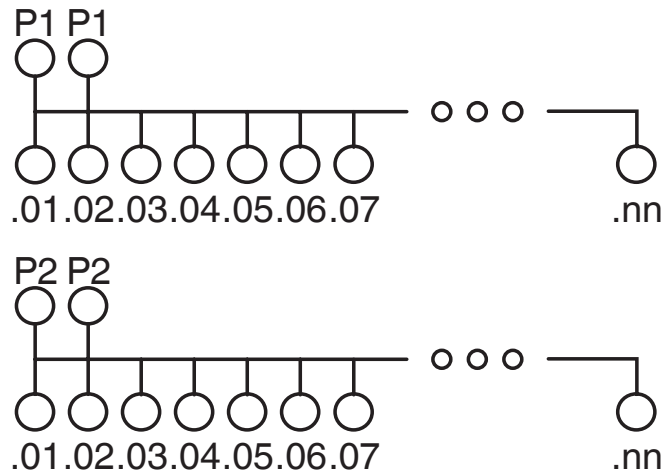

VIP-2/SC/PDM-2/16 - Potential distributors





2315256

<https://www.phoenixcontact.com/in/products/2315256>

Approvals

 CSA Approval ID: 2122203				
	Nominal Voltage U_N	Nominal Current I_N	Cross Section AWG	Cross Section mm^2
Output	250 V	12 A	30 - 12	-
Input	250 V	12 A	30 - 10	-

 cUL Recognized Approval ID: FILE E 238705				
	Nominal Voltage U_N	Nominal Current I_N	Cross Section AWG	Cross Section mm^2
Output	250 V	12 A	30 - 12	-
Input	250 V	12 A	30 - 10	-

 UL Recognized Approval ID: FILE E 238705				
	Nominal Voltage U_N	Nominal Current I_N	Cross Section AWG	Cross Section mm^2
Output	250 V	12 A	30 - 12	-
Input	250 V	12 A	30 - 10	-

 EAC Approval ID: EAC-Zulassung				
--	--	--	--	--

 EAC Approval ID: RU C-DE.BL08.B.00511				
---	--	--	--	--

 CSAus Approval ID: 2122203				
	Nominal Voltage U_N	Nominal Current I_N	Cross Section AWG	Cross Section mm^2
Output	250 V	12 A	30 - 12	-
Input	250 V	12 A	30 - 10	-

VIP-2/SC/PDM-2/16 - Potential distributors



2315256

<https://www.phoenixcontact.com/in/products/2315256>

Classifications

ECLASS

ECLASS-11.0	27400609
ECLASS-12.0	27400609
ECLASS-13.0	27400609

ETIM

ETIM 8.0	EC001894
----------	----------

UNSPSC

UNSPSC 21.0	39121400
-------------	----------

VIP-2/SC/PDM-2/16 - Potential distributors



2315256

<https://www.phoenixcontact.com/in/products/2315256>

Environmental Product Compliance

China RoHS	Environmentally friendly use period: unlimited = EFUP-e
	No hazardous substances above threshold values

Phoenix Contact 2023 © - all rights reserved
<https://www.phoenixcontact.com>

PHOENIX CONTACT (I) Pvt. Ltd.
A-58/2, Okhla Industrial Area, Phase - II, New Delhi-110 020

+91.1275.71420
info@phoenixcontact.co.in