

MC 1,5/ 5-G-3,5 - PCB header



1844249

<https://www.phoenixcontact.com/in/products/1844249>

Please be informed that the data shown in this PDF document is generated from our Online Catalog. Please find the complete data in the user documentation. Our General Terms of Use for Downloads are valid.

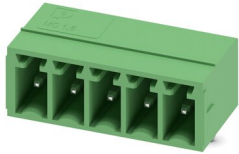

PCB headers, nominal cross section: 1.5 mm², color: green, nominal current: 8 A, rated voltage (III/2): 160 V, contact surface: Tin, type of contact: Pin, number of potentials: 5, number of rows: 1, number of positions: 5, number of connections: 5, product range: MC 1,5/..-G, pitch: 3.5 mm, mounting: Wave soldering, pin layout: Linear pinning, solder pin [P]: 3.4 mm, number of solder pins per potential: 1, plug-in system: COMBICON MC 1,5, Pin connector pattern alignment: Standard, locking: without, mounting: without, type of packaging: packed in cardboard

Your advantages

- Well-known mounting principle allows worldwide use
- Maximum flexibility when it comes to device design – one header for connectors with different connection technologies

Commercial Data

| | |
|--------------------------------------|---------------------|
| Item number | 1844249 |
| Packing unit | 250 pc |
| Minimum order quantity | 250 pc |
| Sales Key | AAB |
| Product Key | AABSAA |
| Catalog Page | Page 224 (C-1-2013) |
| GTIN | 4017918113285 |
| Weight per Piece (including packing) | 1.33 g |
| Weight per Piece (excluding packing) | 1.195 g |
| Customs tariff number | 85366930 |
| Country of origin | IN |

MC 1,5/ 5-G-3,5 - PCB header



1844249

<https://www.phoenixcontact.com/in/products/1844249>

Technical Data

Product properties

| | |
|---------------------------|-----------------------|
| Type | Standard |
| Product line | COMBICON Connectors S |
| Product type | PCB headers |
| Product family | MC 1,5/...-G |
| Number of positions | 5 |
| Pitch | 3.5 mm |
| Number of connections | 5 |
| Number of rows | 1 |
| Mounting flange | without |
| Number of potentials | 5 |
| Pin layout | Linear pinning |
| Solder pins per potential | 1 |

Electrical properties

| | |
|-----------------------------|----------------|
| Nominal current I_N | 8 A |
| Nominal voltage U_N | 160 V |
| Degree of pollution | 3 |
| Contact resistance | 1.3 m Ω |
| Rated voltage (III/3) | 160 V |
| Rated surge voltage (III/3) | 2.5 kV |
| Rated voltage (III/2) | 160 V |
| Rated surge voltage (III/2) | 2.5 kV |
| Rated voltage (II/2) | 250 V |
| Rated surge voltage (II/2) | 2.5 kV |

Mounting

| | |
|-----------------------|----------------|
| Mounting type | Wave soldering |
| Pin layout | Linear pinning |
| Drive form screw head | Slotted |
| Drive form screw head | Slotted |

Material specifications

Material data - contact

| | |
|---|--|
| Note | WEEE/RoHS-compliant, free of whiskers according to IEC 60068-2-82/JEDEC JESD 201 |
| Contact material | Cu alloy |
| Surface characteristics | Tin-plated |
| Metal surface contact area (top layer) | Tin (3 - 5 μm Sn) |
| Metal surface contact area (middle layer) | Nickel (1.3 - 3 μm Ni) |
| Metal surface soldering area (top layer) | Tin (3 - 5 μm Sn) |

MC 1,5/ 5-G-3,5 - PCB header

1844249

<https://www.phoenixcontact.com/in/products/1844249>

| | |
|---|------------------------|
| Metal surface soldering area (middle layer) | Nickel (1.3 - 3 µm Ni) |
|---|------------------------|

Material data - housing

| | |
|--|--------------|
| Color (Housing) | green (6021) |
| Insulating material | PBT |
| Insulating material group | IIIa |
| CTI according to IEC 60112 | 225 |
| Flammability rating according to UL 94 | V0 |

Material data – actuating element

| | |
|----------|----|
| Color () | () |
|----------|----|

Dimensions

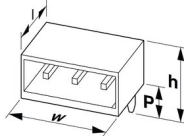
| | |
|-----------------------|---|
| Dimensional drawing |  |
| Pitch | 3.5 mm |
| Width [w] | 18.9 mm |
| Height [h] | 10.65 mm |
| Length [l] | 9.2 mm |
| Installed height | 7.25 mm |
| Solder pin length [P] | 3.4 mm |
| Pin dimensions | 0.80.8 mm |

Mechanical tests

Test for conductor damage and slackening

| | |
|---------------|---------------------|
| Specification | IEC 60999-1:1999-11 |
| Result | Test passed |

Pull-out test

| | |
|---|--|
| Specification | IEC 60999-1:1999-11 |
| Conductor cross section/conductor type/tractive force setpoint/actual value | 0.14 mm ² / solid / > 10 N |
| | 0.14 mm ² / flexible / > 10 N |
| | 1.5 mm ² / solid / > 40 N |
| | 1.5 mm ² / flexible / > 40 N |

Insertion and withdrawal forces

| | |
|-------------------------------------|-------------|
| Result | Test passed |
| No. of cycles | 25 |
| Insertion strength per pos. approx. | 6 N |
| Withdraw strength per pos. approx. | 4 N |

Torque test

MC 1,5/ 5-G-3,5 - PCB header



1844249

<https://www.phoenixcontact.com/in/products/1844249>

| | |
|---|------------------------|
| Specification | IEC 60999-1:1999-11 |
| Contact holder in insert | |
| Specification | IEC 60512-15-1:2008-05 |
| Contact holder in insert Requirements >20 N | Test passed |
| Resistance of inscriptions | |
| Specification | IEC 60068-2-70:1995-12 |
| Result | Test passed |
| Polarization and coding | |
| Specification | IEC 60512-13-5:2006-02 |
| Result | Test passed |
| Visual inspection | |
| Specification | IEC 60512-1-1:2002-02 |
| Result | Test passed |
| Dimension check | |
| Specification | IEC 60512-1-2:2002-02 |
| Result | Test passed |

Electrical tests

Thermal test | Test group C

| | |
|----------------------------|-----------------------|
| Specification | IEC 60512-5-1:2002-02 |
| Tested number of positions | 20 |

Insulation resistance

| | |
|--|-----------------------|
| Specification | IEC 60512-3-1:2002-02 |
| Insulation resistance, neighboring positions | > 5 MΩ |

Air clearances and creepage distances |

| | |
|--|---------------------|
| Specification | IEC 60664-1:2007-04 |
| Insulating material group | IIIa |
| Comparative tracking index (IEC 60112) | CTI 225 |
| Rated insulation voltage (III/3) | 160 V |
| Rated surge voltage (III/3) | 2.5 kV |
| minimum clearance value - non-homogenous field (III/3) | 1.5 mm |
| minimum creepage distance (III/3) | 2.5 mm |
| Rated insulation voltage (III/2) | 160 V |
| Rated surge voltage (III/2) | 2.5 kV |
| minimum clearance value - non-homogenous field (III/2) | 1.5 mm |
| minimum creepage distance (III/2) | 1.6 mm |
| Rated insulation voltage (II/2) | 250 V |
| Rated surge voltage (II/2) | 2.5 kV |
| minimum clearance value - non-homogenous field (II/2) | 1.5 mm |

MC 1,5/ 5-G-3,5 - PCB header



1844249

<https://www.phoenixcontact.com/in/products/1844249>

| | |
|----------------------------------|--------|
| minimum creepage distance (II/2) | 2.5 mm |
|----------------------------------|--------|

Environmental and real-life conditions

Vibration test

| | |
|------------------------|-----------------------------|
| Specification | IEC 60068-2-6:2007-12 |
| Frequency | 10 - 150 - 10 Hz |
| Sweep speed | 1 octave/min |
| Amplitude | 0.35 mm (10 Hz ... 60.1 Hz) |
| Sweep speed | 5g (60.1 Hz ... 150 Hz) |
| Test duration per axis | 2.5 h |

Durability test

| | |
|--|-----------------------|
| Specification | IEC 60512-9-1:2010-03 |
| Impulse withstand voltage at sea level | 2.95 kV |
| Contact resistance R_1 | 1.3 m Ω |
| Contact resistance R_2 | 1.4 m Ω |
| Insertion/withdrawal cycles | 25 |
| Insulation resistance, neighboring positions | > 5 M Ω |

Climatic test

| | |
|-----------------------------------|---|
| Specification | ISO 6988:1985-02 |
| Corrosive stress | 0.2 dm ³ SO ₂ on 300 dm ³ /40 °C/1 cycle |
| Thermal stress | 100 °C/168 h |
| Power-frequency withstand voltage | 1.39 kV |

Ambient conditions

| | |
|---|---|
| Ambient temperature (operation) | -40 °C ... 100 °C (dependent on the derating curve) |
| Ambient temperature (storage/transport) | -40 °C ... 70 °C |
| Relative humidity (storage/transport) | 30 % ... 70 % |
| Ambient temperature (assembly) | -5 °C ... 100 °C |

Packaging specifications

| | |
|-------------------|---------------------|
| Type of packaging | packed in cardboard |
|-------------------|---------------------|

MC 1,5/ 5-G-3,5 - PCB header

1844249

<https://www.phoenixcontact.com/in/products/1844249>

Drawings

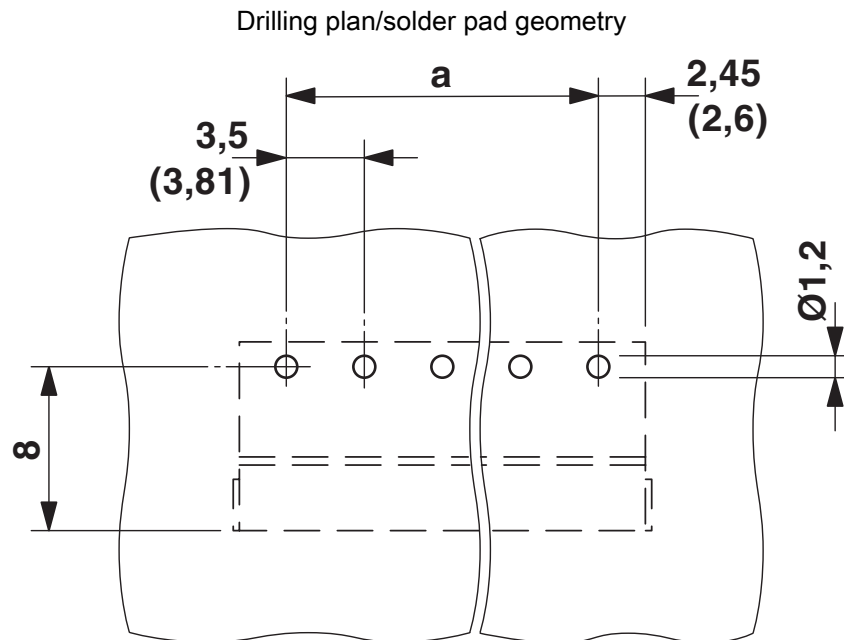

Diagram

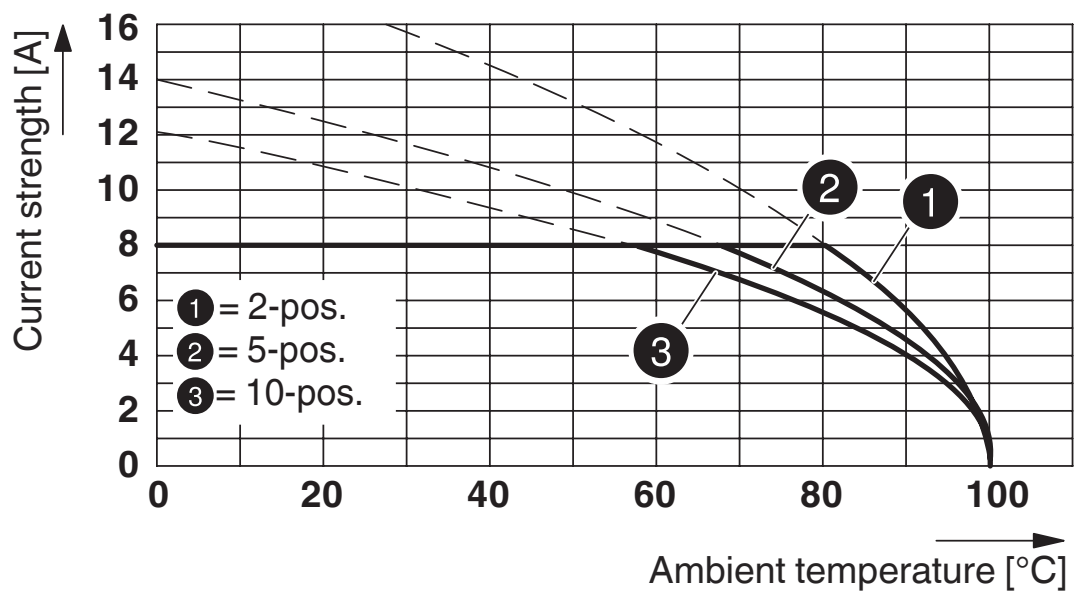

Type: TFMC 1,5/...-ST-3,5 with MC 1,5/...-G-3,5

MC 1,5/ 5-G-3,5 - PCB header

1844249

<https://www.phoenixcontact.com/in/products/1844249>

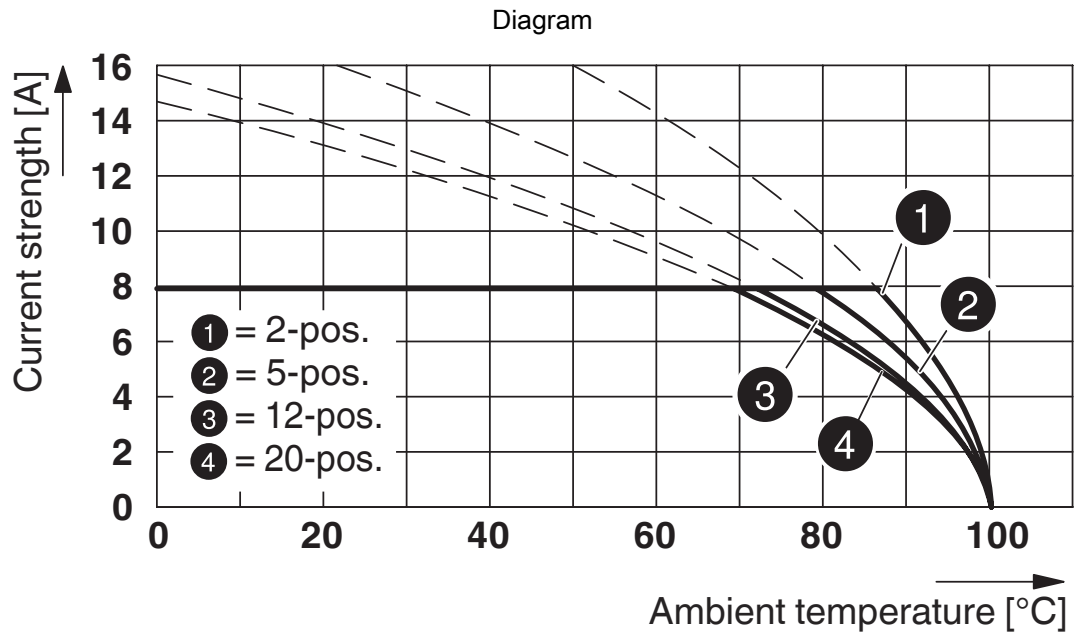

Type: MC 1,5/...-ST-3,5 with MC 1,5/...-G-3,5

Dimensional drawing

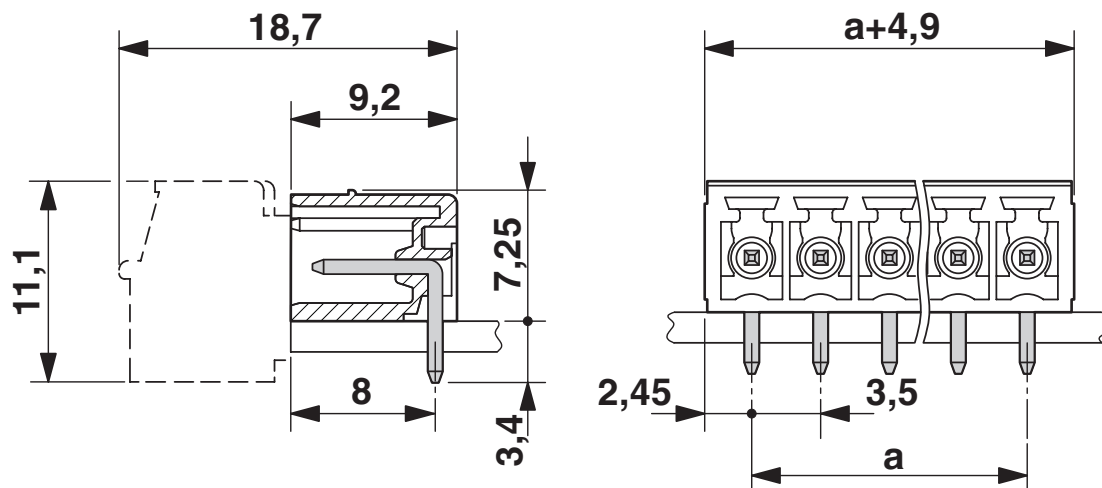

1844249

<https://www.phoenixcontact.com/in/products/1844249>

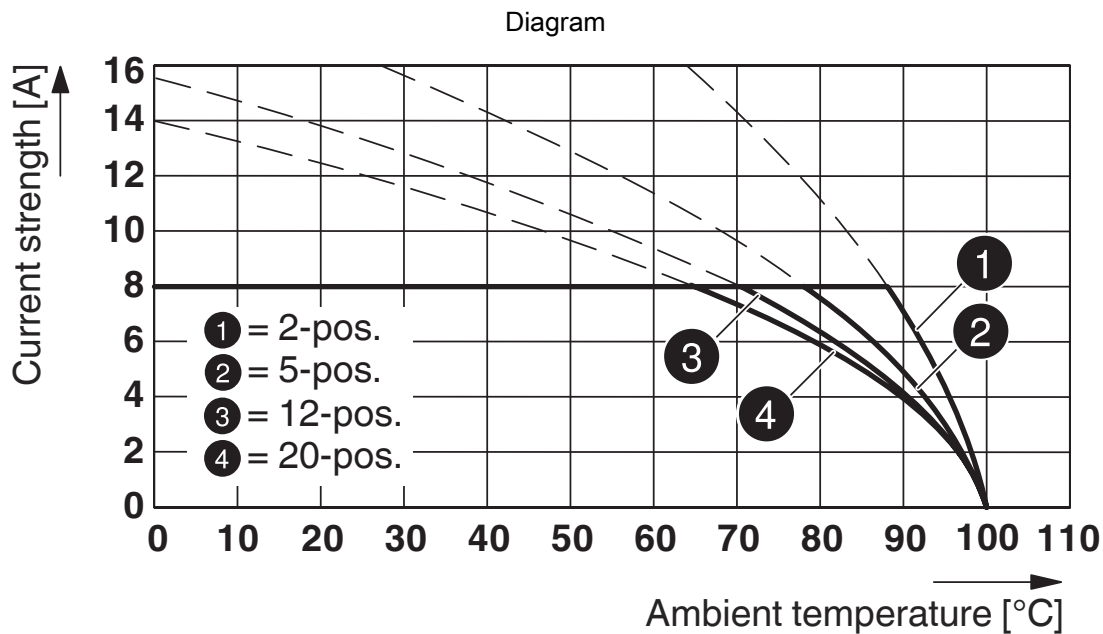

Type: FK-MCP 1,5/...-ST-3,5 with MC 1,5/...-G-3,5

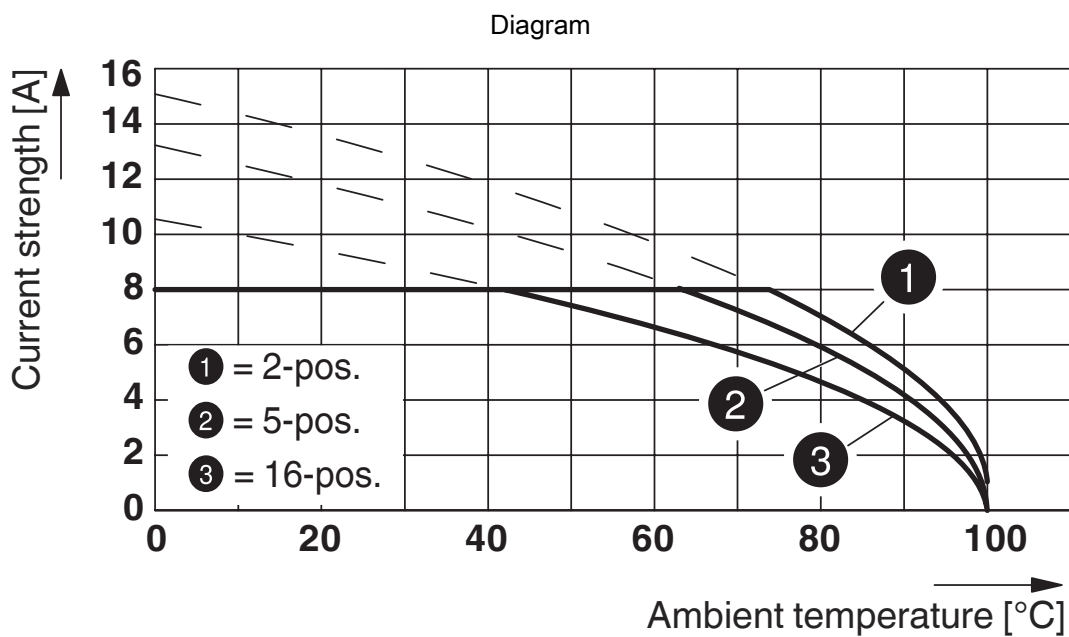

Type: MCVW 1,5/...-ST-3,5 with MC 1,5/...-G-3,5

MC 1,5/ 5-G-3,5 - PCB header



1844249

<https://www.phoenixcontact.com/in/products/1844249>

Approvals

|  CSA Approval ID: 13631 | | | | |
|--|-----------------------|-----------------------|-------------------|-----------------------------|
| | Nominal Voltage U_N | Nominal Current I_N | Cross Section AWG | Cross Section mm^2 |
| | 300 V | 8 A | - | - |
| | 300 V | 8 A | - | - |

|  IECEE CB Scheme Approval ID: DE1-60987-B1B2 | | | | |
|---|-----------------------|-----------------------|-------------------|-----------------------------|
| | Nominal Voltage U_N | Nominal Current I_N | Cross Section AWG | Cross Section mm^2 |
| | 160 V | 8 A | - | - |

|  EAC Approval ID: B.01687 | | | | |
|--|--|--|--|--|
|--|--|--|--|--|

|  cULus Recognized Approval ID: E60425-20110128 | | | | |
|---|-----------------------|-----------------------|-------------------|-----------------------------|
| | Nominal Voltage U_N | Nominal Current I_N | Cross Section AWG | Cross Section mm^2 |
| | 300 V | 8 A | - | - |
| | 300 V | 8 A | - | - |

|  VDE Zeichengenehmigung Approval ID: 40011723 | | | | |
|--|-----------------------|-----------------------|-------------------|-----------------------------|
| | Nominal Voltage U_N | Nominal Current I_N | Cross Section AWG | Cross Section mm^2 |
| | 160 V | 8 A | - | - |

MC 1,5/ 5-G-3,5 - PCB header



1844249

<https://www.phoenixcontact.com/in/products/1844249>

Classifications

ECLASS

| | |
|-------------|----------|
| ECLASS-11.0 | 27460201 |
| ECLASS-12.0 | 27460201 |
| ECLASS-13.0 | 27460201 |

ETIM

| | |
|----------|----------|
| ETIM 8.0 | EC002637 |
|----------|----------|

UNSPSC

| | |
|-------------|----------|
| UNSPSC 21.0 | 39121400 |
|-------------|----------|

MC 1,5/ 5-G-3,5 - PCB header

1844249

<https://www.phoenixcontact.com/in/products/1844249>



Environmental Product Compliance

| | |
|------------|---|
| China RoHS | Environmentally friendly use period: unlimited = EFUP-e |
| | No hazardous substances above threshold values |

MC 1,5/ 5-G-3,5 - PCB header

1844249

<https://www.phoenixcontact.com/in/products/1844249>



Accessories

SK 3,5/2,8:FORTL.ZAHLEN - Marker card

0804073

<https://www.phoenixcontact.com/in/products/0804073>



Marker card, white, labeled, horizontal: consecutive numbers 1 ... 10, 11 ... 20, etc. up to 91 ... 99, mounting type: adhesive, for terminal block width: 3.5 mm, lettering field size: 3.5 x 2.8 mm

CP-MSTB - Coding profile

1734634

<https://www.phoenixcontact.com/in/products/1734634>



Coding profile, is inserted into the slot on the plug or inverted header, red insulating material

MC 1,5/ 5-G-3,5 - PCB header

1844249

<https://www.phoenixcontact.com/in/products/1844249>



MC 1,5/10-LWL 1,5-3,5 - Fiber optic

1841161

<https://www.phoenixcontact.com/in/products/1841161>

MINI COMBICON fiber optics, 3.5 mm pitch, 10-pos., separable for other numbers of positions (minimum: 2-pos.), inserts into the back of the MC header, color: transparent, dimension a: 1.5 mm



MC 1,5/10-LWL 2,3-3,5 - Fiber optic

1841187

<https://www.phoenixcontact.com/in/products/1841187>

MINI COMBICON fiber optics, 3.5 mm pitch, 10-pos., separable for other numbers of positions (minimum: 2-pos.), inserts into the back of the MC header, color: transparent, dimension a: 2.3 mm



MC 1,5/ 5-G-3,5 - PCB header

1844249

<https://www.phoenixcontact.com/in/products/1844249>



MC 1,5/10-LWL 4-3,5 - Fiber optic

1841200

<https://www.phoenixcontact.com/in/products/1841200>

MINI COMBICON fiber optics, 3.5 mm pitch, 10-pos., separable for other numbers of positions (minimum: 2-pos.), inserts into the back of the MC header, color: transparent, dimension a: 4 mm



MC 1,5/ 5-ST-3,5 GY7035 - PCB connector

1769087

<https://www.phoenixcontact.com/in/products/1769087>



PCB connector, nominal cross section: 1.5 mm², color: light grey, nominal current: 8 A, rated voltage (III/2): 160 V, contact surface: Tin, type of contact: Socket, number of potentials: 5, number of rows: 1, number of positions: 5, number of connections: 5, product range: MC 1,5/...-ST, pitch: 3.5 mm, connection method: Screw connection with tension sleeve, screw head form: L Slotted, conductor/PCB connection direction: 0 °, plug-in system: COMBICON MC 1,5, locking: without, mounting: without, type of packaging: packed in cardboard

MC 1,5/ 5-G-3,5 - PCB header

1844249

<https://www.phoenixcontact.com/in/products/1844249>



TFMC 1,5/ 5-ST-3,5 - Printed-circuit board connector

1772647

<https://www.phoenixcontact.com/in/products/1772647>

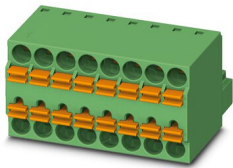

PCB connector, nominal cross section: 1.5 mm², color: green, nominal current: 8 A, rated voltage (III/2): 160 V, contact surface: Tin, type of contact: Socket, number of potentials: 5, number of rows: 1, number of positions: 5, number of connections: 10, product range: TFMC 1,5/...-ST, pitch: 3.5 mm, connection method: Push-in spring connection, conductor/PCB connection direction: 0 °, plug-in system: COMBICON MC 1,5, locking: without, mounting: without, type of packaging: packed in cardboard

MC 1,5/ 5-ST-3,5 - PCB connector

1840395

<https://www.phoenixcontact.com/in/products/1840395>

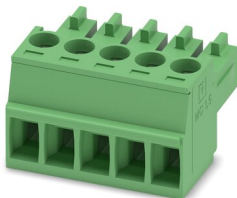

PCB connector, nominal cross section: 1.5 mm², color: green, nominal current: 8 A, rated voltage (III/2): 160 V, contact surface: Tin, type of contact: Socket, number of potentials: 5, number of rows: 1, number of positions: 5, number of connections: 5, product range: MC 1,5/...-ST, pitch: 3.5 mm, connection method: Screw connection with tension sleeve, screw head form: L Slotted, conductor/PCB connection direction: 0 °, plug-in system: COMBICON MC 1,5, locking: without, mounting: without, type of packaging: packed in cardboard

MC 1,5/ 5-G-3,5 - PCB header

1844249

<https://www.phoenixcontact.com/in/products/1844249>



MCVW 1,5/ 5-ST-3,5 - PCB connector

1862881

<https://www.phoenixcontact.com/in/products/1862881>



PCB connector, nominal cross section: 1.5 mm², color: green, nominal current: 8 A, rated voltage (III/2): 160 V, contact surface: Tin, type of contact: Socket, number of potentials: 5, number of rows: 1, number of positions: 5, number of connections: 5, product range: MCVW 1,5/..-ST, pitch: 3.5 mm, connection method: Screw connection with tension sleeve, screw head form: L Slotted, conductor/PCB connection direction: -90 °, plug-in system: COMBICON MC 1,5, locking: without, mounting: without, type of packaging: packed in cardboard

MCVR 1,5/ 5-ST-3,5 - PCB connector

1863181

<https://www.phoenixcontact.com/in/products/1863181>

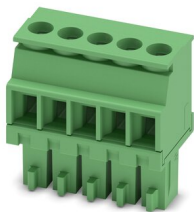

PCB connector, nominal cross section: 1.5 mm², color: green, nominal current: 8 A, rated voltage (III/2): 160 V, contact surface: Tin, type of contact: Socket, number of potentials: 5, number of rows: 1, number of positions: 5, number of connections: 5, product range: MCVR 1,5/..-ST, pitch: 3.5 mm, connection method: Screw connection with tension sleeve, screw head form: L Slotted, conductor/PCB connection direction: 90 °, plug-in system: COMBICON MC 1,5, locking: without, mounting: without, type of packaging: packed in cardboard

MC 1,5/ 5-G-3,5 - PCB header

1844249

<https://www.phoenixcontact.com/in/products/1844249>



FK-MCP 1,5/ 5-ST-3,5 - PCB connector

1939947

<https://www.phoenixcontact.com/in/products/1939947>

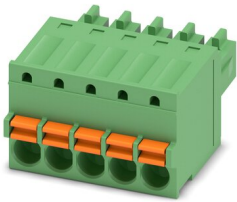

PCB connector, nominal cross section: 1.5 mm², color: green, nominal current: 8 A, rated voltage (III/2): 160 V, contact surface: Tin, type of contact: Socket, number of potentials: 5, number of rows: 1, number of positions: 5, number of connections: 5, product range: FK-MCP 1,5/..-ST, pitch: 3.5 mm, connection method: Push-in spring connection, conductor/PCB connection direction: 0 °, plug-in system: COMBICON MC 1,5, locking: without, mounting: without, type of packaging: packed in cardboard

FMC 1,5/ 5-ST-3,5 - Printed-circuit board connector

1952296

<https://www.phoenixcontact.com/in/products/1952296>

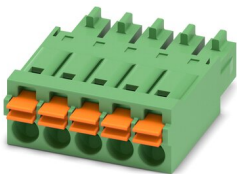

PCB connector, nominal cross section: 1.5 mm², color: green, nominal current: 8 A, rated voltage (III/2): 160 V, contact surface: Tin, type of contact: Socket, number of potentials: 5, number of rows: 1, number of positions: 5, number of connections: 5, product range: FMC 1,5/..-ST, pitch: 3.5 mm, connection method: Push-in spring connection, conductor/PCB connection direction: 0 °, plug-in system: COMBICON MC 1,5, locking: without, mounting: without, type of packaging: packed in cardboard

MC 1,5/ 5-G-3,5 - PCB header

1844249

<https://www.phoenixcontact.com/in/products/1844249>



XPC 1,5/ 5-ST-3,5 BK - PCB connector

1464108

<https://www.phoenixcontact.com/in/products/1464108>



PCB connector, nominal cross section: 1.5 mm², color: black, nominal current: 8 A, rated voltage (III/2): 160 V, contact surface: Tin, type of contact: Socket, number of rows: 1, number of positions: 5, product range: XPC 1,5/..-ST, pitch: 3.5 mm, connection method: Push-X-connection, conductor/PCB connection direction: 0 °, locking clip: - without locking clip, plug-in system: COMBICON MC 1,5, locking: without, mounting: without, type of packaging: packed in cardboard

Phoenix Contact 2023 © - all rights reserved

<https://www.phoenixcontact.com>

PHOENIX CONTACT (I) Pvt. Ltd.

A-58/2, Okhla Industrial Area, Phase - II, New Delhi-110 020

+91.1275.71420

info@phoenixcontact.co.in