

MCV 1,5/ 2-G-3,81 - PCB header



1803426

<https://www.phoenixcontact.com/in/products/1803426>

Please be informed that the data shown in this PDF document is generated from our Online Catalog. Please find the complete data in the user documentation. Our General Terms of Use for Downloads are valid.

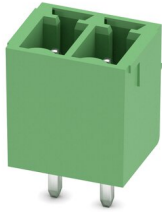

PCB headers, nominal cross section: 1.5 mm², color: green, nominal current: 8 A, rated voltage (III/2): 160 V, contact surface: Tin, type of contact: Pin, number of potentials: 2, number of rows: 1, number of positions: 2, number of connections: 2, product range: MCV 1,5/..-G, pitch: 3.81 mm, mounting: Wave soldering, pin layout: Linear pinning, solder pin [P]: 3.4 mm, number of solder pins per potential: 1, plug-in system: COMBICON MC 1,5, Pin connector pattern alignment: Standard, locking: without, mounting: without, type of packaging: packed in cardboard

Your advantages

- Well-known mounting principle allows worldwide use
- Vertical connection enables multi-row arrangement on the PCB
- Maximum flexibility when it comes to device design – one header for connectors with different connection technologies

Commercial Data

| | |
|--------------------------------------|---------------------|
| Item number | 1803426 |
| Packing unit | 250 pc |
| Minimum order quantity | 250 pc |
| Sales Key | AAB |
| Product Key | AABSBE |
| Catalog Page | Page 226 (C-1-2013) |
| GTIN | 4017918045739 |
| Weight per Piece (including packing) | 0.646 g |
| Weight per Piece (excluding packing) | 0.646 g |
| Customs tariff number | 85366930 |
| Country of origin | IN |

MCV 1,5/ 2-G-3,81 - PCB header



1803426

<https://www.phoenixcontact.com/in/products/1803426>

Technical Data

Product properties

| | |
|---------------------------|-----------------------|
| Type | Standard |
| Product line | COMBICON Connectors S |
| Product type | PCB headers |
| Product family | MCV 1,5/..-G |
| Number of positions | 2 |
| Pitch | 3.81 mm |
| Number of connections | 2 |
| Number of rows | 1 |
| Mounting flange | without |
| Number of potentials | 2 |
| Pin layout | Linear pinning |
| Solder pins per potential | 1 |

Electrical properties

| | |
|-----------------------------|----------------|
| Nominal current I_N | 8 A |
| Nominal voltage U_N | 160 V |
| Degree of pollution | 3 |
| Contact resistance | 1.2 m Ω |
| Rated voltage (III/3) | 160 V |
| Rated surge voltage (III/3) | 2.5 kV |
| Rated voltage (III/2) | 160 V |
| Rated surge voltage (III/2) | 2.5 kV |
| Rated voltage (II/2) | 250 V |
| Rated surge voltage (II/2) | 2.5 kV |

Mounting

| | |
|---------------|----------------|
| Mounting type | Wave soldering |
| Pin layout | Linear pinning |

Material specifications

Material data - contact

| | |
|---|--|
| Note | WEEE/RoHS-compliant, free of whiskers according to IEC 60068-2-82/JEDEC JESD 201 |
| Contact material | Cu alloy |
| Surface characteristics | Tin-plated |
| Metal surface contact area (top layer) | Tin (3 - 5 μm Sn) |
| Metal surface contact area (middle layer) | Nickel (1 - 3 μm Ni) |
| Metal surface soldering area (top layer) | Tin (3 - 5 μm Sn) |
| Metal surface soldering area (middle layer) | Nickel (1 - 3 μm Ni) |

Material data - housing

MCV 1,5/ 2-G-3,81 - PCB header

1803426

<https://www.phoenixcontact.com/in/products/1803426>

| | |
|--|--------------|
| Color (Housing) | green (6021) |
| Insulating material | PBT |
| Insulating material group | IIIa |
| CTI according to IEC 60112 | 225 |
| Flammability rating according to UL 94 | V0 |

Material data – actuating element

| | |
|-----------|-----|
| Color () | () |
|-----------|-----|

Dimensions

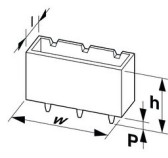
| | |
|-----------------------|--|
| Dimensional drawing |  |
| Pitch | 3.81 mm |
| Width [w] | 9.01 mm |
| Height [h] | 12.6 mm |
| Length [l] | 7.25 mm |
| Installed height | 9.2 mm |
| Solder pin length [P] | 3.4 mm |

Mechanical tests

Test for conductor damage and slackening

| | |
|---------------|---------------------|
| Specification | IEC 60999-1:1999-11 |
| Result | Test passed |

Pull-out test

| | |
|---|--|
| Specification | IEC 60999-1:1999-11 |
| Conductor cross section/conductor type/tractive force setpoint/actual value | 0.14 mm ² / solid / > 10 N |
| | 0.14 mm ² / flexible / > 10 N |
| | 1.5 mm ² / solid / > 40 N |
| | 1.5 mm ² / flexible / > 40 N |

Insertion and withdrawal forces

| | |
|-------------------------------------|-------------|
| Result | Test passed |
| No. of cycles | 25 |
| Insertion strength per pos. approx. | 8 N |
| Withdraw strength per pos. approx. | 6 N |

Torque test

| | |
|---------------|---------------------|
| Specification | IEC 60999-1:1999-11 |
|---------------|---------------------|

Contact holder in insert

| | |
|---------------|------------------------|
| Specification | IEC 60512-15-1:2008-05 |
|---------------|------------------------|

MCV 1,5/ 2-G-3,81 - PCB header



1803426

<https://www.phoenixcontact.com/in/products/1803426>

| | |
|--|------------------------|
| Contact holder in insert Requirements >20 N | Test passed |
| Resistance of inscriptions | |
| Specification | IEC 60068-2-70:1995-12 |
| Result | Test passed |
| Polarization and coding | |
| Specification | IEC 60512-13-5:2006-02 |
| Result | Test passed |
| Visual inspection | |
| Specification | IEC 60512-1-1:2002-02 |
| Result | Test passed |
| Dimension check | |
| Specification | IEC 60512-1-2:2002-02 |
| Result | Test passed |

Electrical tests

Thermal test | Test group C

| | |
|----------------------------|-----------------------|
| Specification | IEC 60512-5-1:2002-02 |
| Tested number of positions | 20 |

Insulation resistance

| | |
|--|-----------------------|
| Specification | IEC 60512-3-1:2002-02 |
| Insulation resistance, neighboring positions | > 5 MΩ |

Air clearances and creepage distances |

| | |
|--|---------------------|
| Specification | IEC 60664-1:2007-04 |
| Insulating material group | IIIa |
| Comparative tracking index (IEC 60112) | CTI 225 |
| Rated insulation voltage (III/3) | 160 V |
| Rated surge voltage (III/3) | 2.5 kV |
| minimum clearance value - non-homogenous field (III/3) | 1.5 mm |
| minimum creepage distance (III/3) | 2.5 mm |
| Rated insulation voltage (III/2) | 160 V |
| Rated surge voltage (III/2) | 2.5 kV |
| minimum clearance value - non-homogenous field (III/2) | 1.5 mm |
| minimum creepage distance (III/2) | 1.6 mm |
| Rated insulation voltage (II/2) | 250 V |
| Rated surge voltage (II/2) | 2.5 kV |
| minimum clearance value - non-homogenous field (II/2) | 1.5 mm |
| minimum creepage distance (II/2) | 2.5 mm |

Environmental and real-life conditions

MCV 1,5/ 2-G-3,81 - PCB header



1803426

<https://www.phoenixcontact.com/in/products/1803426>

Vibration test

| | |
|------------------------|-----------------------------|
| Specification | IEC 60068-2-6:2007-12 |
| Frequency | 10 - 150 - 10 Hz |
| Sweep speed | 1 octave/min |
| Amplitude | 0.35 mm (10 Hz ... 60.1 Hz) |
| Sweep speed | 5g (60.1 Hz ... 150 Hz) |
| Test duration per axis | 2.5 h |

Durability test

| | |
|--|-----------------------|
| Specification | IEC 60512-9-1:2010-03 |
| Impulse withstand voltage at sea level | 2.95 kV |
| Contact resistance R ₁ | 1.2 mΩ |
| Contact resistance R ₂ | 1.2 mΩ |
| Insertion/withdrawal cycles | 25 |
| Insulation resistance, neighboring positions | > 5 MΩ |

Climatic test

| | |
|-----------------------------------|---|
| Specification | ISO 6988:1985-02 |
| Corrosive stress | 0.2 dm ³ SO ₂ on 300 dm ³ /40 °C/1 cycle |
| Thermal stress | 100 °C/168 h |
| Power-frequency withstand voltage | 1.39 kV |

Ambient conditions

| | |
|---|---|
| Ambient temperature (operation) | -40 °C ... 100 °C (dependent on the derating curve) |
| Ambient temperature (storage/transport) | -40 °C ... 70 °C |
| Relative humidity (storage/transport) | 30 % ... 70 % |
| Ambient temperature (assembly) | -5 °C ... 100 °C |

Packaging specifications

| | |
|-------------------|---------------------|
| Type of packaging | packed in cardboard |
|-------------------|---------------------|

Drawings

Diagram

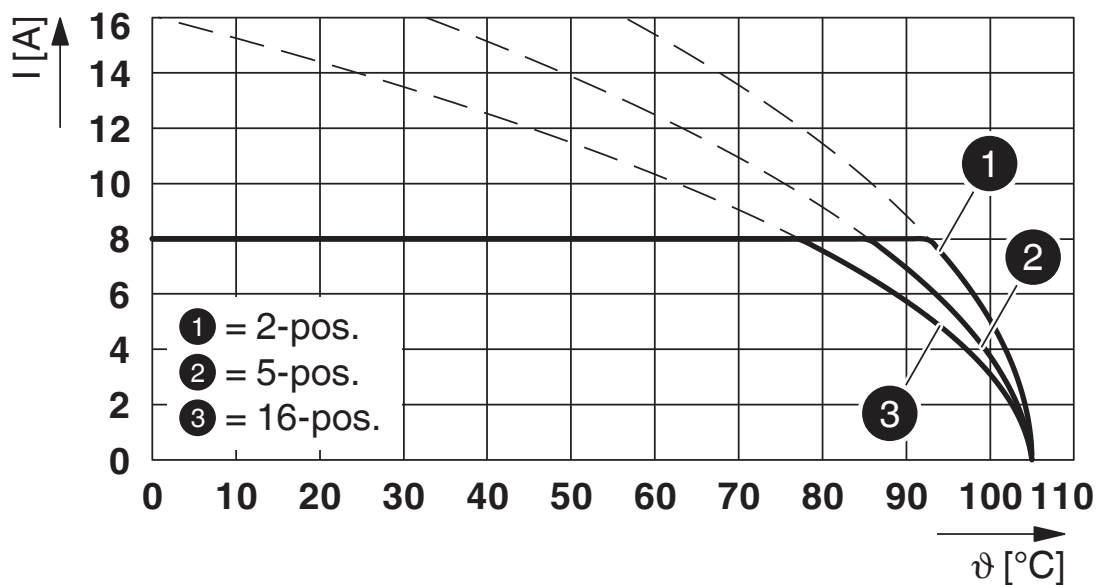

Type: LPC 1,5/...-ST-3,81 with MCV 1,5/...-G-3,81

Diagram

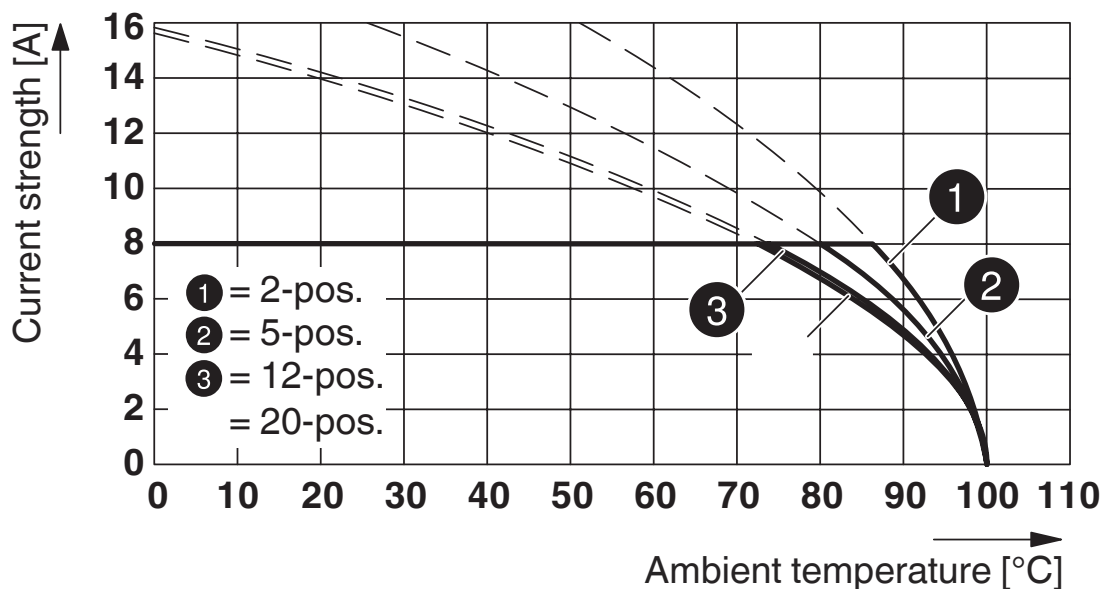

Type: FK-MCP 1,5/...-ST-3,81 with MCV 1,5/...-G-3,81

MCV 1,5/ 2-G-3,81 - PCB header

1803426

<https://www.phoenixcontact.com/in/products/1803426>

Diagram

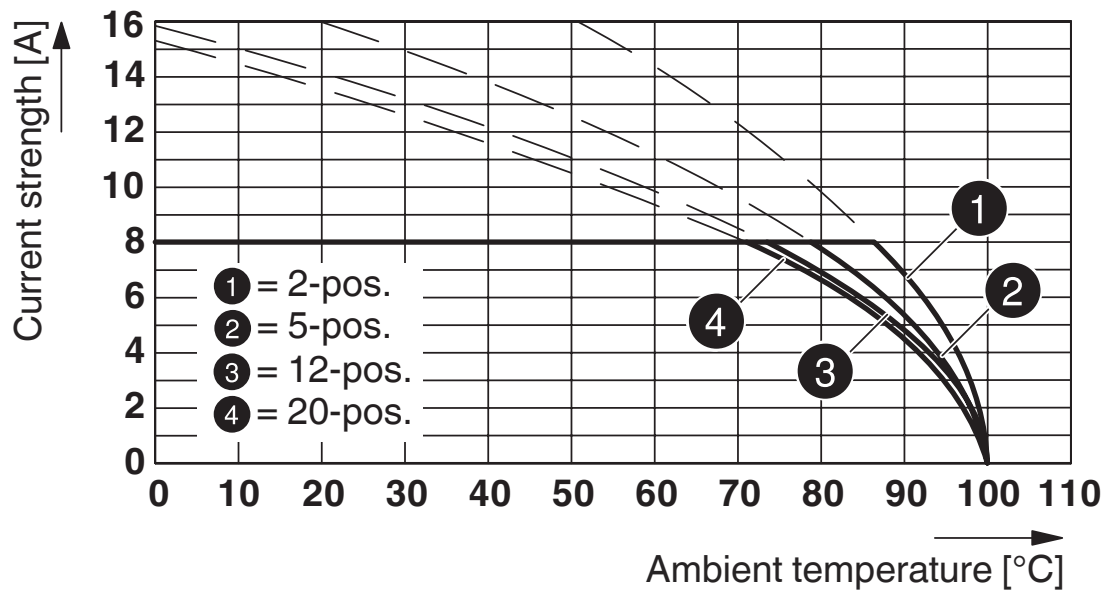

Type: FRONT-MC 1,5/...-ST-3,81 with MCV 1,5/...-G-3,81

Dimensional drawing

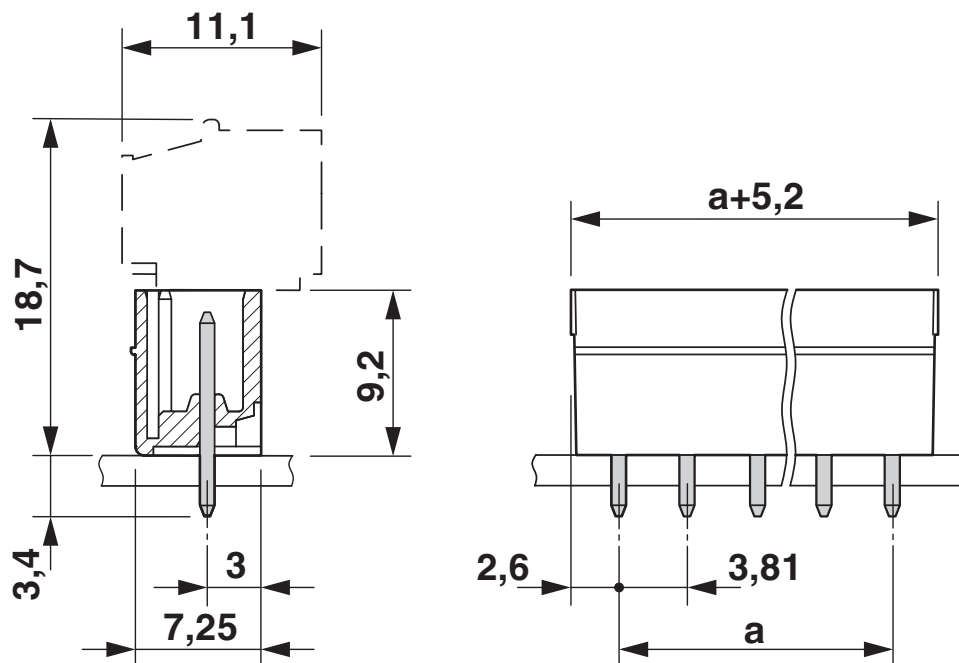

MCV 1,5/ 2-G-3,81 - PCB header



1803426

<https://www.phoenixcontact.com/in/products/1803426>

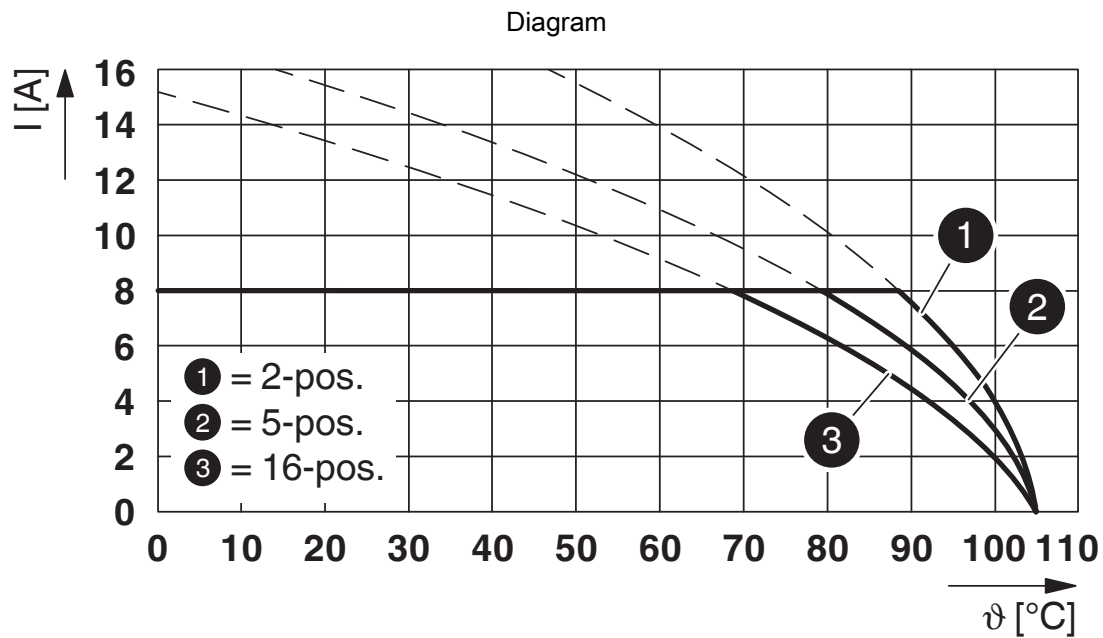

Type: IMC 1,5/...-G-3,81 with MCV 1,5/...-G-3,81

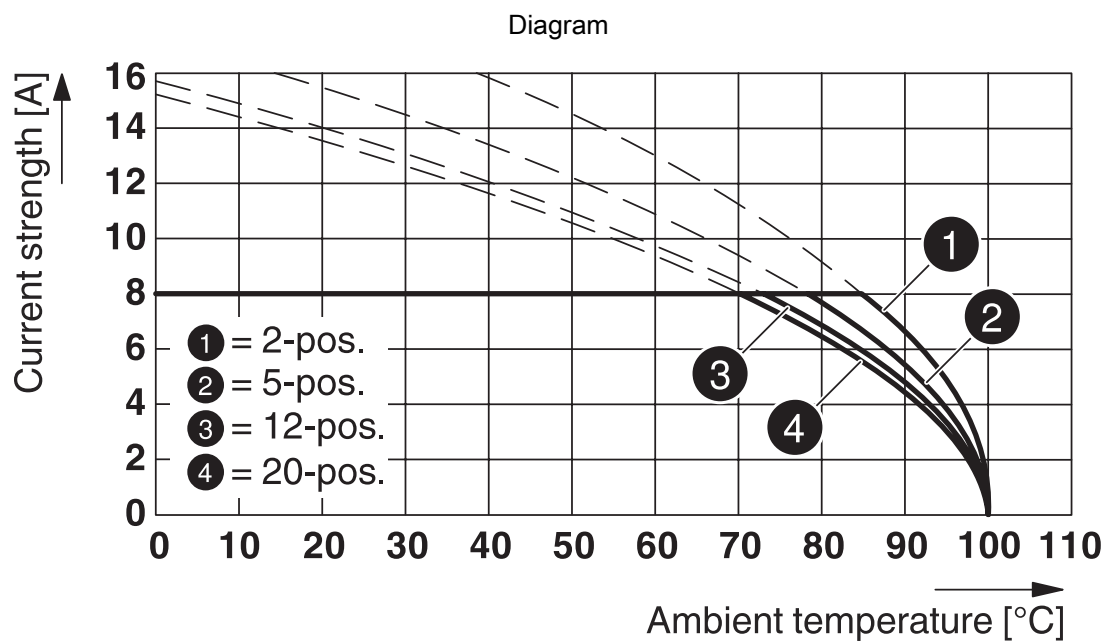

Type: FMC 1,5/...-ST-3,81 with MCV 1,5/...-G-3,81

MCV 1,5/ 2-G-3,81 - PCB header

1803426

<https://www.phoenixcontact.com/in/products/1803426>

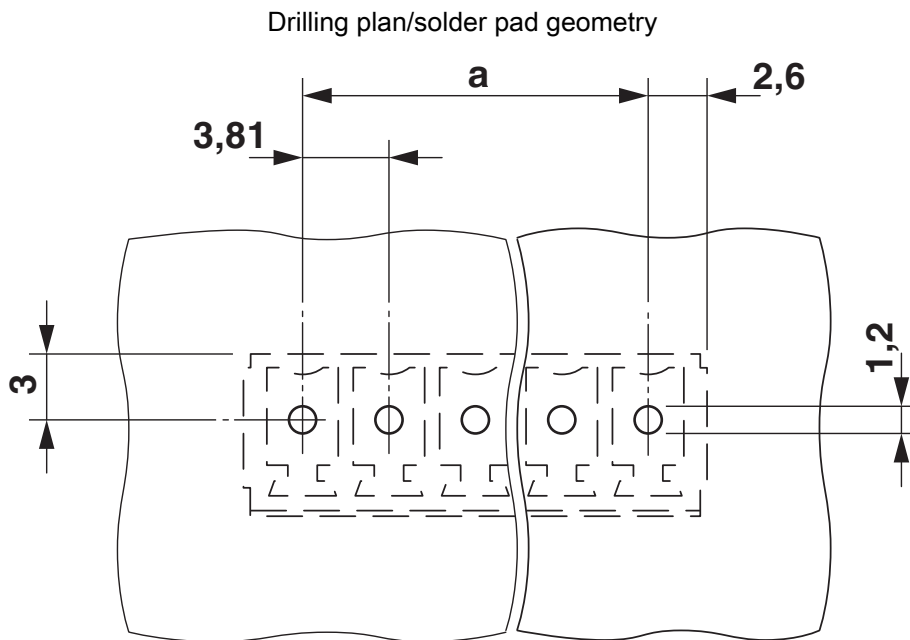

Diagram

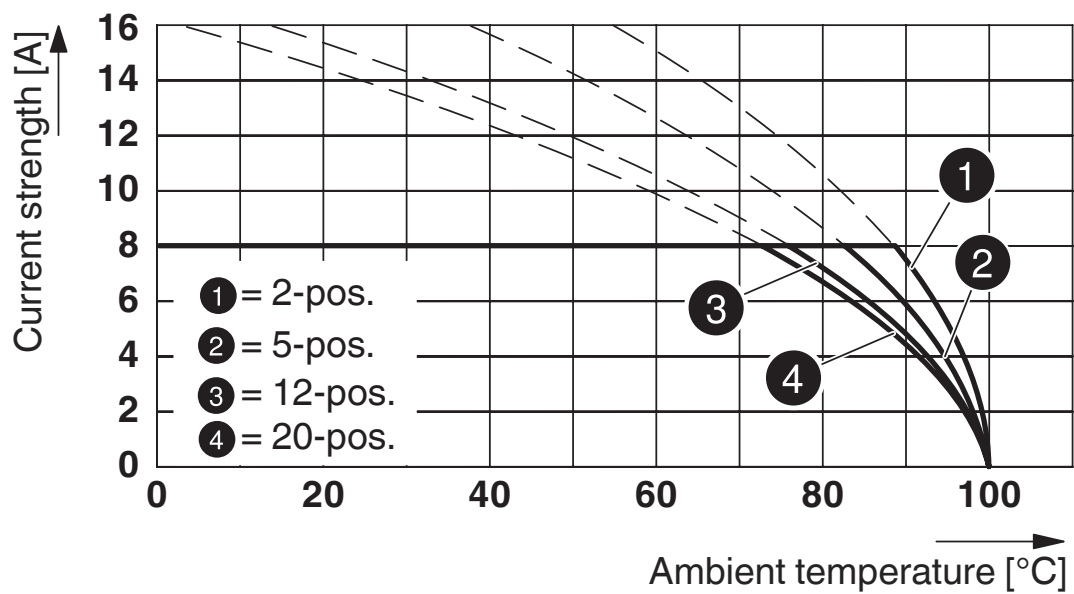

Type: MC 1,5/...-ST-3,81 with MCV 1,5/...-G-3,81

MCV 1,5/ 2-G-3,81 - PCB header



1803426

<https://www.phoenixcontact.com/in/products/1803426>

Approvals

|  CSA Approval ID: 13631 | | | | |
|--|-----------------------|-----------------------|-------------------|-----------------------------|
| | Nominal Voltage U_N | Nominal Current I_N | Cross Section AWG | Cross Section mm^2 |
| Use group B | 300 V | 8 A | - | - |
| Use group D | 300 V | 8 A | - | - |

|  IECEE CB Scheme Approval ID: DE1-60987-B1B2 | | | | |
|---|-----------------------|-----------------------|-------------------|-----------------------------|
| | Nominal Voltage U_N | Nominal Current I_N | Cross Section AWG | Cross Section mm^2 |
| | 160 V | 8 A | - | - |

|  EAC Approval ID: B.01687 | | | | |
|--|--|--|--|--|
|--|--|--|--|--|

|  cULus Recognized Approval ID: E60425-20110128 | | | | |
|---|-----------------------|-----------------------|-------------------|-----------------------------|
| | Nominal Voltage U_N | Nominal Current I_N | Cross Section AWG | Cross Section mm^2 |
| Use group B | 300 V | 8 A | - | - |
| Use group D | 300 V | 8 A | - | - |

|  VDE Zeichengenehmigung Approval ID: 40011723 | | | | |
|--|-----------------------|-----------------------|-------------------|-----------------------------|
| | Nominal Voltage U_N | Nominal Current I_N | Cross Section AWG | Cross Section mm^2 |
| | 160 V | 8 A | - | - |

MCV 1,5/ 2-G-3,81 - PCB header



1803426

<https://www.phoenixcontact.com/in/products/1803426>

Classifications

ECLASS

| | |
|-------------|----------|
| ECLASS-11.0 | 27460201 |
| ECLASS-12.0 | 27460201 |
| ECLASS-13.0 | 27460201 |

ETIM

| | |
|----------|----------|
| ETIM 8.0 | EC002637 |
|----------|----------|

UNSPSC

| | |
|-------------|----------|
| UNSPSC 21.0 | 39121400 |
|-------------|----------|

MCV 1,5/ 2-G-3,81 - PCB header

1803426

<https://www.phoenixcontact.com/in/products/1803426>



Environmental Product Compliance

China RoHS

Environmentally friendly use period: unlimited = EFUP-e

No hazardous substances above threshold values

MCV 1,5/ 2-G-3,81 - PCB header

1803426

<https://www.phoenixcontact.com/in/products/1803426>



Accessories

SK 3,81/2,8:FORTL.ZAHLEN - Marker card

0804109

<https://www.phoenixcontact.com/in/products/0804109>

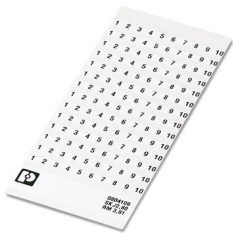

Marker card, white, labeled, horizontal: consecutive numbers 1 ... 10, 11 ... 20, etc. up to 91 ... (99)100, mounting type: adhesive, for terminal block width: 3.81 mm, lettering field size: 3.81 x 2.8 mm

CP-MSTB - Coding profile

1734634

<https://www.phoenixcontact.com/in/products/1734634>



Coding profile, is inserted into the slot on the plug or inverted header, red insulating material

MCV 1,5/ 2-G-3,81 - PCB header

1803426

<https://www.phoenixcontact.com/in/products/1803426>



B-STIFT - Marker pen

1051993

<https://www.phoenixcontact.com/in/products/1051993>



Marker pen, for manual labeling of unprinted Zack strips, smear-proof and waterproof, line thickness 0.5 mm

FMC 1,5/ 2-ST-3,81 - Printed-circuit board connector

1745894

<https://www.phoenixcontact.com/in/products/1745894>

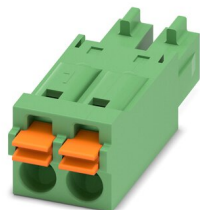

PCB connector, nominal cross section: 1.5 mm², color: green, nominal current: 8 A, rated voltage (III/2): 160 V, contact surface: Tin, type of contact: Socket, number of potentials: 2, number of rows: 1, number of positions: 2, number of connections: 2, product range: FMC 1,5/..-ST, pitch: 3.81 mm, connection method: Push-in spring connection, conductor/PCB connection direction: 0 °, plug-in system: COMBICON MC 1,5, locking: without, mounting: without, type of packaging: packed in cardboard

MCV 1,5/ 2-G-3,81 - PCB header

1803426

<https://www.phoenixcontact.com/in/products/1803426>



MC 1,5/ 2-ST-3,81 - PCB connector

1803578

<https://www.phoenixcontact.com/in/products/1803578>

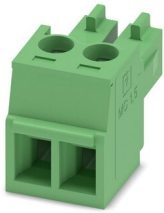

PCB connector, nominal cross section: 1.5 mm², color: green, nominal current: 8 A, rated voltage (III/2): 160 V, contact surface: Tin, type of contact: Socket, number of potentials: 2, number of rows: 1, number of positions: 2, number of connections: 2, product range: MC 1,5/..-ST, pitch: 3.81 mm, connection method: Screw connection with tension sleeve, screw head form: L Slotted, conductor/PCB connection direction: 0 °, plug-in system: COMBICON MC 1,5, locking: without, mounting: without, type of packaging: packed in cardboard

MCVW 1,5/ 2-ST-3,81 - PCB connector

1826979

<https://www.phoenixcontact.com/in/products/1826979>



PCB connector, nominal cross section: 1.5 mm², color: green, nominal current: 8 A, rated voltage (III/2): 160 V, contact surface: Tin, type of contact: Socket, number of potentials: 2, number of rows: 1, number of positions: 2, number of connections: 2, product range: MCVW 1,5/..-ST, pitch: 3.81 mm, connection method: Screw connection with tension sleeve, screw head form: L Slotted, conductor/PCB connection direction: -90 °, plug-in system: COMBICON MC 1,5, locking: without, mounting: without, type of packaging: packed in cardboard

MCV 1,5/ 2-G-3,81 - PCB header

1803426

<https://www.phoenixcontact.com/in/products/1803426>



MCVR 1,5/ 2-ST-3,81 - PCB connector

1827127

<https://www.phoenixcontact.com/in/products/1827127>



PCB connector, nominal cross section: 1.5 mm², color: green, nominal current: 8 A, rated voltage (III/2): 160 V, contact surface: Tin, type of contact: Socket, number of potentials: 2, number of rows: 1, number of positions: 2, number of connections: 2, product range: MCVR 1,5/..-ST, pitch: 3.81 mm, connection method: Screw connection with tension sleeve, screw head form: L Slotted, conductor/PCB connection direction: 90 °, plug-in system: COMBICON MC 1,5, locking: without, mounting: without, type of packaging: packed in cardboard

FRONT-MC 1,5/ 2-ST-3,81 - Printed-circuit board connector

1850660

<https://www.phoenixcontact.com/in/products/1850660>



PCB connector, nominal cross section: 1.5 mm², color: green, nominal current: 8 A, rated voltage (III/2): 160 V, contact surface: Tin, type of contact: Socket, number of potentials: 2, number of rows: 1, number of positions: 2, number of connections: 2, product range: FRONT-MC 1,5/..-ST, pitch: 3.81 mm, connection method: Front screw connection, screw head form: L Slotted, conductor/PCB connection direction: 0 °, plug-in system: COMBICON MC 1,5, locking: without, mounting: without, type of packaging: packed in cardboard

MCV 1,5/ 2-G-3,81 - PCB header

1803426

<https://www.phoenixcontact.com/in/products/1803426>



FK-MCP 1,5/ 2-ST-3,81 - PCB connector

1851041

<https://www.phoenixcontact.com/in/products/1851041>



PCB connector, nominal cross section: 1.5 mm², color: green, nominal current: 8 A, rated voltage (III/2): 160 V, contact surface: Tin, type of contact: Socket, number of potentials: 2, number of rows: 1, number of positions: 2, number of connections: 2, product range: FK-MCP 1,5/..-ST, pitch: 3.81 mm, connection method: Push-in spring connection, conductor/PCB connection direction: 0 °, plug-in system: COMBICON MC 1,5, locking: without, mounting: without, type of packaging: packed in cardboard

MCC 1/ 2-STZ-3,81 - PCB connector

1852176

<https://www.phoenixcontact.com/in/products/1852176>



PCB connector, nominal cross section: 1 mm², color: green, nominal current: 8 A, rated voltage (III/2): 160 V, type of contact: Socket, number of potentials: 2, number of rows: 1, number of positions: 2, number of connections: 2, product range: MCC 1/..-STZ, pitch: 3.81 mm, connection method: Crimp connection, conductor/PCB connection direction: 0 °, plug-in system: COMBICON MC 1,5, locking: without, mounting: without, type of packaging: packed in cardboard, Corresponding female crimp contacts with current [A] and conductor cross section range [mm²] data: 5A/MCC-MT 0,2-0,35 (1859988); 8A/MCC-MT 0,5-1,0 (1859991)

MCV 1,5/ 2-G-3,81 - PCB header

1803426

<https://www.phoenixcontact.com/in/products/1803426>



QC 0,5/ 2-ST-3,81 - Printed-circuit board connector

1897393

<https://www.phoenixcontact.com/in/products/1897393>

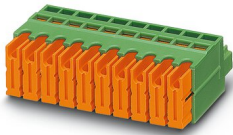

PCB connector, nominal cross section: 0.5 mm², color: green, nominal current: 6 A, rated voltage (III/2): 200 V, contact surface: Tin, type of contact: Socket, number of potentials: 2, number of rows: 1, number of positions: 2, number of connections: 2, product range: QC 0,5/...-ST, pitch: 3.81 mm, connection method: Displacement connection, conductor/PCB connection direction: 0 °, plug-in system: COMBICON MC 1,5, locking: without, mounting: without, type of packaging: packed in cardboard

Phoenix Contact 2023 © - all rights reserved

<https://www.phoenixcontact.com>

PHOENIX CONTACT (I) Pvt. Ltd.

A-58/2, Okhla Industrial Area, Phase - II, New Delhi-110 020

+91.1275.71420

info@phoenixcontact.co.in