

FRONT-MSTB 2,5/ 3-STF-5,08 - PCB connector



1777811

<https://www.phoenixcontact.com/in/products/1777811>

Please be informed that the data shown in this PDF document is generated from our online catalog. Please find the complete data in the user documentation. Our general terms of use for downloads are valid.



PCB connector, nominal cross section: 2.5 mm², color: green, nominal current: 12 A, rated voltage (III/2): 320 V, contact surface: Tin, contact connection type: Socket, number of potentials: 3, number of rows: 1, number of positions: 3, number of connections: 3, product range: FRONT-MSTB 2,5/...STF, pitch: 5.08 mm, connection method: Front screw connection, screw head form: L Slotted, conductor/PCB connection direction: 0 °, locking clip: - Locking clip, plug-in system: COMBICON MSTB 2,5, locking: Screw locking mechanism, mounting: Screw flange, type of packaging: packed in cardboard

Your advantages

- Well-known connection principle allows worldwide use
- Optimized for tight installation situations: operation and conductor connection from one direction
- Screwable flange for superior mechanical stability
- Low temperature rise, thanks to maximum contact force
- Allows connection of two conductors

Commercial data

Item number	1777811
Packing unit	100 pc
Minimum order quantity	100 pc
Sales key	AAC
Product key	AACABB
Catalog page	Page 269 (C-1-2013)
GTIN	4017918039684
Weight per piece (including packing)	9.996 g
Weight per piece (excluding packing)	9.715 g
Customs tariff number	85366990
Country of origin	DE

FRONT-MSTB 2,5/ 3-STF-5,08 - PCB connector



1777811

<https://www.phoenixcontact.com/in/products/1777811>

Technical data

Product properties

Product type	PCB connector
Product family	FRONT-MSTB 2,5/..-STF
Product line	COMBICON Connectors M
Type	Standard
Number of positions	3
Pitch	5.08 mm
Number of connections	3
Number of rows	1
Number of potentials	3
Mounting flange	Screw flange

Electrical properties

Nominal current I_N	12 A
Nominal voltage U_N	320 V
Degree of pollution	3
Contact resistance	1.5 m Ω
Rated voltage (III/3)	250 V
Rated surge voltage (III/3)	4 kV
Rated voltage (III/2)	320 V
Rated surge voltage (III/2)	4 kV
Rated voltage (II/2)	630 V
Rated surge voltage (II/2)	4 kV

Connection data

Connection technology

Type	Standard
Connector system	COMBICON MSTB 2,5
Nominal cross section	2.5 mm ²
Contact connection type	Socket

Interlock

Locking type	Screw locking mechanism
Mounting flange	Screw flange
Tightening torque	0.3 Nm

Conductor connection

Connection method	Front screw connection
Conductor/PCB connection direction	0 °
Conductor cross section rigid	0.34 mm ² ... 2.5 mm ²
Conductor cross section flexible	0.2 mm ² ... 2.5 mm ²
Conductor cross section AWG	24 ... 12

FRONT-MSTB 2,5/ 3-STF-5,08 - PCB connector



1777811

<https://www.phoenixcontact.com/in/products/1777811>

Conductor cross section flexible, with ferrule without plastic sleeve	0.25 mm ² ... 2.5 mm ²
Conductor cross section, flexible, with ferrule, with plastic sleeve	0.25 mm ² ... 2.5 mm ²
2 conductors with same cross section, solid	0.2 mm ² ... 1.5 mm ²
2 conductors with same cross section, flexible	0.2 mm ² ... 1.5 mm ²
2 conductors with same cross section, flexible, with ferrule without plastic sleeve	0.25 mm ² ... 1 mm ²
2 conductors with the same cross section, flexible, with TWIN ferrule with plastic sleeve	0.5 mm ² ... 1 mm ²
Cylindrical gauge a x b / diameter	2.8 mm x 2.0 mm / 2.4 mm
Stripping length	10 mm
Tightening torque	0.5 Nm ... 0.6 Nm

Specifications for ferrules without insulating collar

recommended crimping tool	1212034 CRIMPFOX 6
ferrules without insulating collar, according to DIN 46228-1	Cross section: 0.5 mm ² ; Length: 8 mm ... 10 mm
	Cross section: 0.75 mm ² ; Length: 8 mm ... 10 mm
	Cross section: 1 mm ² ; Length: 8 mm ... 10 mm
	Cross section: 1.5 mm ² ; Length: 8 mm ... 10 mm
	Cross section: 2.5 mm ² ; Length: 10 mm

Specifications for ferrules with insulating collar

recommended crimping tool	1212034 CRIMPFOX 6
ferrules with insulating collar, according to DIN 46228-4	Cross section: 0.5 mm ² ; Length: 8 mm ... 10 mm
	Cross section: 0.75 mm ² ; Length: 8 mm ... 10 mm
	Cross section: 1 mm ² ; Length: 8 mm ... 10 mm
	Cross section: 1.5 mm ² ; Length: 8 mm ... 10 mm
	Cross section: 2.5 mm ² ; Length: 10 mm

Material specifications

Material data - contact

Note	WEEE/RoHS-compliant, free of whiskers according to IEC 60068-2-82/JEDEC JESD 201
Contact material	Cu alloy
Surface characteristics	hot-dip tin-plated
Metal surface terminal point (top layer)	Tin (4 - 8 µm Sn)
Metal surface contact area (top layer)	Tin (4 - 8 µm Sn)

Material data - housing

Color (Housing)	green (6021)
Insulating material	PA
Insulating material group	I
CTI according to IEC 60112	600
Flammability rating according to UL 94	V0
Glow wire flammability index GWFI according to EN 60695-2-12	850

FRONT-MSTB 2,5/ 3-STF-5,08 - PCB connector



1777811

<https://www.phoenixcontact.com/in/products/1777811>

Glow wire ignition temperature GWIT according to EN 60695-2-13	775
Temperature for the ball pressure test according to EN 60695-10-2	125 °C

Dimensions

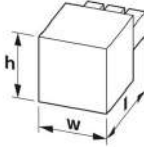
Dimensional drawing	
Pitch	5.08 mm
Width [w]	25.04 mm
Height [h]	15 mm
Length [l]	27.2 mm

Mounting

Drive form screw head	Slotted (L)
Flange	
Tightening torque	0.3 Nm

Notes

Notes on operation	In accordance with IEC 61984, COMBICON connectors have no switching power (COC). During designated use, they must not be plugged in or disconnected when carrying voltage or under load.
--------------------	--

Mechanical tests

Test for conductor damage and slackening

Specification	IEC 60999-1:1999-11
Result	Test passed

Pull-out test

Specification	IEC 60999-1:1999-11
Conductor cross section/conductor type/tractive force setpoint/actual value	0.34 mm ² / solid / > 15 N
	0.2 mm ² / flexible / > 10 N
	2.5 mm ² / solid / > 50 N
	2.5 mm ² / flexible / > 50 N

Insertion and withdrawal forces

Result	Test passed
No. of cycles	25
Insertion strength per pos. approx.	12 N
Withdraw strength per pos. approx.	9 N

Torque test

FRONT-MSTB 2,5/ 3-STF-5,08 - PCB connector



1777811

<https://www.phoenixcontact.com/in/products/1777811>

Specification	IEC 60999-1:1999-11
Resistance of inscriptions	
Specification	IEC 60068-2-70:1995-12
Result	Test passed
Polarization and coding	
Specification	IEC 60512-13-5:2006-02
Result	Test passed
Visual inspection	
Specification	IEC 60512-1-1:2002-02
Result	Test passed
Dimension check	
Specification	IEC 60512-1-2:2002-02
Result	Test passed

Environmental and real-life conditions

Vibration test

Specification	IEC 60068-2-6:2007-12
Frequency	10 - 150 - 10 Hz
Sweep speed	1 octave/min
Amplitude	0.35 mm (10 Hz ... 60.1 Hz)
Acceleration	5g (60.1 Hz ... 150 Hz)
Test duration per axis	2.5 h

Durability test

Specification	IEC 60512-9-1:2010-03
Impulse withstand voltage at sea level	4.8 kV
Contact resistance R ₁	1.5 mΩ
Contact resistance R ₂	1.6 mΩ
Contact resistance R ₂ 2nd level	1.9 mΩ
Insertion/withdrawal cycles	25
Insulation resistance, neighboring positions	> 5 MΩ

Climatic test

Specification	ISO 6988:1985-02
Corrosive stress	0.2 dm ³ SO ₂ on 300 dm ³ /40 °C/1 cycle
Thermal stress	100 °C/168 h
Power-frequency withstand voltage	2.21 kV

Ambient conditions

Ambient temperature (operation)	-40 °C ... 100 °C (dependent on the derating curve)
Ambient temperature (storage/transport)	-40 °C ... 70 °C
Relative humidity (storage/transport)	30 % ... 70 %
Ambient temperature (assembly)	-5 °C ... 100 °C

FRONT-MSTB 2,5/ 3-STF-5,08 - PCB connector



1777811

<https://www.phoenixcontact.com/in/products/1777811>

Electrical tests

Thermal test | Test group C

Specification	IEC 60512-5-1:2002-02
Tested number of positions	17

Insulation resistance

Specification	IEC 60512-3-1:2002-02
Insulation resistance, neighboring positions	> 5 MΩ

Air clearances and creepage distances |

Specification	IEC 60664-1:2007-04
Insulating material group	I
Comparative tracking index (IEC 60112)	CTI 600
Rated insulation voltage (III/3)	250 V
Rated surge voltage (III/3)	4 kV
minimum clearance value - non-homogenous field (III/3)	3 mm
minimum creepage distance (III/3)	3.2 mm
Rated insulation voltage (III/2)	320 V
Rated surge voltage (III/2)	4 kV
minimum clearance value - non-homogenous field (III/2)	3 mm
minimum creepage distance (III/2)	3 mm
Rated insulation voltage (II/2)	630 V
Rated surge voltage (II/2)	4 kV
minimum clearance value - non-homogenous field (II/2)	3 mm
minimum creepage distance (II/2)	3.2 mm

Packaging specifications

Type of packaging	packed in cardboard
-------------------	---------------------

1777811

<https://www.phoenixcontact.com/in/products/1777811>

Drawings

Diagram

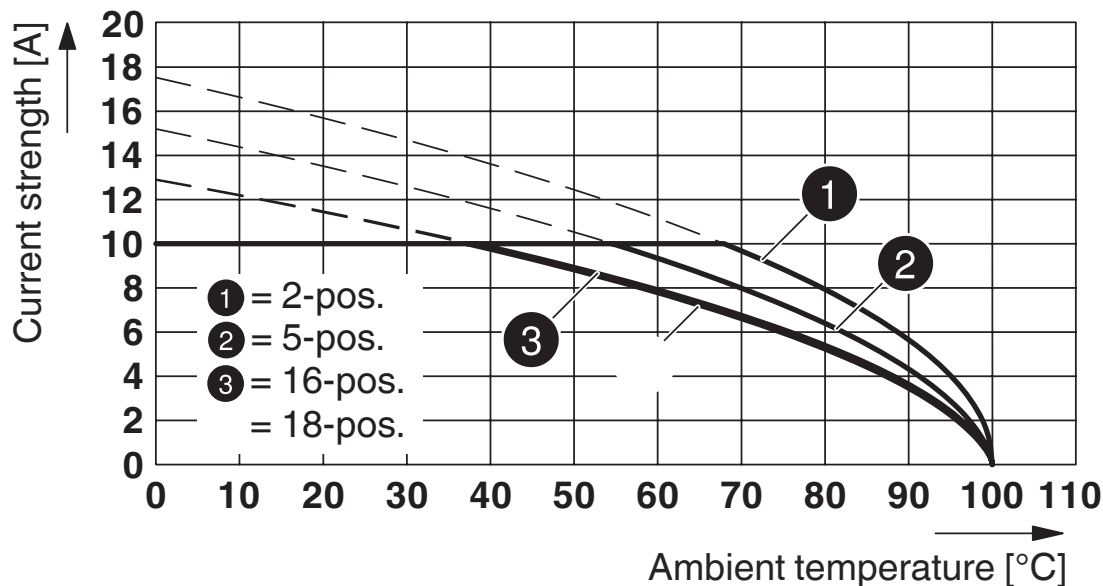

Type: FRONT-MSTB 2,5/...-STF-5,08 with MDSTBV 2,5/...-GF-5,08

Diagram

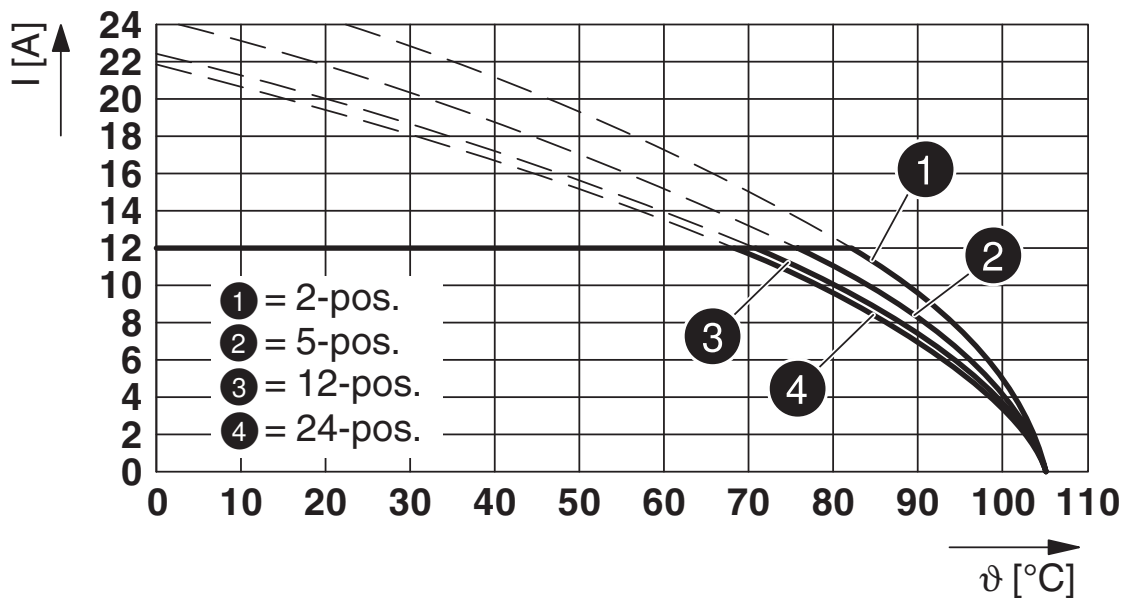

Type: FRONT-MSTB 2,5/...-STF-5,08 with CCV 2,5/...-GF-5,08-LR P...THR

1777811

<https://www.phoenixcontact.com/in/products/1777811>

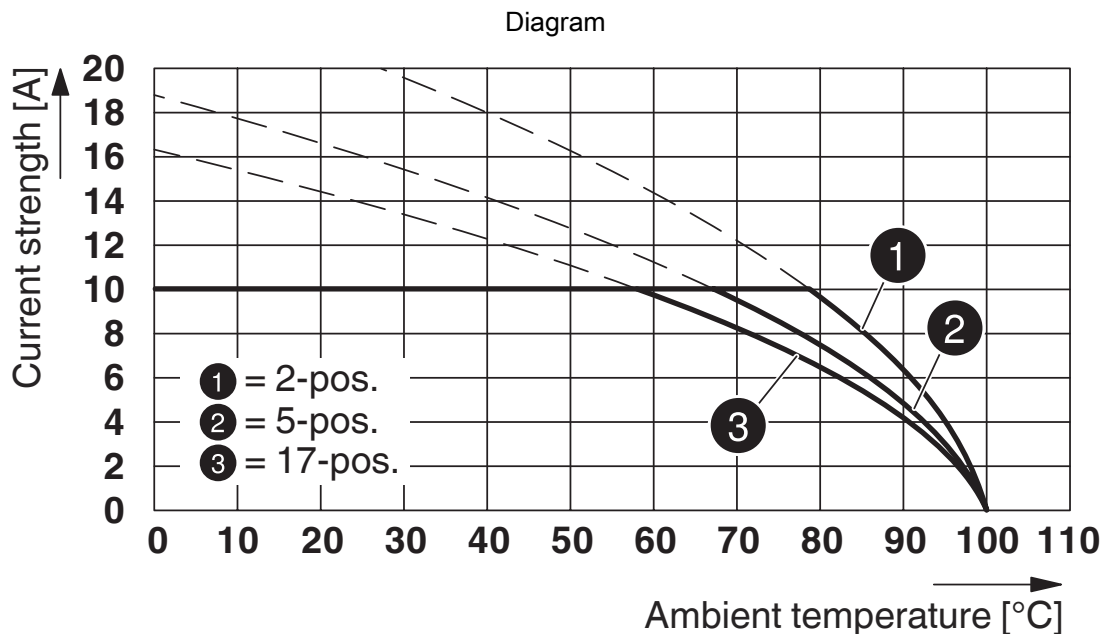

Type: FRONT-MSTB 2,5/...-STF-5,08 with MDSTB 2,5/...-GF-5,08

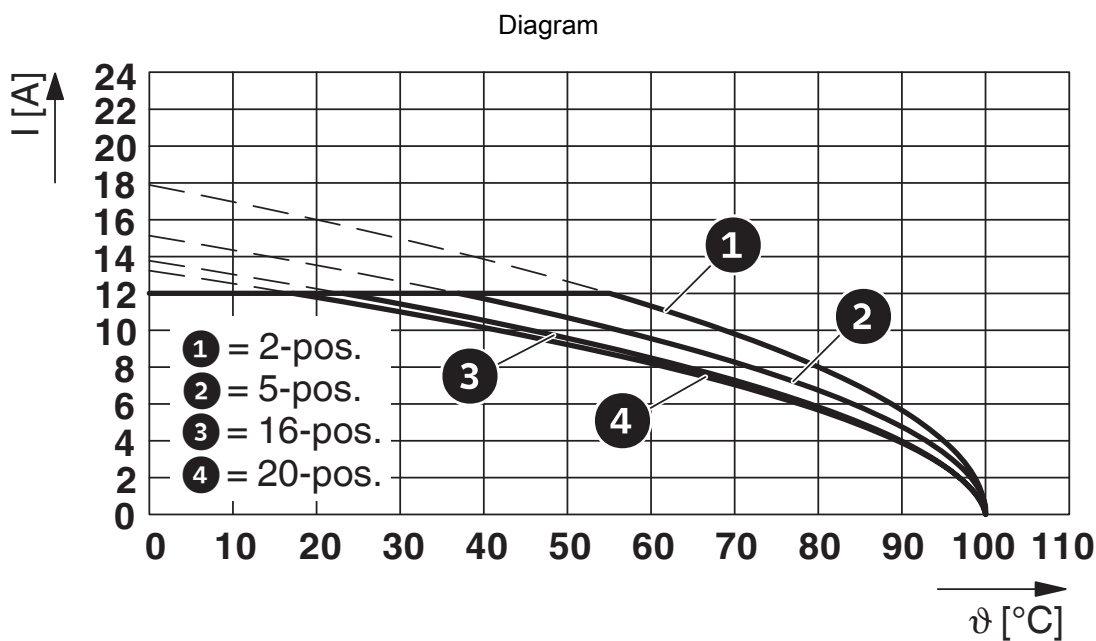

Type: FRONT-MSTB 2,5/...-STF-5,08 with MSTBV 2,5/...-GF-5,08

1777811

<https://www.phoenixcontact.com/in/products/1777811>

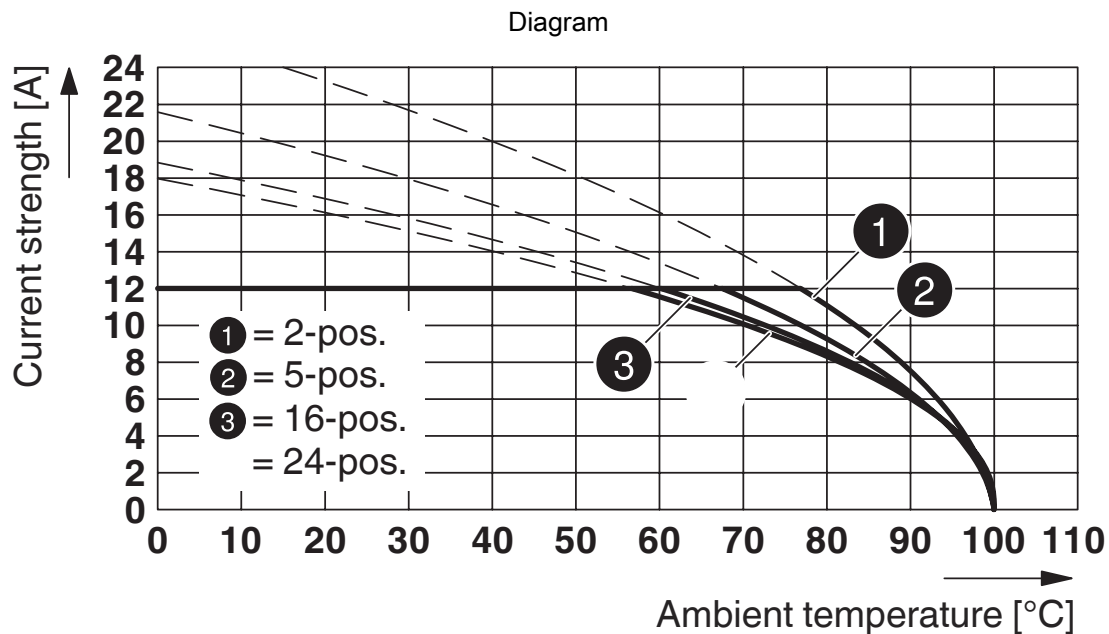

Type: FRONT-MSTB 2,5/...-STF-5,08 with MSTB 2,5/...-GF-5,08

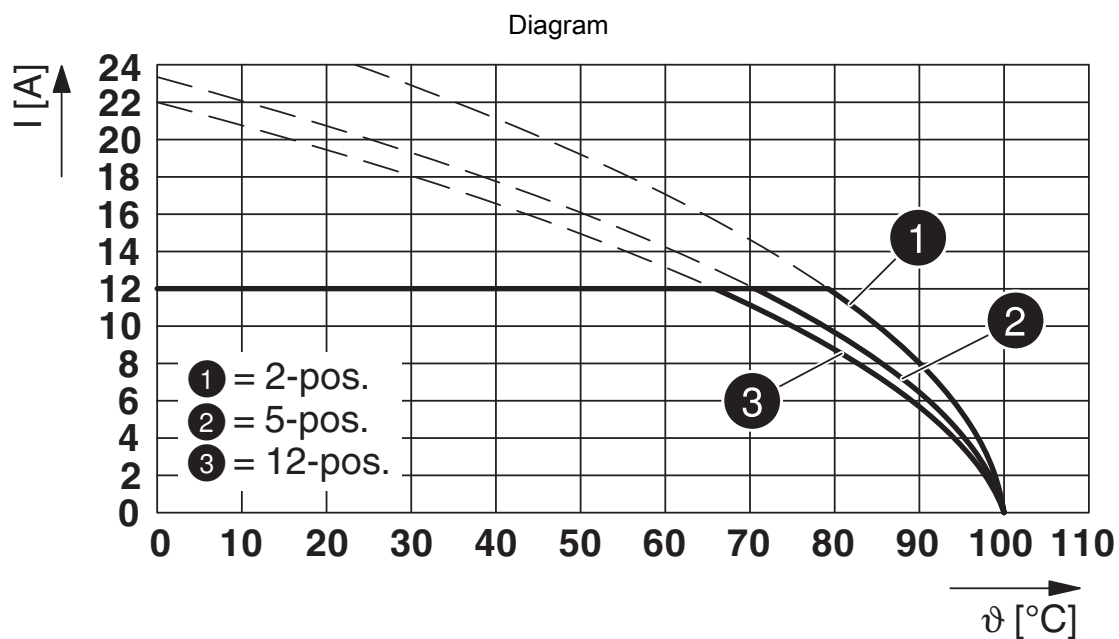

Type: FRONT-MSTB 2,5/...-STF-5,08 with CC 2,5/...-GF-5,08-LR P...THR

FRONT-MSTB 2,5/ 3-STF-5,08 - PCB connector



1777811

<https://www.phoenixcontact.com/in/products/1777811>

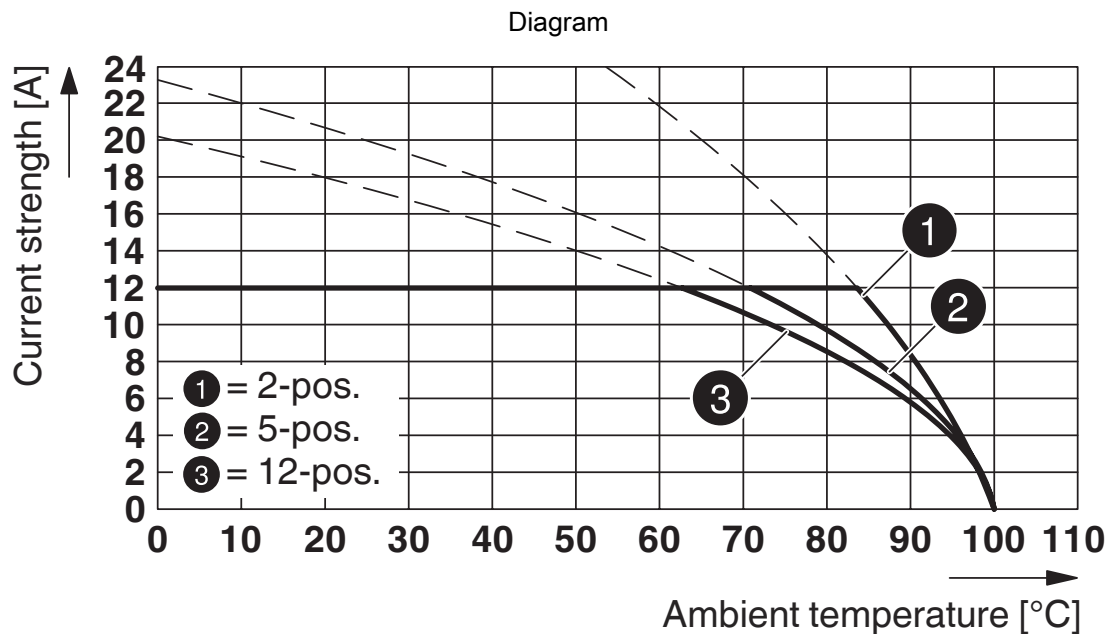

Type: FRONT-MSTB 2,5/...-STF-5,08 with CCV 2,5/...-GF-5,08 P26THR

Dimensional drawing

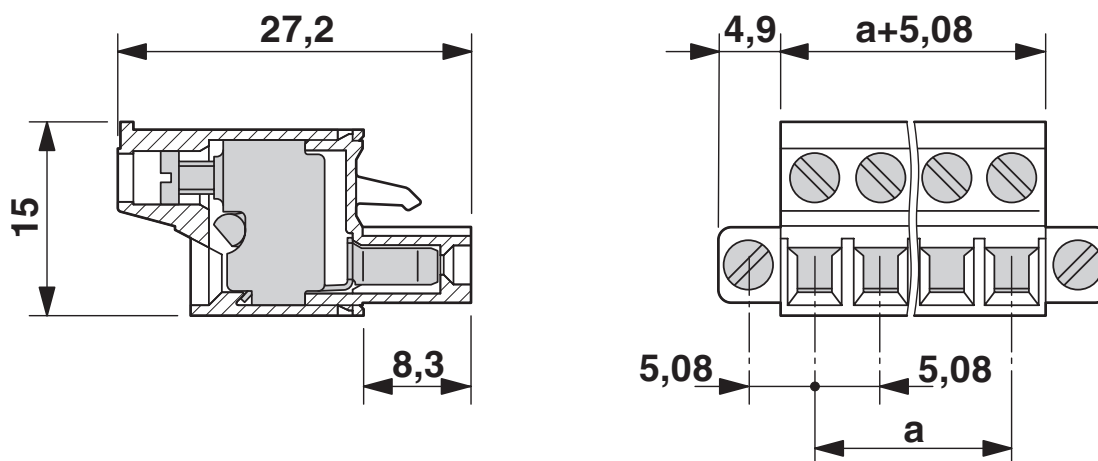

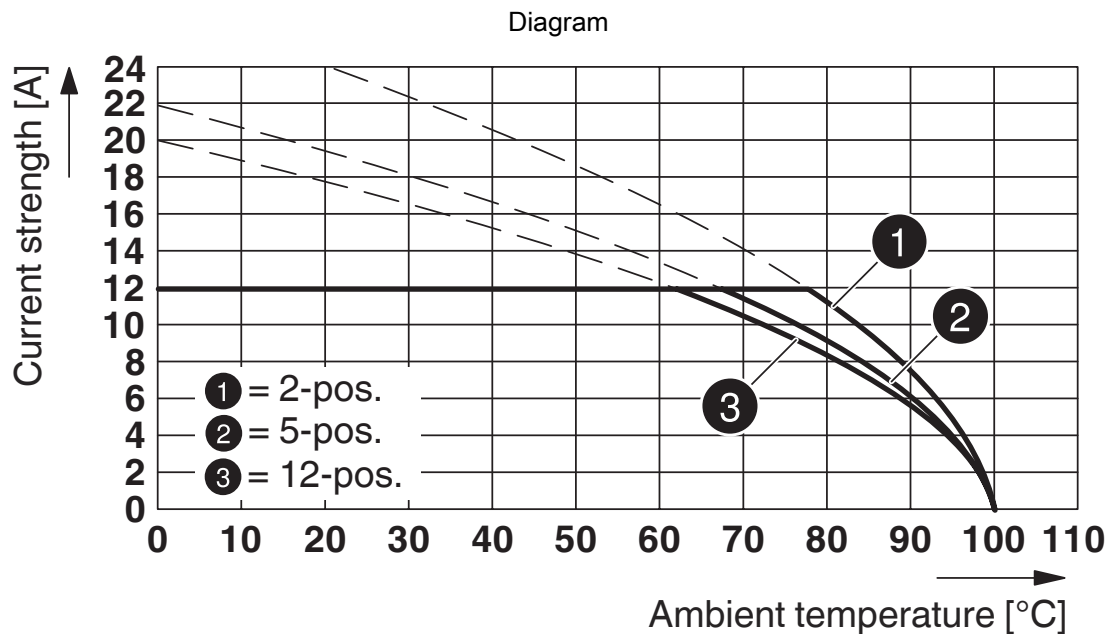

Type: FRONT-MSTB 2,5/...-STF-5,08 with CC 2,5/...-GF-5,08 P26THR

FRONT-MSTB 2,5/ 3-STF-5,08 - PCB connector





1777811

<https://www.phoenixcontact.com/in/products/1777811>

Approvals

To download certificates, visit the product detail page: <https://www.phoenixcontact.com/in/products/1777811>

 CSA Approval ID: 13631				
	Nominal voltage U_N	Nominal current I_N	Cross section AWG	Cross section mm^2
Use group B				
	300 V	15 A	22 - 12	-
Use group D				
	300 V	10 A	22 - 12	-

 cULus Recognized Approval ID: E60425-19931011				
	Nominal voltage U_N	Nominal current I_N	Cross section AWG	Cross section mm^2
Use group B				
	300 V	15 A	30 - 12	-
Use group D				
	300 V	10 A	30 - 12	-

 DNV GL Approval ID: TAE00001EY				
--	--	--	--	--

 VDE Zeichengenehmigung Approval ID: 40050694				
	Nominal voltage U_N	Nominal current I_N	Cross section AWG	Cross section mm^2
	250 V	12 A	-	0.34 - 2.5

FRONT-MSTB 2,5/ 3-STF-5,08 - PCB connector



1777811

<https://www.phoenixcontact.com/in/products/1777811>

Classifications

ECLASS

ECLASS-11.0	27460202
ECLASS-12.0	27460202
ECLASS-13.0	27460202

ETIM

ETIM 9.0	EC002638
----------	----------

UNSPSC

UNSPSC 21.0	39121400
-------------	----------

FRONT-MSTB 2,5/ 3-STF-5,08 - PCB connector



1777811

<https://www.phoenixcontact.com/in/products/1777811>

Environmental product compliance

EU RoHS

Fulfills EU RoHS substance requirements	Yes, No exemptions
---	--------------------

China RoHS

Environment friendly use period (EFUP)	EFUP-E
	No hazardous substances above the limits

EU REACH SVHC

REACH candidate substance (CAS No.)	No substance above 0.1 wt%
-------------------------------------	----------------------------

FRONT-MSTB 2,5/ 3-STF-5,08 - PCB connector

1777811

<https://www.phoenixcontact.com/in/products/1777811>

Accessories

 Note: Applying some accessories below might limit this product.

EBL 2- 5 - Insertion bridge

2303145

<https://www.phoenixcontact.com/in/products/2303145>

Insertion bridge, pitch: 5.2 mm, number of positions: 2, color: gray



 Max. current carrying capacity: 24 A

EBL 3- 5 - Insertion bridge

2303158

<https://www.phoenixcontact.com/in/products/2303158>

Insertion bridge, pitch: 5.2 mm, number of positions: 3, color: gray



 Max. current carrying capacity: 24 A

FRONT-MSTB 2,5/ 3-STF-5,08 - PCB connector



1777811

<https://www.phoenixcontact.com/in/products/1777811>

FRONT-MSTB-EW - Accessories

1763058

<https://www.phoenixcontact.com/in/products/1763058>



Removal aid, for FRONT-MSTB, facilitates extraction of several plugs mounted behind each other

SZS 0,6X3,5 - Screwdriver

1205053

<https://www.phoenixcontact.com/in/products/1205053>



Actuation tool, for ST terminal blocks, insulated, also suitable for use as a bladed screwdriver, size: 0.6 x 3.5 x 100 mm, 2-component grip, with non-slip grip

FRONT-MSTB 2,5/ 3-STF-5,08 - PCB connector



1777811

<https://www.phoenixcontact.com/in/products/1777811>

CP-MSTB - Coding profile

1734634

<https://www.phoenixcontact.com/in/products/1734634>

Coding profile, is inserted into the slot on the plug or inverted header, red insulating material



SK 5,08/3,8:FORTL.ZAHLEN - Marker card

0804293

<https://www.phoenixcontact.com/in/products/0804293>

Marker card, white, labeled, horizontal: consecutive numbers 1 ... 10, 11 ... 20, etc. up to 91 ... (99)100, mounting type: adhesive, for terminal block width: 5.08 mm, lettering field size: 5.08 x 3.8 mm



FRONT-MSTB 2,5/ 3-STF-5,08 - PCB connector



1777811

<https://www.phoenixcontact.com/in/products/1777811>

SK U/2,8 WH:UNBEDRUCKT - Marker card

0803883

<https://www.phoenixcontact.com/in/products/0803883>

Marker card, Din A4, white, unlabeled, can be labeled with: PLOTMARK, CMS-P1-PLOTTER, Office printing systems, mounting type: adhesive, for terminal block width: 210 mm, lettering field size: 186 x 2.8 mm, Number of individual labels: 3600



MSTB 2,5/ 3-GF-5,08 - PCB header

1776511

<https://www.phoenixcontact.com/in/products/1776511>

PCB headers, nominal cross section: 2.5 mm², color: green, nominal current: 12 A, rated voltage (III/2): 320 V, contact surface: Tin, contact connection type: Pin, number of potentials: 3, number of rows: 1, number of positions: 3, number of connections: 3, product range: MSTB 2,5/..-GF, pitch: 5.08 mm, mounting: Wave soldering, pin layout: Linear pinning, solder pin [P]: 3.23 mm, number of solder pins per potential: 1, plug-in system: COMBICON MSTB 2,5, Pin connector pattern alignment: Standard, locking: Screw locking mechanism, mounting: Threaded flange, type of packaging: packed in cardboard



FRONT-MSTB 2,5/ 3-STF-5,08 - PCB connector



1777811

<https://www.phoenixcontact.com/in/products/1777811>

MSTBV 2,5/ 3-GF-5,08 - PCB header

1777086

<https://www.phoenixcontact.com/in/products/1777086>

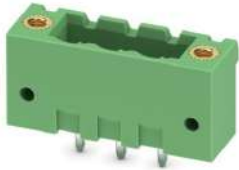

PCB headers, nominal cross section: 2.5 mm², color: green, nominal current: 12 A, rated voltage (III/2): 320 V, contact surface: Tin, contact connection type: Pin, number of potentials: 3, number of rows: 1, number of positions: 3, number of connections: 3, product range: MSTBV 2,5/..-GF, pitch: 5.08 mm, mounting: Wave soldering, pin layout: Linear pinning, solder pin [P]: 3.9 mm, number of solder pins per potential: 1, plug-in system: COMBICON MSTB 2,5, Pin connector pattern alignment: Standard, locking: Screw locking mechanism, mounting: Threaded flange, type of packaging: packed in cardboard

DFK-MSTBVA 2,5/ 3-GF-5,08 - Feed-through header

1899294

<https://www.phoenixcontact.com/in/products/1899294>



Feed-through header, nominal cross section: 2.5 mm², color: green, nominal current: 12 A, rated voltage (III/2): 320 V, contact surface: Tin, contact connection type: Pin, number of potentials: 3, number of rows: 1, number of positions: 3, number of connections: 3, product range: DFK-MSTBVA 2,5/..-GF, pitch: 5.08 mm, mounting: Wave soldering, pin layout: Linear pinning, solder pin [P]: 3.9 mm, number of solder pins per potential: 1, plug-in system: COMBICON MSTB 2,5, Pin connector pattern alignment: Standard, locking: Screw locking mechanism, mounting: Threaded flange, type of packaging: packed in cardboard

FRONT-MSTB 2,5/ 3-STF-5,08 - PCB connector



1777811

<https://www.phoenixcontact.com/in/products/1777811>

CC 2,5/ 3-GF-5,08 P26THRR56 - PCB header

1954812

<https://www.phoenixcontact.com/in/products/1954812>



PCB headers, nominal cross section: 2.5 mm², color: black, nominal current: 12 A, rated voltage (III/2): 320 V, contact surface: Tin, contact connection type: Pin, number of potentials: 3, number of rows: 1, number of positions: 3, number of connections: 3, product range: CC 2,5/..-GF, pitch: 5.08 mm, mounting: THR soldering, pin layout: Linear pinning, solder pin [P]: 2.6 mm, number of solder pins per potential: 1, plug-in system: COMBICON MSTB 2,5, Pin connector pattern alignment: Standard, locking: Screw locking mechanism, mounting: Threaded flange, type of packaging: 56 mm wide tape, For user information and design recommendations for through-hole reflow technology, go to: Downloads

CCV 2,5/ 3-GF-5,08 P26THR - PCB header

1955646

<https://www.phoenixcontact.com/in/products/1955646>



PCB headers, nominal cross section: 2.5 mm², color: black, nominal current: 12 A, rated voltage (III/2): 320 V, contact surface: Tin, contact connection type: Pin, number of potentials: 3, number of rows: 1, number of positions: 3, number of connections: 3, product range: CCV 2,5/..-GF, pitch: 5.08 mm, mounting: THR soldering, pin layout: Linear pinning, solder pin [P]: 2.6 mm, number of solder pins per potential: 1, plug-in system: COMBICON MSTB 2,5, Pin connector pattern alignment: Standard, locking: Screw locking mechanism, mounting: Threaded flange, type of packaging: packed in cardboard, For user information and design recommendations for through-hole reflow technology, go to: Downloads

FRONT-MSTB 2,5/ 3-STF-5,08 - PCB connector



1777811

<https://www.phoenixcontact.com/in/products/1777811>

CCV 2,5/ 3-GF-5,08 P26THRR56 - PCB header

1955756

<https://www.phoenixcontact.com/in/products/1955756>



PCB headers, nominal cross section: 2.5 mm², color: black, nominal current: 12 A, rated voltage (III/2): 320 V, contact surface: Tin, contact connection type: Pin, number of potentials: 3, number of rows: 1, number of positions: 3, number of connections: 3, product range: CCV 2,5/..-GF, pitch: 5.08 mm, mounting: THR soldering, pin layout: Linear pinning, solder pin [P]: 2.6 mm, number of solder pins per potential: 1, plug-in system: COMBICON MSTB 2,5, Pin connector pattern alignment: Standard, locking: Screw locking mechanism, mounting: Threaded flange, type of packaging: 56 mm wide tape, For user information and design recommendations for through-hole reflow technology, go to: Downloads

Phoenix Contact 2024 © - all rights reserved

<https://www.phoenixcontact.com>

PHOENIX CONTACT (I) Pvt. Ltd.

A-58/2, Okhla Industrial Area, Phase - II, New Delhi-110 020

+91.1275.71420

info@phoenixcontact.co.in