

MKDS 5/ 3-9,5 - PCB terminal block



1714984

<https://www.phoenixcontact.com/in/products/1714984>

Please be informed that the data shown in this PDF document is generated from our Online Catalog. Please find the complete data in the user documentation. Our General Terms of Use for Downloads are valid.



PCB terminal block, nominal current: 32 A, rated voltage (III/2): 1000 V, nominal cross section: 4 mm², number of potentials: 3, number of rows: 1, number of positions per row: 3, product range: MKDS 5, pitch: 9.52 mm, connection method: Screw connection with tension sleeve, mounting: Wave soldering, conductor/PCB connection direction: 0 °, color: green, Pin layout: Linear pinning, Solder pin [P]: 5 mm, number of solder pins per potential: 1, type of packaging: packed in cardboard. The article can be aligned to create different nos. of positions!

Your advantages

- Well-known connection principle allows worldwide use
- Low temperature rise, thanks to maximum contact force
- Allows connection of two conductors

Commercial Data

Item number	1714984
Packing unit	50 pc
Minimum order quantity	50 pc
Sales Key	AAN
Product Key	AANFDA
Catalog Page	Page 443 (C-1-2013)
GTIN	4017918024123
Weight per Piece (including packing)	9.53 g
Weight per Piece (excluding packing)	8.762 g
Customs tariff number	85369010
Country of origin	DE

MKDS 5/ 3-9,5 - PCB terminal block



1714984

<https://www.phoenixcontact.com/in/products/1714984>

Technical Data

Product properties

Type	PC terminal block can be aligned
Product line	COMBICON Terminals L
Product type	Printed circuit board terminal
Product family	MKDS 5
Number of positions	3
Pitch	9.52 mm
Number of connections	3
Number of rows	1
Number of potentials	3
Pin layout	Linear pinning
Solder pins per potential	1

Electrical properties

Nominal current I_N	32 A
Nominal voltage U_N	1000 V
Degree of pollution	3
Rated voltage (III/3)	690 V
Rated surge voltage (III/3)	8 kV
Rated voltage (III/2)	1000 V
Rated surge voltage (III/2)	8 kV
Rated voltage (II/2)	1000 V
Rated surge voltage (II/2)	6 kV

Connection data

Connection technology

Type	PC terminal block can be aligned
Nominal cross section	4 mm ²

Conductor connection

Connection method	Screw connection with tension sleeve
Conductor cross section rigid	0.2 mm ² ... 6 mm ²
Conductor cross section flexible	0.2 mm ² ... 4 mm ²
Conductor cross section AWG	24 ... 10
Conductor cross section flexible, with ferrule without plastic sleeve	0.25 mm ² ... 4 mm ²
Conductor cross section, flexible, with ferrule, with plastic sleeve	0.25 mm ² ... 4 mm ²
2 conductors with same cross section, solid	0.2 mm ² ... 1.5 mm ²
2 conductors with same cross section, flexible	0.2 mm ² ... 1.5 mm ²
2 conductors with same cross section, flexible, with ferrule without plastic sleeve	0.25 mm ² ... 0.75 mm ²
2 conductors with the same cross section, flexible, with TWIN	0.5 mm ² ... 2.5 mm ²

MKDS 5/ 3-9,5 - PCB terminal block



1714984

<https://www.phoenixcontact.com/in/products/1714984>

ferrule with plastic sleeve	
Stripping length	8 mm
Tightening torque	0.5 Nm ... 0.6 Nm

Mounting

Mounting type	Wave soldering
Pin layout	Linear pinning
Drive form screw head	Slotted
Connection method	Screw connection with tension sleeve
Drive form screw head	Slotted

Material specifications

Material data - contact

Note	WEEE/RoHS-compliant, free of whiskers according to IEC 60068-2-82/JEDEC JESD 201
Contact material	Cu alloy
Surface characteristics	Tin-plated
Metal surface terminal point (top layer)	Tin (4 - 8 µm Sn)
Metal surface soldering area (top layer)	Tin (4 - 8 µm Sn)

Material data - housing

Color (Housing)	green (6021)
Insulating material	PA
Insulating material group	I
CTI according to IEC 60112	600
Flammability rating according to UL 94	V0
Glow wire flammability index GWFI according to EN 60695-2-12	850
Glow wire ignition temperature GWIT according to EN 60695-2-13	775
Temperature for the ball pressure test according to EN 60695-10-2	125 °C

Material data – actuating element

Color ()	()
----------	----

Notes

Note on application	For safe conductor connection, always adhere to a defined tightening torque. Particularly in the case of PCB terminal blocks with two or three positions, the individual solder pin for each contact point cannot compensate for this. That is why the terminal blocks must be supported during conductor connection (held with one hand, support on the housing).
---------------------	--

Dimensions

MKDS 5/ 3-9,5 - PCB terminal block

1714984

<https://www.phoenixcontact.com/in/products/1714984>

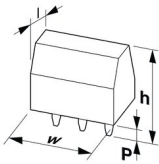
Dimensional drawing	
Pitch	9.52 mm
Width [w]	28.56 mm
Height [h]	26.5 mm
Length [l]	12.5 mm
Installed height	21.5 mm
Solder pin length [P]	5 mm

Mechanical tests

Test for conductor damage and slackening

Specification	IEC 60999-1:1999-11
Result	Test passed

Pull-out test

Specification	IEC 60999-1:1999-11
Conductor cross section/conductor type/tractive force setpoint/actual value	0.2 mm ² / solid / > 10 N
	0.2 mm ² / flexible / > 10 N
	6 mm ² / solid / > 80 N
	4 mm ² / flexible / > 60 N

Electrical tests

Temperature-rise test

Specification	IEC 60947-7-4:2019-01
Requirement temperature-rise test	The sum of ambient temperature and temperature rise of the PCB terminal block shall not exceed the upper limiting temperature.

Short-time withstand current

Specification	IEC 60947-7-4:2019-01
---------------	-----------------------

Insulation resistance

Specification	IEC 60512-3-1:2002-02
Insulation resistance, neighboring positions	> 5 MΩ

Air clearances and creepage distances |

Specification	IEC 60664-1:2007-04
Insulating material group	I
Comparative tracking index (IEC 60112)	CTI 600
Rated insulation voltage (III/3)	690 V
Rated surge voltage (III/3)	8 kV
minimum clearance value - non-homogenous field (III/3)	8 mm

MKDS 5/ 3-9,5 - PCB terminal block



1714984

<https://www.phoenixcontact.com/in/products/1714984>

minimum creepage distance (III/3)	8 mm
Rated insulation voltage (III/2)	1000 V
Rated surge voltage (III/2)	8 kV
minimum clearance value - non-homogenous field (III/2)	8 mm
minimum creepage distance (III/2)	8 mm
Rated insulation voltage (II/2)	1000 V
Rated surge voltage (II/2)	6 kV
minimum clearance value - non-homogenous field (II/2)	5.5 mm
minimum creepage distance (II/2)	5.5 mm

Environmental and real-life conditions

Vibration test

Specification	IEC 60068-2-6:2007-12
Frequency	10 - 150 - 10 Hz
Sweep speed	1 octave/min
Amplitude	0.35 mm (10 Hz ... 60.1 Hz)
Sweep speed	5g (60.1 Hz ... 150 Hz)
Test duration per axis	2.5 h

Glow-wire test

Specification	IEC 60695-2-10:2013-04
Temperature	850 °C
Time of exposure	5 s

Aging

Specification	IEC 60947-7-4:2019-01
---------------	-----------------------

Ambient conditions

Ambient temperature (operation)	-40 °C ... 105 °C (Depending on the current carrying capacity/derating curve)
Ambient temperature (storage/transport)	-40 °C ... 70 °C
Relative humidity (storage/transport)	30 % ... 70 %
Ambient temperature (assembly)	-5 °C ... 100 °C

Packaging specifications

Type of packaging	packed in cardboard
-------------------	---------------------

Drawings

Diagram

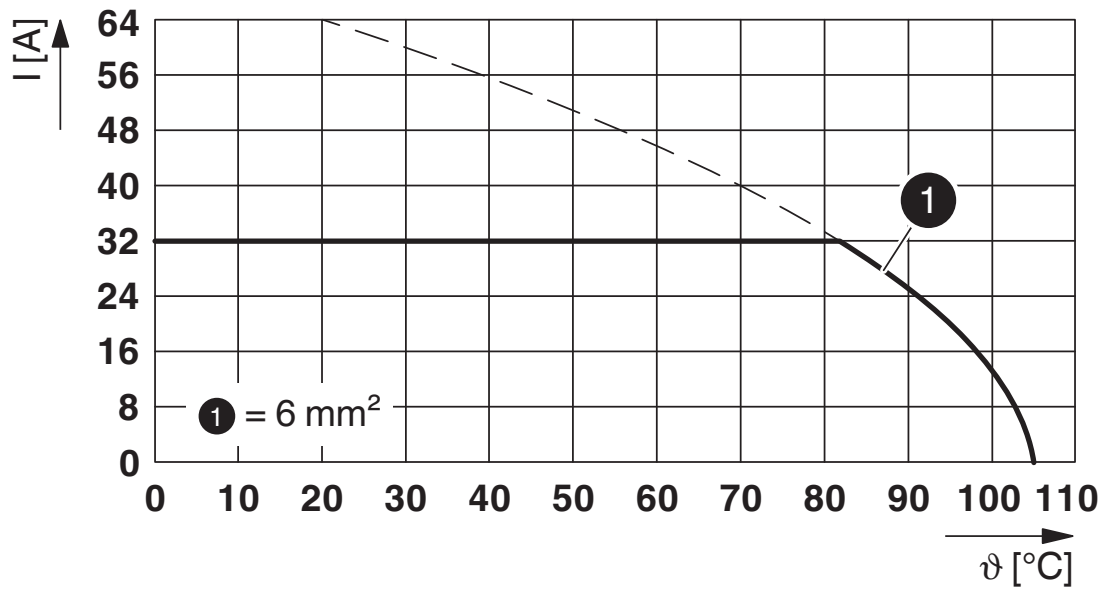

Type: MKDS 5/...-9,5

Drilling plan/solder pad geometry

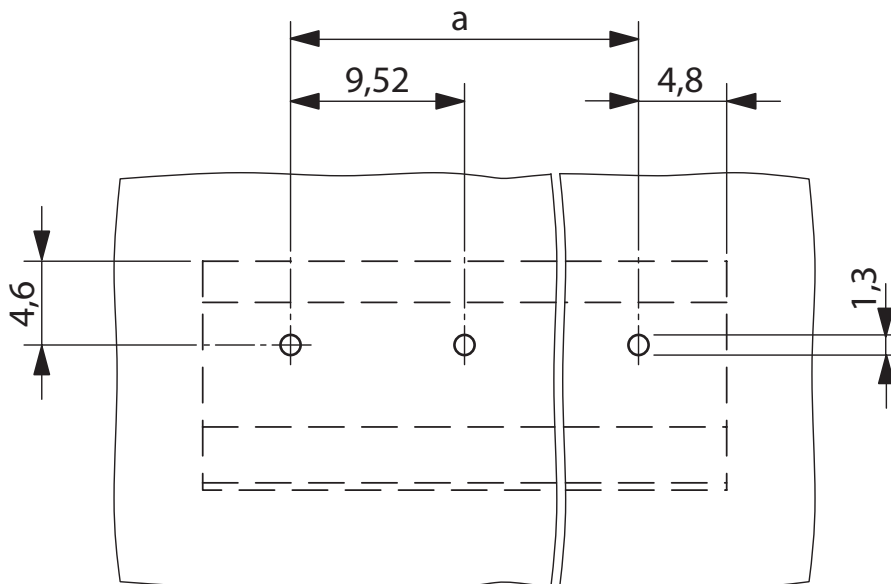

MKDS 5/ 3-9,5 - PCB terminal block

1714984

<https://www.phoenixcontact.com/in/products/1714984>

Dimensional drawing

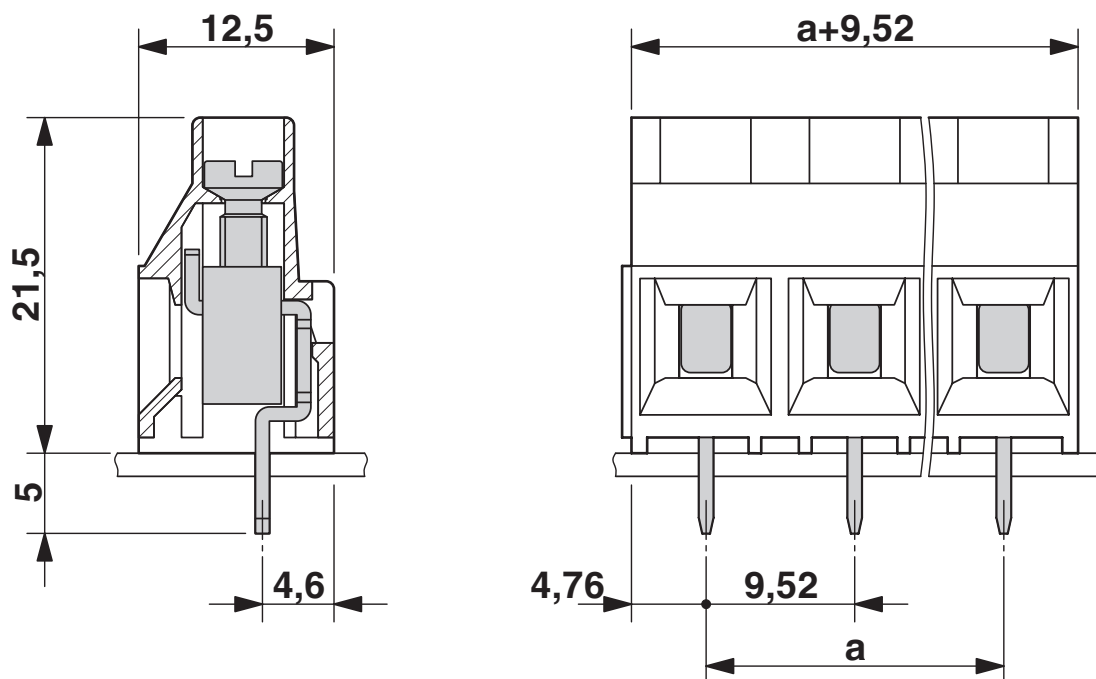

MKDS 5/ 3-9,5 - PCB terminal block





1714984

<https://www.phoenixcontact.com/in/products/1714984>

Approvals

 CSA Approval ID: 13631				
	Nominal Voltage U_N	Nominal Current I_N	Cross Section AWG	Cross Section mm^2
Use group B	300 V	30 A	28 - 10	-
Use group C	300 V	30 A	28 - 10	-

 EAC Approval ID: B.01687				
--	--	--	--	--

 cULus Recognized Approval ID: E60425-19770427				
	Nominal Voltage U_N	Nominal Current I_N	Cross Section AWG	Cross Section mm^2
Use group B	300 V	30 A	30 - 10	-
Use group C	300 V	30 A	30 - 10	-
Use group D	600 V	5 A	30 - 10	-

 DNV GL Approval ID: TAE00001EV				
--	--	--	--	--

 IECEE CB Scheme Approval ID: DE1-66542				
	Nominal Voltage U_N	Nominal Current I_N	Cross Section AWG	Cross Section mm^2
	1000 V	32 A	-	0.2 - 4

 VDE Zeichengenehmigung Approval ID: 40055394				
	Nominal Voltage U_N	Nominal Current I_N	Cross Section AWG	Cross Section mm^2
	1000 V	32 A	-	0.2 - 4

MKDS 5/ 3-9,5 - PCB terminal block



1714984

<https://www.phoenixcontact.com/in/products/1714984>

Classifications

ECLASS

ECLASS-11.0	27460101
ECLASS-12.0	27460101
ECLASS-13.0	27460101

ETIM

ETIM 8.0	EC002643
----------	----------

UNSPSC

UNSPSC 21.0	39121400
-------------	----------

MKDS 5/ 3-9,5 - PCB terminal block



1714984

<https://www.phoenixcontact.com/in/products/1714984>

Environmental Product Compliance

China RoHS	Environmentally friendly use period: unlimited = EFUP-e
	No hazardous substances above threshold values

MKDS 5/ 3-9,5 - PCB terminal block

1714984

<https://www.phoenixcontact.com/in/products/1714984>

Accessories

SZS 0,6X3,5 - Screwdriver

1205053

<https://www.phoenixcontact.com/in/products/1205053>



Actuation tool, for ST terminal blocks, insulated, also suitable for use as a bladed screwdriver, size: 0.6 x 3.5 x 100 mm, 2-component grip, with non-slip grip

MKDS 5/ 2-9,5 - PCB terminal block

1714971

<https://www.phoenixcontact.com/in/products/1714971>

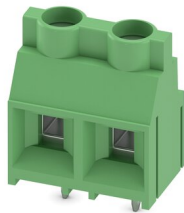

PCB terminal block, nominal current: 32 A, rated voltage (III/2): 1000 V, nominal cross section: 4 mm², number of potentials: 2, number of rows: 1, number of positions per row: 2, product range: MKDS 5, pitch: 9.52 mm, connection method: Screw connection with tension sleeve, screw head form: L Slotted, mounting: Wave soldering, conductor/PCB connection direction: 0 °, color: green, Pin layout: Linear pinning, Solder pin [P]: 5 mm, number of solder pins per potential: 1, type of packaging: packed in cardboard. The article can be aligned to create different nos. of positions!

MKDS 5/ 3-9,5 - PCB terminal block



1714984

<https://www.phoenixcontact.com/in/products/1714984>

MKDS 5/ 3-9,5 - PCB terminal block

1714984

<https://www.phoenixcontact.com/in/products/1714984>



PCB terminal block, nominal current: 32 A, rated voltage (III/2): 1000 V, nominal cross section: 4 mm², number of potentials: 3, number of rows: 1, number of positions per row: 3, product range: MKDS 5, pitch: 9.52 mm, connection method: Screw connection with tension sleeve, mounting: Wave soldering, conductor/PCB connection direction: 0 °, color: green, Pin layout: Linear pinning, Solder pin [P]: 5 mm, number of solder pins per potential: 1, type of packaging: packed in cardboard. The article can be aligned to create different nos. of positions!

Phoenix Contact 2023 © - all rights reserved

<https://www.phoenixcontact.com>

PHOENIX CONTACT (I) Pvt. Ltd.

A-58/2, Okhla Industrial Area, Phase - II, New Delhi-110 020

+91.1275.71420

info@phoenixcontact.co.in