

# HC-B 10-I-UT-M - Contact insert



1648173

<https://www.phoenixcontact.com/in/products/1648173>

Please be informed that the data shown in this PDF document is generated from our Online Catalog. Please find the complete data in the user documentation. Our General Terms of Use for Downloads are valid.

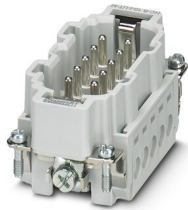

Contact insert, number of positions: 10+PE, size: B10, number of connections per position: 1, Pin, Screw connection, 500 V, 16 A, 0.5 mm<sup>2</sup> ... 2.5 mm<sup>2</sup>, application: Power

## Your advantages

- For fast coding with plastic profile
- For test pin 2 mm

## Commercial Data

Item number	1648173
Packing unit	1 pc
Minimum order quantity	1 pc
Sales Key	BF7
Product Key	BF7ABC
Catalog Page	Page 543 (C-2-2019)
GTIN	4046356092296
Weight per Piece (including packing)	62.2 g
Weight per Piece (excluding packing)	62.2 g
Customs tariff number	85366990
Country of origin	CN

# HC-B 10-I-UT-M - Contact insert

1648173

<https://www.phoenixcontact.com/in/products/1648173>

## Technical Data

### Notes

General	for flexible conductors with or without ferrules
General	Connectors may be operated only when there is no load/voltage.

### Mounting

Assembly instructions	To ensure correct use, installation in housing with IP54 protection or better is required
Connection method	Screw connection

### Product properties

Type	B10
Product type	Contact insert with a fixed no. of positions
Number of positions	10
Connection profile	10+PE
Contact numbering	1 - 10
Application	Power
Number of connections per position	1
Contact type	turned
Series	HC-B
Screwdriver blade	0.5 x 3.5 mm

### Insulation characteristics

Overvoltage category	III
Degree of pollution	3

### Dimensions

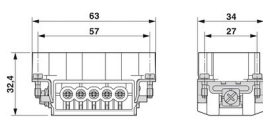
Dimensional drawing	
Width	34 mm
Height	32 mm
Length	64 mm
Drill hole distance, horizontal	57 mm
Drill hole distance, vertical	27 mm

### Mechanical characteristics

Contact diameter	2.5 mm
------------------	--------

### Connection data

Connection technology	
Connection technology	Screw connection

# HC-B 10-I-UT-M - Contact insert



1648173

<https://www.phoenixcontact.com/in/products/1648173>

Number of connections per position	1
Connection in acc. with standard	IEC / EN

## Conductor connection

Conductor cross section	0.5 mm <sup>2</sup> ... 2.5 mm <sup>2</sup>
Connection cross section AWG	20 ... 14
Tightening torque	0.8 Nm ... 1.2 Nm (PE connection)
	0.5 Nm ... 0.8 Nm (Mounting screws for mounting in the HEAVYCON housing)
	0.5 Nm ... 0.8 Nm
Stripping length of the individual wire	8 mm

## Electrical properties

Rated voltage (III/3)	500 V
Rated surge voltage	6 kV
Rated current	16 A
SCCR	5 kA (UL 2237)

## Mechanical properties

### Mechanical data

Insertion/withdrawal cycles	≥ 500
-----------------------------	-------

## Material specifications

Flammability rating according to UL 94	V0
Contact material	Copper alloy
Contact surface material	Ag
Contact carrier material	PC
Standards/regulations	PC: Fire protection in rail vehicles - requirement sets R22, R23, and R24 acc. to DIN EN 45545-2 (Risk level HL1 - HL3)

## Environmental and real-life conditions

### Ambient conditions

Ambient temperature (operation)	-40 °C ... 125 °C (including heating up of contacts)
---------------------------------	--

## Standards and regulations

Constructional and testing regulations	DIN EN 61984
	DIN EN 60664
	IEC 60352
Tests	DIN EN 61984
	DIN EN 60664
	IEC 60352

### Testing

Standards/regulations	PC: Fire protection in rail vehicles - requirement sets R22, R23, and R24 acc. to DIN EN 45545-2 (Risk level HL1 - HL3)
-----------------------	---

# HC-B 10-I-UT-M - Contact insert

1648173

<https://www.phoenixcontact.com/in/products/1648173>



## Drawings

Schematic diagram

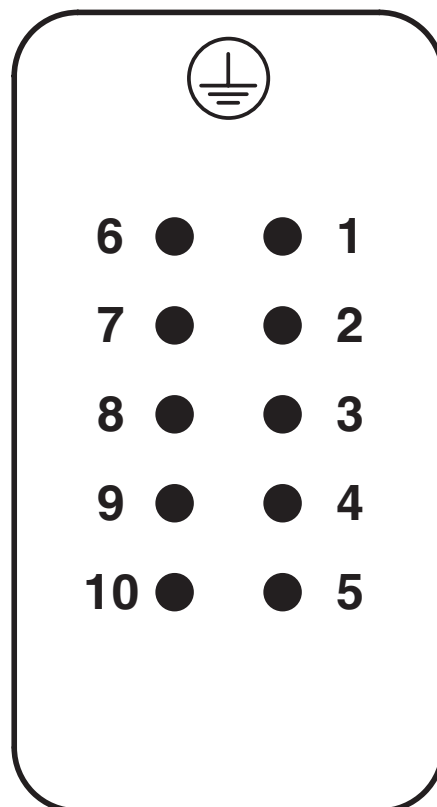

Connector pin assignment, connection side

# HC-B 10-I-UT-M - Contact insert

1648173

<https://www.phoenixcontact.com/in/products/1648173>

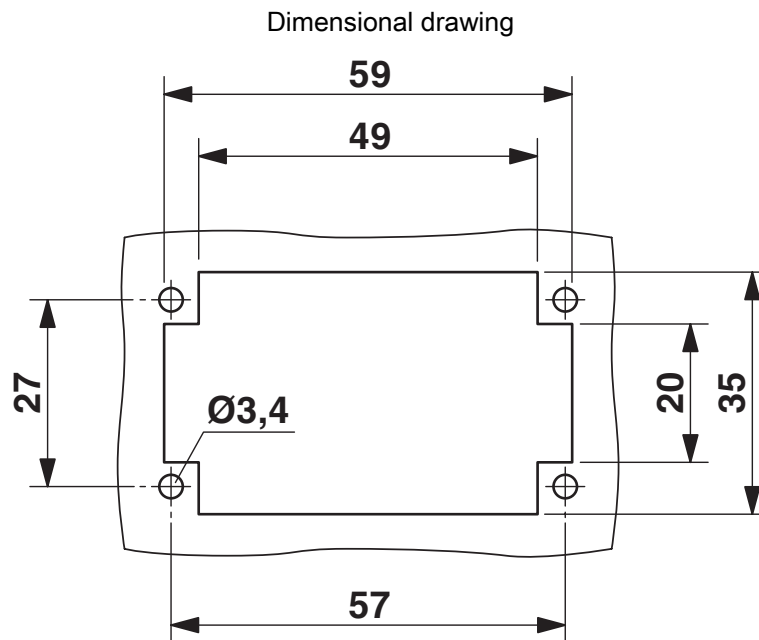

Mounting cutout when used without housing

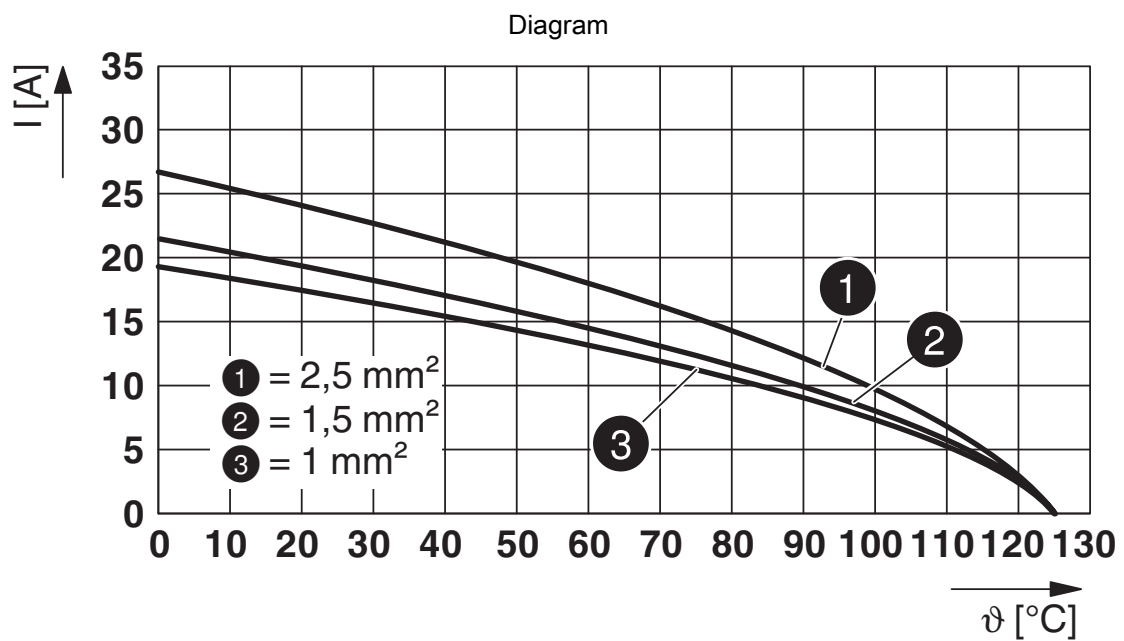

Derating diagram

# HC-B 10-I-UT-M - Contact insert

1648173

<https://www.phoenixcontact.com/in/products/1648173>



Dimensional drawing

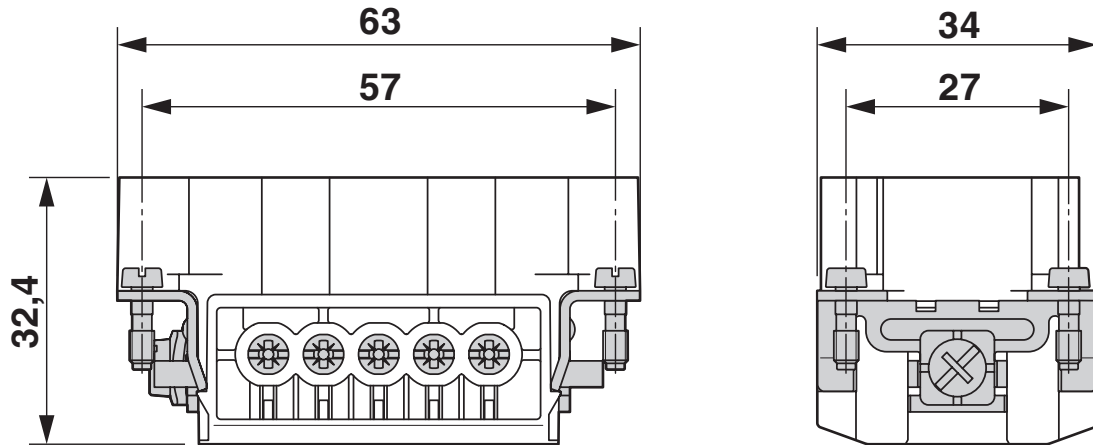

Male insert

# HC-B 10-I-UT-M - Contact insert



1648173

<https://www.phoenixcontact.com/in/products/1648173>

## Approvals

 <b>CSA</b> Approval ID: 013631_6233_01				
	Nominal Voltage $U_N$	Nominal Current $I_N$	Cross Section AWG	Cross Section $\text{mm}^2$
	600 V	13 A	22 - 14	-

 <b>UL Recognized</b> Approval ID: FILE E 118976				
	Nominal Voltage $U_N$	Nominal Current $I_N$	Cross Section AWG	Cross Section $\text{mm}^2$
	600 V	16 A	- 14	-

 <b>EAC</b> Approval ID: RU C-DE.AI30.B.01102				
---	--	--	--	--

 <b>cULus Recognized</b> Approval ID: E468743				
	Nominal Voltage $U_N$	Nominal Current $I_N$	Cross Section AWG	Cross Section $\text{mm}^2$
	600 V	14 A	- 14	-

 <b>EAC</b> Approval ID: RU C-DE.BL08.B.00511				
---	--	--	--	--

# HC-B 10-I-UT-M - Contact insert



1648173

<https://www.phoenixcontact.com/in/products/1648173>

## Classifications

### ECLASS

ECLASS-11.0	27440205
ECLASS-12.0	27440205
ECLASS-13.0	27440205

### ETIM

ETIM 8.0	EC000438
----------	----------

### UNSPSC

UNSPSC 21.0	39121500
-------------	----------



# HC-B 10-I-UT-M - Contact insert



1648173

<https://www.phoenixcontact.com/in/products/1648173>

## Environmental Product Compliance

REACH SVHC	Lead 7439-92-1
China RoHS	Environmentally Friendly Use Period = 50 years
	For information on hazardous substances, refer to the manufacturer's declaration available under "Downloads"

# HC-B 10-I-UT-M - Contact insert

1648173

<https://www.phoenixcontact.com/in/products/1648173>



## Accessories

### CP-HC - Coding profile

1686478

<https://www.phoenixcontact.com/in/products/1686478>



Coding profile, 4 coding profiles per strip, for insertion in coding keyways

---

### HC-CB - Coding bolt

1772722

<https://www.phoenixcontact.com/in/products/1772722>



Coding pin, prevents mismatching of up to six connectors with an identical number of positions

# HC-B 10-I-UT-M - Contact insert

1648173

<https://www.phoenixcontact.com/in/products/1648173>



## HC-CST - Coding element

1676857

<https://www.phoenixcontact.com/in/products/1676857>



Coding peg for coding up to 16 connectors

---

## HC-CBU - Coding element

1676860

<https://www.phoenixcontact.com/in/products/1676860>



Coding socket for coding up to 16 connectors

# HC-B 10-I-UT-M - Contact insert

1648173

<https://www.phoenixcontact.com/in/products/1648173>



## HC-B-PE-PT - Adapter

1054672

<https://www.phoenixcontact.com/in/products/1054672>



PE adapter with PT connection, for 1 PE connection, for HC-B / HC-BB / HC-DD / HC-D40 / HC-D64 contact inserts

---

## HC-B-2PE-PT - PE multiplier

1054675

<https://www.phoenixcontact.com/in/products/1054675>

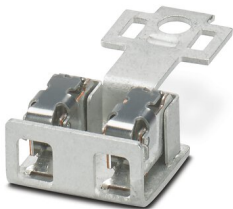

PE adapter with PT connection, for 2 PE connections, for HC-B / HC-BB / HC-DD / HC-D40 / HC-D64 contact inserts

# HC-B 10-I-UT-M - Contact insert

1648173

<https://www.phoenixcontact.com/in/products/1648173>



## HC-B-3PE - PE multiplier

1644326

<https://www.phoenixcontact.com/in/products/1644326>



PE multiplier, for 3 PE connections, for HC-B / HC-BB / HC-DD / HC-D40 / HC-D64 contact inserts

---

## HC-B-PES - Screw

1604997

<https://www.phoenixcontact.com/in/products/1604997>



PE screw, for contact inserts HC-B / HC-BB / HC-DD / HC-D40 / HC-D64

# HC-B 10-I-UT-M - Contact insert

1648173

<https://www.phoenixcontact.com/in/products/1648173>



## HC-B-ZG - Strain relief clamp

1685327

<https://www.phoenixcontact.com/in/products/1685327>



Strain relief clamps contact inserts of series: B-, BB-, D 40, D 64, DD and HV, straight cable exit

---

## HC-B-ZS - Strain relief clamp

1685330

<https://www.phoenixcontact.com/in/products/1685330>



Strain relief clamps contact inserts of series: B-, BB-, D 40, D 64, DD and HV, lateral cable exit

# HC-B 10-I-UT-M - Contact insert

1648173

<https://www.phoenixcontact.com/in/products/1648173>



## HC-CIF-B10-HFWL-PL - DIN rail mounting frame

1424335

<https://www.phoenixcontact.com/in/products/1424335>



DIN rail mounting frame, design: B10, for contact inserts, Top frame

---

## HC-B 10-ANDOCK - Docking frame

1586125

<https://www.phoenixcontact.com/in/products/1586125>



Docking frame for racks, for contact inserts of B10 type, with four M5 flat headed screws, rack balance x/y axis  $\pm 1.5$  mm

# HC-B 10-I-UT-M - Contact insert

1648173

<https://www.phoenixcontact.com/in/products/1648173>



## HC-CIF-B06-24-BFAFL-PL - DIN rail mounting frame

1424338

<https://www.phoenixcontact.com/in/products/1424338>

DIN rail mounting frame, design: B6 - B24, for contact inserts, Base frame



---

## HC-B24/10-ADP-SS - Adapter plate

1034213

<https://www.phoenixcontact.com/in/products/1034213>

Adapter plate, design: B24 to B10





# HC-B 10-I-UT-M - Contact insert

1648173

<https://www.phoenixcontact.com/in/products/1648173>



## HC-B 10-I-UT-F - Contact insert

1648186

<https://www.phoenixcontact.com/in/products/1648186>

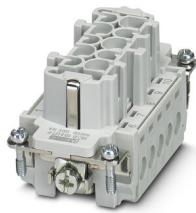

Contact insert, number of positions: 10+PE, size: B10, number of connections per position: 1, Socket, Screw connection, 500 V, 16 A, 0.5 mm<sup>2</sup> ... 2.5 mm<sup>2</sup>, application: Power

---

Phoenix Contact 2023 © - all rights reserved

<https://www.phoenixcontact.com>

PHOENIX CONTACT (I) Pvt. Ltd.

A-58/2, Okhla Industrial Area, Phase - II, New Delhi-110 020

+91.1275.71420

[info@phoenixcontact.co.in](mailto:info@phoenixcontact.co.in)