

HC-B 24-I-UT-M-48 - Contact insert



1584936

<https://www.phoenixcontact.com/in/products/1584936>

Please be informed that the data shown in this PDF document is generated from our Online Catalog. Please find the complete data in the user documentation. Our General Terms of Use for Downloads are valid.

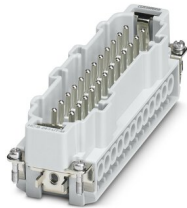

Contact insert, number of positions: 24+PE, size: B24, Pin, Screw connection, 500 V, 16 A, 0.5 mm² ... 2.5 mm²

Your advantages

- For fast coding with plastic profile
- For test pin 2 mm

Commercial Data

Item number	1584936
Packing unit	1 pc
Minimum order quantity	1 pc
Sales Key	BF7
Product Key	BF7ABC
Catalog Page	Page 547 (C-2-2019)
GTIN	4046356156141
Weight per Piece (including packing)	111.5 g
Weight per Piece (excluding packing)	111.5 g
Customs tariff number	85366990
Country of origin	CN

HC-B 24-I-UT-M-48 - Contact insert



1584936

<https://www.phoenixcontact.com/in/products/1584936>

Technical Data

Notes

General	for flexible conductors with or without ferrules
General	Connectors may be operated only when there is no load/voltage.

Mounting

Assembly instructions	To ensure correct use, installation in housing with IP54 protection or better is required
-----------------------	---

Product properties

Type	B24 B48
Product type	Contact insert with a fixed no. of positions
Number of positions	24
Connection profile	24+PE
Contact numbering	25 - 48
Contact type	turned
Series	HC-B
Screwdriver blade	0.5 x 3.5 mm

Insulation characteristics

Overvoltage category	III
Degree of pollution	3

Dimensions

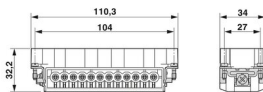
Dimensional drawing	
Width	34 mm
Height	32 mm
Length	111 mm
Drill hole distance, horizontal	104 mm
Drill hole distance, vertical	27 mm

Mechanical characteristics

Contact diameter	2.5 mm
------------------	--------

Connection data

Connection technology

Connection technology	Screw connection
Connection in acc. with standard	IEC / EN

Conductor connection

HC-B 24-I-UT-M-48 - Contact insert



1584936

<https://www.phoenixcontact.com/in/products/1584936>

Conductor cross section	0.5 mm ² ... 2.5 mm ²
Connection cross section AWG	20 ... 14
Tightening torque	0.8 Nm ... 1.2 Nm (PE connection)
	0.5 Nm ... 0.8 Nm (Mounting screws for mounting in the HEAVYCON housing)
	0.5 Nm ... 0.8 Nm
Stripping length of the individual wire	8 mm

Electrical properties

Rated voltage (III/3)	500 V
Rated surge voltage	6 kV
Rated current	16 A
SCCR	5 kA (UL 2237)

Mechanical properties

Mechanical data

Insertion/withdrawal cycles	≥ 500
-----------------------------	-------

Material specifications

Flammability rating according to UL 94	V0
Contact material	Copper alloy
Contact surface material	Ag
Contact carrier material	PC
Standards/regulations	PC: Fire protection in rail vehicles - requirement sets R22, R23, and R24 acc. to DIN EN 45545-2 (Risk level HL1 - HL3)

Environmental and real-life conditions

Ambient conditions

Ambient temperature (operation)	-40 °C ... 125 °C (including heating up of contacts)
---------------------------------	--

Standards and regulations

Constructional and testing regulations	DIN EN 61984
	DIN EN 60664
	IEC 60352
Tests	DIN EN 61984
	DIN EN 60664
	IEC 60352

Testing

Standards/regulations	PC: Fire protection in rail vehicles - requirement sets R22, R23, and R24 acc. to DIN EN 45545-2 (Risk level HL1 - HL3)
-----------------------	---

HC-B 24-I-UT-M-48 - Contact insert

1584936

<https://www.phoenixcontact.com/in/products/1584936>

Drawings

Dimensional drawing

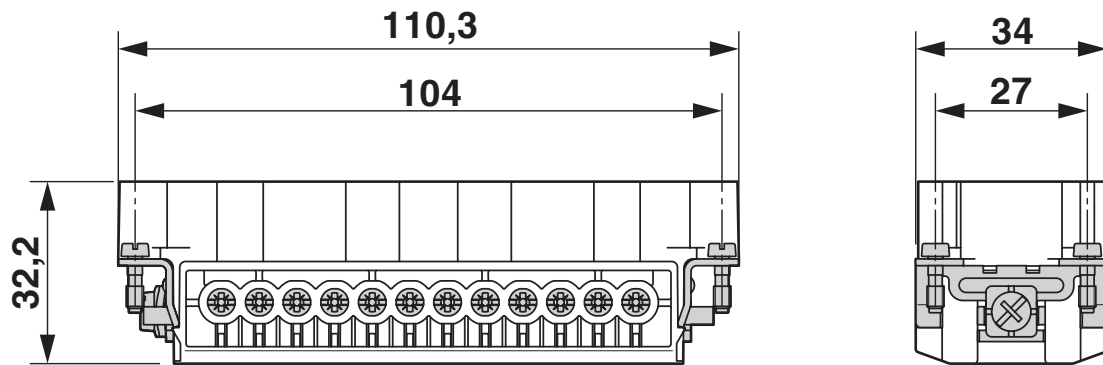

Male insert

Schematic diagram

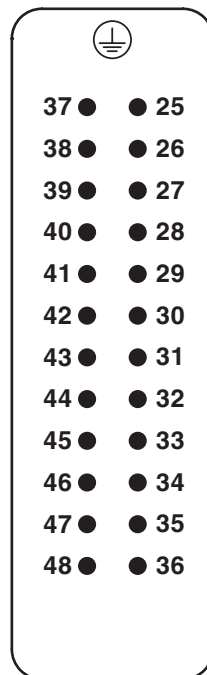

Connector pin assignment, connection side

HC-B 24-I-UT-M-48 - Contact insert

1584936

<https://www.phoenixcontact.com/in/products/1584936>

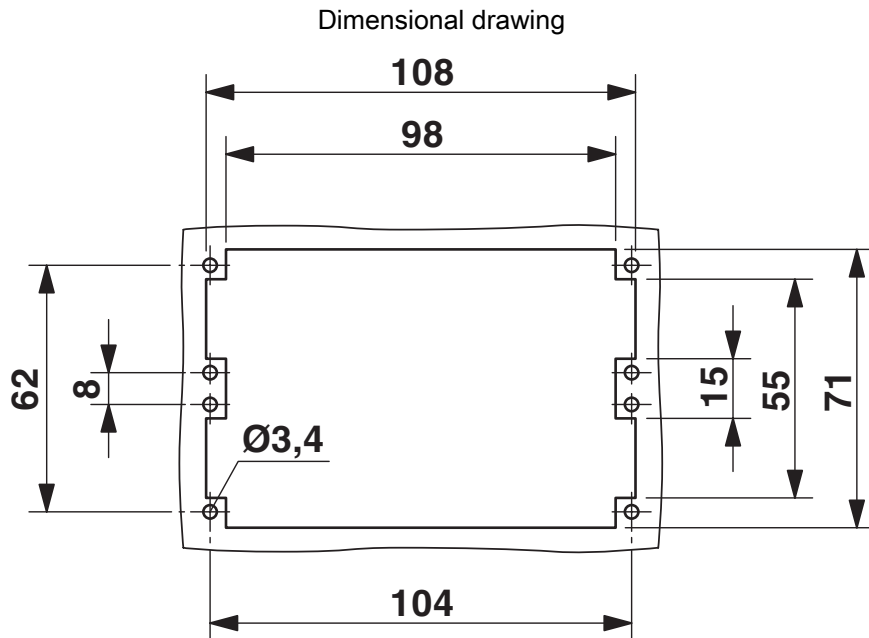

Mounting cutout when used without housing

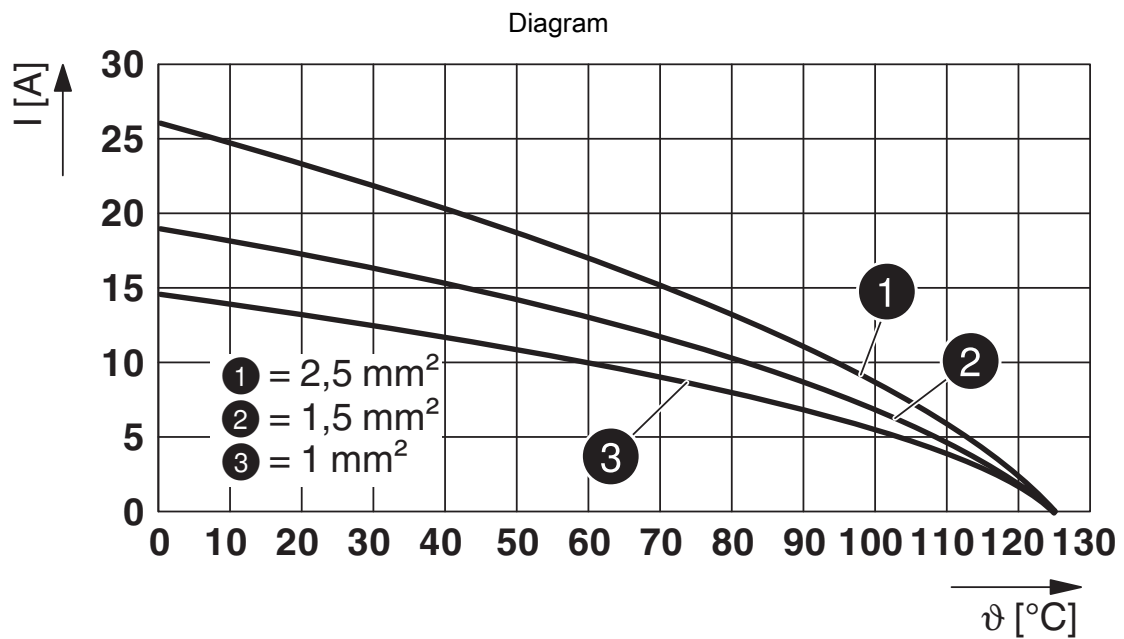

Derating diagram

HC-B 24-I-UT-M-48 - Contact insert



1584936

<https://www.phoenixcontact.com/in/products/1584936>

Approvals

 CSA Approval ID: 013631_6233_01	Nominal Voltage U_N	Nominal Current I_N	Cross Section AWG	Cross Section mm^2
	600 V	13 A	22 - 14	-

 UL Recognized Approval ID: FILE E 118976	Nominal Voltage U_N	Nominal Current I_N	Cross Section AWG	Cross Section mm^2
	600 V	16 A	- 14	-

 EAC Approval ID: RU C-DE.AI30.B.01102

 cULus Recognized Approval ID: E468743	Nominal Voltage U_N	Nominal Current I_N	Cross Section AWG	Cross Section mm^2
	600 V	14 A	- 14	-

 EAC Approval ID: RU C-DE.BL08.B.00511

HC-B 24-I-UT-M-48 - Contact insert



1584936

<https://www.phoenixcontact.com/in/products/1584936>

Classifications

ECLASS

ECLASS-11.0	27440205
ECLASS-12.0	27440205
ECLASS-13.0	27440205

ETIM

ETIM 8.0	EC000438
----------	----------

UNSPSC

UNSPSC 21.0	39121500
-------------	----------

HC-B 24-I-UT-M-48 - Contact insert



1584936

<https://www.phoenixcontact.com/in/products/1584936>

Environmental Product Compliance

REACH SVHC	Lead 7439-92-1
China RoHS	Environmentally Friendly Use Period = 50 years
	For information on hazardous substances, refer to the manufacturer's declaration available under "Downloads"

HC-B 24-I-UT-M-48 - Contact insert



1584936

<https://www.phoenixcontact.com/in/products/1584936>

Accessories

CP-HC - Coding profile

1686478

<https://www.phoenixcontact.com/in/products/1686478>

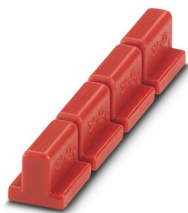

Coding profile, 4 coding profiles per strip, for insertion in coding keyways

HC-CB - Coding bolt

1772722

<https://www.phoenixcontact.com/in/products/1772722>



Coding pin, prevents mismatching of up to six connectors with an identical number of positions

HC-B 24-I-UT-M-48 - Contact insert

1584936

<https://www.phoenixcontact.com/in/products/1584936>



HC-CST - Coding element

1676857

<https://www.phoenixcontact.com/in/products/1676857>



Coding peg for coding up to 16 connectors

HC-CBU - Coding element

1676860

<https://www.phoenixcontact.com/in/products/1676860>



Coding socket for coding up to 16 connectors

HC-B 24-I-UT-M-48 - Contact insert

1584936

<https://www.phoenixcontact.com/in/products/1584936>



HC-B-PE-PT - Adapter

1054672

<https://www.phoenixcontact.com/in/products/1054672>



PE adapter with PT connection, for 1 PE connection, for HC-B / HC-BB / HC-DD / HC-D40 / HC-D64 contact inserts

HC-B-2PE-PT - PE multiplier

1054675

<https://www.phoenixcontact.com/in/products/1054675>



PE adapter with PT connection, for 2 PE connections, for HC-B / HC-BB / HC-DD / HC-D40 / HC-D64 contact inserts

HC-B 24-I-UT-M-48 - Contact insert

1584936

<https://www.phoenixcontact.com/in/products/1584936>



HC-B-3PE - PE multiplier

1644326

<https://www.phoenixcontact.com/in/products/1644326>



PE multiplier, for 3 PE connections, for HC-B / HC-BB / HC-DD / HC-D40 / HC-D64 contact inserts

HC-B-PES - Screw

1604997

<https://www.phoenixcontact.com/in/products/1604997>



PE screw, for contact inserts HC-B / HC-BB / HC-DD / HC-D40 / HC-D64

HC-B 24-I-UT-M-48 - Contact insert

1584936

<https://www.phoenixcontact.com/in/products/1584936>



HC-B-ZG - Strain relief clamp

1685327

<https://www.phoenixcontact.com/in/products/1685327>



Strain relief clamps contact inserts of series: B-, BB-, D 40, D 64, DD and HV, straight cable exit

HC-B-ZS - Strain relief clamp

1685330

<https://www.phoenixcontact.com/in/products/1685330>



Strain relief clamps contact inserts of series: B-, BB-, D 40, D 64, DD and HV, lateral cable exit

HC-B 24-I-UT-M-48 - Contact insert

1584936

<https://www.phoenixcontact.com/in/products/1584936>



HC-CIF-B24-HFWL-PL - DIN rail mounting frame

1424337

<https://www.phoenixcontact.com/in/products/1424337>



DIN rail mounting frame, design: B24, for contact inserts, Top frame

HC-B 24-ANDOCK - Docking frame

1586141

<https://www.phoenixcontact.com/in/products/1586141>

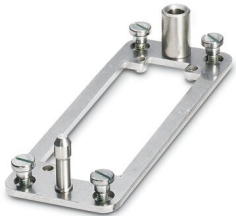

Docking frame for racks, for contact inserts of B24 type, with four M5 flat headed screws, rack balance x/y axis ± 1.5 mm

HC-B 24-I-UT-M-48 - Contact insert

1584936

<https://www.phoenixcontact.com/in/products/1584936>



HC-CIF-B06-24-BFAFL-PL - DIN rail mounting frame

1424338

<https://www.phoenixcontact.com/in/products/1424338>



DIN rail mounting frame, design: B6 - B24, for contact inserts, Base frame

HC-B 24-I-UT-F-48 - Contact insert

1584949

<https://www.phoenixcontact.com/in/products/1584949>

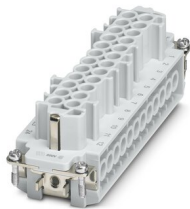

Contact insert, number of positions: 24+PE, size: B24, Socket, Screw connection, 500 V, 16 A, 0.5 mm² ... 2.5 mm², application: Power

Phoenix Contact 2023 © - all rights reserved
<https://www.phoenixcontact.com>

PHOENIX CONTACT (I) Pvt. Ltd.
A-58/2, Okhla Industrial Area, Phase - II, New Delhi-110 020

+91.1275.71420
info@phoenixcontact.co.in