

CUC-IND-C1ZNI-S/R4IP8 - RJ45 connector



1421126

<https://www.phoenixcontact.com/pc/products/1421126>

Please be informed that the data shown in this PDF document is generated from our Online Catalog. Please find the complete data in the user documentation. Our General Terms of Use for Downloads are valid.



RJ45 connector, design: RJ45, degree of protection: IP20, number of positions: 8, 1 Gbps, CAT5, material: Metal, connection method: Insulation displacement connection, connection cross section: AWG 23- 22, cable outlet: straight, color: green, Ethernet/PROFINET

Your advantages

- Easy and time-saving assembly with IDC fast connection technology
- Can be used internationally due to EAC, UL 1863, and CAN/CSA C22.2
- Ideal companion for servicing or repairs in the field: no special tools required for mounting

Commercial Data

Item number	1421126
Packing unit	1 pc
Minimum order quantity	1 pc
Product Key	ABNAAA
Catalog Page	Page 373 (C-2-2019)
GTIN	4055626254654
Weight per Piece (including packing)	18.05 g
Weight per Piece (excluding packing)	12.894 g
Customs tariff number	85366990
Country of origin	PL

CUC-IND-C1ZNI-S/R4IP8 - RJ45 connector



1421126

<https://www.phoenixcontact.com/pc/products/1421126>

Technical Data

Product properties

Type	RJ45
Product type	Data connector (cable side)
Number of positions	8
Sensor type	Ethernet/PROFINET
Connection profile	RJ45
No. of cable outlets	1
Type	RJ45
Locking type	Locking clips
Shielded	yes
Cable outlet	straight

Insulation characteristics

Overvoltage category	I
Degree of pollution	2

Electrical properties

Min. AWG, flexible, multi-strand	23
Rated voltage (III/3)	72 V (DC)
Rated current	1.75 A
Contact resistance	< 100 m Ω (max.)
Frequency range	to 100 MHz
Insulation resistance	> 500 M Ω
Nominal voltage U_N	48 V
Nominal current I_N	1.75 A
Contact resistance per contact pair	< 20 Ω
Contact resistance	> 10 m Ω (Wire – IDC) 0.005 Ω (Litz wires – IDC)
Transmission medium	Copper
Transmission characteristics (category)	CAT5
Transmission speed	1 Gbps
Power transmission	PoE++

Dimensions

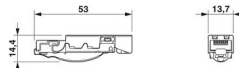
Dimensional drawing	
Width	13.65 mm
Height	14.4 mm
Length	53 mm

1421126

<https://www.phoenixcontact.com/pc/products/1421126>

Material specifications

Color	green
Material	Plastic
Flammability rating according to UL 94	V0
Housing surface material	Ni
Cable seal material	NBR
Contact material	CuSn
Contact surface material	Au/Ni
Contact carrier material	PC
O-ring material	FPM
Locking latch material	Stainless steel
Housing material	Metal

Cable/line

External cable diameter	5 mm ... 9 mm
	5 mm ... 9 mm
Wire diameter including insulation	≤ 1.6 mm
Test voltage Core/Core	1000 V
Test voltage Core/Shield	1500 V
Wave impedance	100 Ω

Mechanical properties

Mechanical data

Insertion/withdrawal cycles	≥ 750
Insertion force per signal contact	< 20.00 N
Extraction force per signal contact	< 20 N

Environmental and real-life conditions

Ambient conditions

Degree of protection	IP20
Ambient temperature (operation)	-40 °C ... 70 °C
Ambient temperature (storage/transport)	-40 °C ... 70 °C

Mounting

Mounting type	For field assembly
Connection method	Insulation displacement connection

CUC-IND-C1ZNI-S/R4IP8 - RJ45 connector



1421126

<https://www.phoenixcontact.com/pc/products/1421126>

Drawings

Dimensional drawing

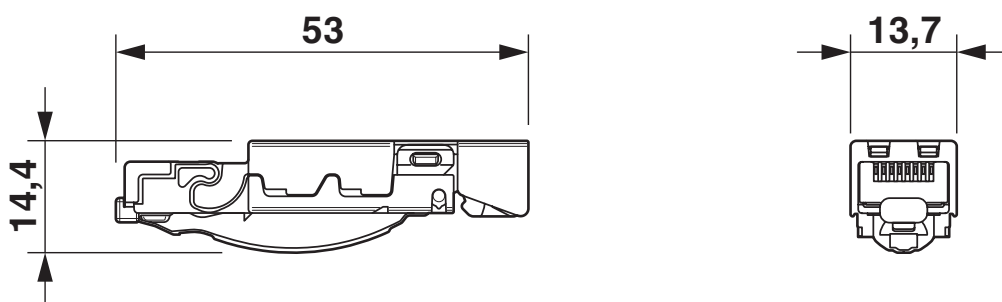

RJ45 connector, IP20

CUC-IND-C1ZNI-S/R4IP8 - RJ45 connector



1421126

<https://www.phoenixcontact.com/pc/products/1421126>

Approvals



EAC

Approval ID: B.01687



cULus Recognized

Approval ID: E335024-20170228

	Nominal Voltage U_N	Nominal Current I_N	Cross Section AWG	Cross Section mm^2
	56.5 V	0.175 A	-	-

CUC-IND-C1ZNI-S/R4IP8 - RJ45 connector



1421126

<https://www.phoenixcontact.com/pc/products/1421126>

Classifications

ECLASS

ECLASS-11.0	27440102
ECLASS-12.0	27440116
ECLASS-13.0	27440116

ETIM

ETIM 8.0	EC002636
----------	----------

UNSPSC

UNSPSC 21.0	39121400
-------------	----------

CUC-IND-C1ZNI-S/R4IP8 - RJ45 connector



1421126

<https://www.phoenixcontact.com/pc/products/1421126>

Environmental Product Compliance

China RoHS	Environmentally friendly use period: unlimited = EFUP-e
	No hazardous substances above threshold values

CUC-IND-C1ZNI-S/R4IP8 - RJ45 connector

1421126

<https://www.phoenixcontact.com/pc/products/1421126>

Accessories

VS-CABLE-STRIP-VARIO - Stripping tool

1657407

<https://www.phoenixcontact.com/pc/products/1657407>

Stripping tool, for the multi-level stripping of shielded cables



MICROFOX-SP-1 - Diagonal cutter

1212487

<https://www.phoenixcontact.com/pc/products/1212487>

Electronic diagonal cutter, tapered head, without chamfer, with opening spring, non-reflective phosphate-treated surface, punched version



CUC-IND-C1ZNI-S/R4IP8 - RJ45 connector



1421126

<https://www.phoenixcontact.com/pc/products/1421126>

TMT 5 R - Marker for terminal blocks

0816430

<https://www.phoenixcontact.com/pc/products/0816430>



Marker for terminal blocks, Roll, white, unlabeled, can be labeled with: THERMOMARK E.300 (D)/600 (D), THERMOMARK ROLL 2.0, THERMOMARK ROLL, THERMOMARK ROLL X1, THERMOMARK ROLLMASTER 300/600, THERMOMARK X1.2, perforated, mounting type: snapped, snap into flat marker groove, for terminal block width: 5.2 mm, lettering field size: 6.4 x 5.15 mm, Number of individual labels: 19000

UCT-TMF 5 OG - Marker for terminal blocks

0829190

<https://www.phoenixcontact.com/pc/products/0829190>

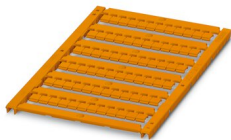

Marker for terminal blocks, Sheet, orange, unlabeled, can be labeled with: TOPMARK NEO, TOPMARK LASER, BLUEMARK ID COLOR, BLUEMARK ID, BLUEMARK CLED, THERMOMARK PRIME, THERMOMARK CARD 2.0, THERMOMARK CARD, mounting type: snapped, for terminal block width: 5.2 mm, lettering field size: 4.4 x 4.7 mm, Number of individual labels: 72

CUC-IND-C1ZNI-S/R4IP8 - RJ45 connector

1421126

<https://www.phoenixcontact.com/pc/products/1421126>

VS-OE-OE-93B-100,0 - Data cable

1416389

<https://www.phoenixcontact.com/pc/products/1416389>



Data cable, PROFINET CAT5 (100 Mbps), 4-position, shielded, free cable end, on free cable end, cable length: 100 m

VS-OE-OE-93B/... - Data cable

1417362

<https://www.phoenixcontact.com/pc/products/1417362>



Data cable, PROFINET CAT5 (100 Mbps), 4-position, shielded, free cable end, on free cable end, cable length: Free entry (0.5 ... 400 m)

CUC-IND-C1ZNI-S/R4IP8 - RJ45 connector



1421126

<https://www.phoenixcontact.com/pc/products/1421126>

VS-PP-F-RJ45-CAT6 - DIN rail adapter

1658118

<https://www.phoenixcontact.com/pc/products/1658118>

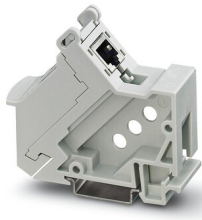

DIN rail adapter, degree of protection: IP20, number of positions: 8, 1 Gbps, CAT6, material: PC-GF, connection method: IDC fast connection, connection cross section: AWG 24- 22, color: gray

CUC-PP-D1PGY/R4GC8 - DIN rail adapter

1418094

<https://www.phoenixcontact.com/pc/products/1418094>

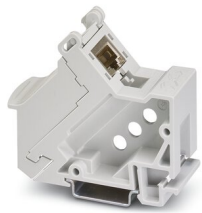

DIN rail adapter, design: RJ45, degree of protection: IP20, number of positions: 8, 1 Gbps, CAT6, material: PC-GF, connection method: Coupling, color: gray

CUC-IND-C1ZNI-S/R4IP8 - RJ45 connector

1421126

<https://www.phoenixcontact.com/pc/products/1421126>

CUC-F-J1ZNI-S/R4IDC8 - RJ45 socket insert

1418984

<https://www.phoenixcontact.com/pc/products/1418984>

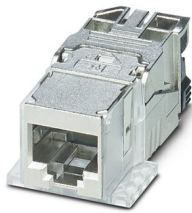

RJ45 socket insert, design: RJ45, degree of protection: IP20, number of positions: 8, 10 Gbps, CAT6_A, material: Metal, connection method: IDC connection, connection cross section: AWG 26- 22, cable outlet: straight, Freenet design for use with IP67 panel mounting frame and terminal outlets, Ethernet

CUC-K-J1ZNI-S/R4IDC8 - RJ45 socket insert

1419021

<https://www.phoenixcontact.com/pc/products/1419021>



RJ45 socket insert, design: RJ45, degree of protection: IP20, number of positions: 8, 10 Gbps, CAT6_A, material: Metal, connection method: IDC connection, connection cross section: AWG 26- 22, cable outlet: straight, Keystone design for use with IP20 panel mounting frame or integrated directly into the housing panel, Ethernet

CUC-IND-C1ZNI-S/R4IP8 - RJ45 connector

1421126

<https://www.phoenixcontact.com/pc/products/1421126>

VS-OE-OE-937/... - Data cable

1402687

<https://www.phoenixcontact.com/pc/products/1402687>



Data cable, PROFINET CAT5 (100 Mbps), 4-position halogen-free, shielded, free cable end, on free cable end, cable length: Free entry (0.5 ... 400 m)

VS-OE-OE-93R/... - Data cable

1417388

<https://www.phoenixcontact.com/pc/products/1417388>



Data cable, PROFINET CAT5 (100 Mbps), 4-position halogen-free, shielded, free cable end, on free cable end, cable length: Free input (0.5 ... 100 m)

CUC-IND-C1ZNI-S/R4IP8 - RJ45 connector

1421126

<https://www.phoenixcontact.com/pc/products/1421126>

VS-93A/... - Data cable

1416486

<https://www.phoenixcontact.com/pc/products/1416486>

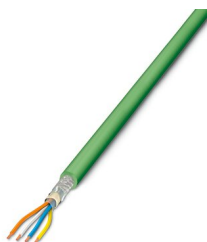

Data cable, PROFINET CAT5 (100 Mbps), 4-position, free cable end, on free cable end

VS-OE-OE-93C/... - Data cable

1417491

<https://www.phoenixcontact.com/pc/products/1417491>



Data cable, PROFINET CAT5 (100 Mbps), 4-position halogen-free, shielded, free cable end, on free cable end, cable length: Free entry (0.5 ... 400 m)

CUC-IND-C1ZNI-S/R4IP8 - RJ45 connector



1421126

<https://www.phoenixcontact.com/pc/products/1421126>

UCT-TMF 5 GN - Marker for terminal blocks

0829193

<https://www.phoenixcontact.com/pc/products/0829193>

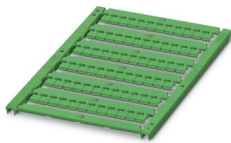

Marker for terminal blocks, Sheet, green, unlabeled, can be labeled with: TOPMARK NEO, TOPMARK LASER, BLUEMARK ID COLOR, BLUEMARK ID, BLUEMARK CLED, THERMOMARK PRIME, THERMOMARK CARD 2.0, THERMOMARK CARD, mounting type: snapped, for terminal block width: 5.2 mm, lettering field size: 4.4 x 4.7 mm, Number of individual labels: 72

UCT-TMF 5 RD - Marker for terminal blocks

0829189

<https://www.phoenixcontact.com/pc/products/0829189>

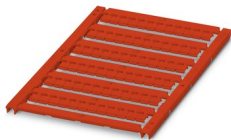

Marker for terminal blocks, Sheet, red, unlabeled, can be labeled with: TOPMARK NEO, TOPMARK LASER, BLUEMARK ID COLOR, BLUEMARK ID, BLUEMARK CLED, THERMOMARK PRIME, THERMOMARK CARD 2.0, THERMOMARK CARD, mounting type: snapped, for terminal block width: 5.2 mm, lettering field size: 4.4 x 4.7 mm, Number of individual labels: 72

CUC-IND-C1ZNI-S/R4IP8 - RJ45 connector



1421126

<https://www.phoenixcontact.com/pc/products/1421126>

UCT-TMF 5 BU - Marker for terminal blocks

0829192

<https://www.phoenixcontact.com/pc/products/0829192>



Marker for terminal blocks, Sheet, blue, unlabeled, can be labeled with: TOPMARK NEO, TOPMARK LASER, BLUEMARK ID COLOR, BLUEMARK ID, BLUEMARK CLED, THERMOMARK PRIME, THERMOMARK CARD 2.0, THERMOMARK CARD, mounting type: snapped, for terminal block width: 5.2 mm, lettering field size: 4.4 x 4.7 mm, Number of individual labels: 72

UCT-TMF 5 YE - Marker for terminal blocks

0828745

<https://www.phoenixcontact.com/pc/products/0828745>

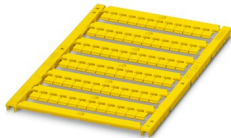

Marker for terminal blocks, Sheet, yellow, unlabeled, can be labeled with: TOPMARK NEO, TOPMARK LASER, BLUEMARK ID COLOR, BLUEMARK ID, BLUEMARK CLED, THERMOMARK PRIME, THERMOMARK CARD 2.0, THERMOMARK CARD, mounting type: snapped, for terminal block width: 5.2 mm, lettering field size: 4.4 x 4.7 mm, Number of individual labels: 72

Phoenix Contact 2023 © - all rights reserved
<https://www.phoenixcontact.com>

PHOENIX CONTACT GmbH & Co. KG
Flachsmarktstraße 8
D-32825 Blomberg
+49 (0) 5235-3 00
info@phoenixcontact.com