

# HC-M-05-PT-M - Contact insert module



1417372

<https://www.phoenixcontact.com/in/products/1417372>

Please be informed that the data shown in this PDF document is generated from our online catalog. Please find the complete data in the user documentation. Our general terms of use for downloads are valid.



Contact insert module, number of positions: 5, power contacts: 5, control contacts: 0, Pin, Push-in connection, 400 V, 16 A, 0.14 mm<sup>2</sup> ... 2.5 mm<sup>2</sup>, application: Power

## Your advantages

- Easy installation without tools, even when mounted, with push-in connection technology
- Shortest installation time compared to other connection technologies
- Quick and effortless wiring, in particular when space is tight
- Automatic cabling with robots possible
- Safe wiring and operation with color-coded actuators
- Shock and vibration-resistant in accordance with DIN EN 61373

## Commercial data

Item number	1417372
Packing unit	5 pc
Minimum order quantity	5 pc
Sales key	BF7
Product key	BF7ACE
Catalog page	Page 577 (C-2-2019)
GTIN	4055626112541
Weight per piece (including packing)	15.4 g
Weight per piece (excluding packing)	14.62 g
Customs tariff number	85366990
Country of origin	PL

# HC-M-05-PT-M - Contact insert module



1417372

<https://www.phoenixcontact.com/in/products/1417372>

## Technical data

### Notes

General	only use flexible conductors with ferrules
General	Connectors may be operated only when there is no load/voltage.
General	For HEAVYCON housing type B6 to B48, HC-M-B...MF-... module carrier frame required

### Mounting

Assembly note	To ensure correct use, installation in housing with IP54 protection or better is required
---------------	---

### Product properties

Product type	Modular contact insert
Series	HC-M-05
Application	Power
Number of positions	5
Connection profile	5
Contact numbering	1 - 5
Number of module slots	1
No. of power contacts	5
No. of control contacts	0
Contact material type	rolled

### Data management status

Article revision	03
------------------	----

### Insulation characteristics

Overvoltage category	III
Degree of pollution	3

### Connection data

#### Connection technology

Connection technology	Push-in connection
-----------------------	--------------------

#### Conductor connection

Conductor cross section	0.14 mm <sup>2</sup> ... 2.5 mm <sup>2</sup>
Connection cross section AWG	26 ... 14
Stripping length of the individual wire	8 mm ±1 mm

### Dimensions

# HC-M-05-PT-M - Contact insert module



1417372

<https://www.phoenixcontact.com/in/products/1417372>

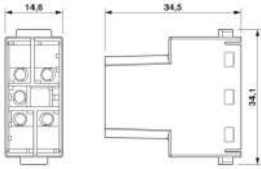
Dimensional drawing	
Width	34.2 mm
Height	35.5 mm
Length	14.6 mm

Mechanical characteristics	
Minimum housing height	52 mm
Contact diameter	2.5 mm

## Electrical properties

Rated voltage (III/3)	400 V
Rated surge voltage	4 kV
Rated current	16 A

## Mechanical properties

Mechanical data	
Insertion/withdrawal cycles	≥ 500

## Material specifications

Flammability rating according to UL 94	V0
Contact material	Copper alloy
Contact surface material	Ag
Contact carrier material	PC
Standards/regulations	PC: Fire protection in rail vehicles - requirement sets R22, R23, and R24 acc. to DIN EN 45545-2 (Risk level HL1 - HL3)

## Environmental and real-life conditions

Ambient conditions	
Ambient temperature (operation)	-40 °C ... 125 °C

## Standards and regulations

Testing	
Standards/regulations	PC: Fire protection in rail vehicles - requirement sets R22, R23, and R24 acc. to DIN EN 45545-2 (Risk level HL1 - HL3)

# HC-M-05-PT-M - Contact insert module



1417372

<https://www.phoenixcontact.com/in/products/1417372>

## Drawings

Dimensional drawing

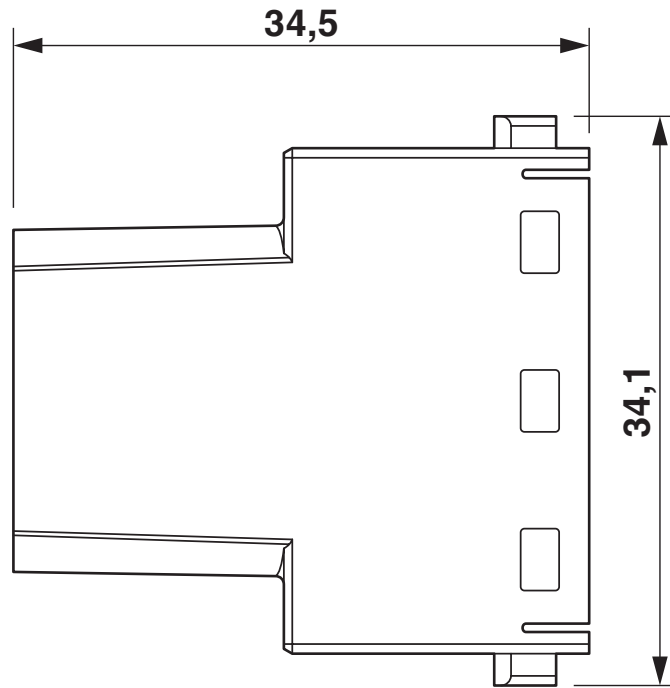
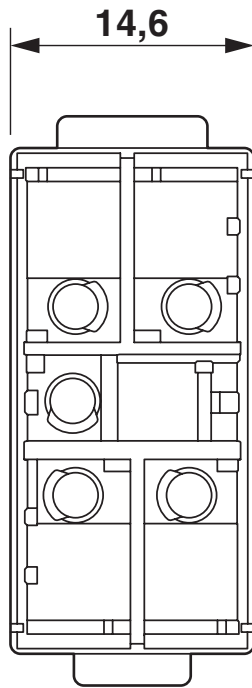

Dimensional drawing

# HC-M-05-PT-M - Contact insert module

1417372

<https://www.phoenixcontact.com/in/products/1417372>

Schematic diagram

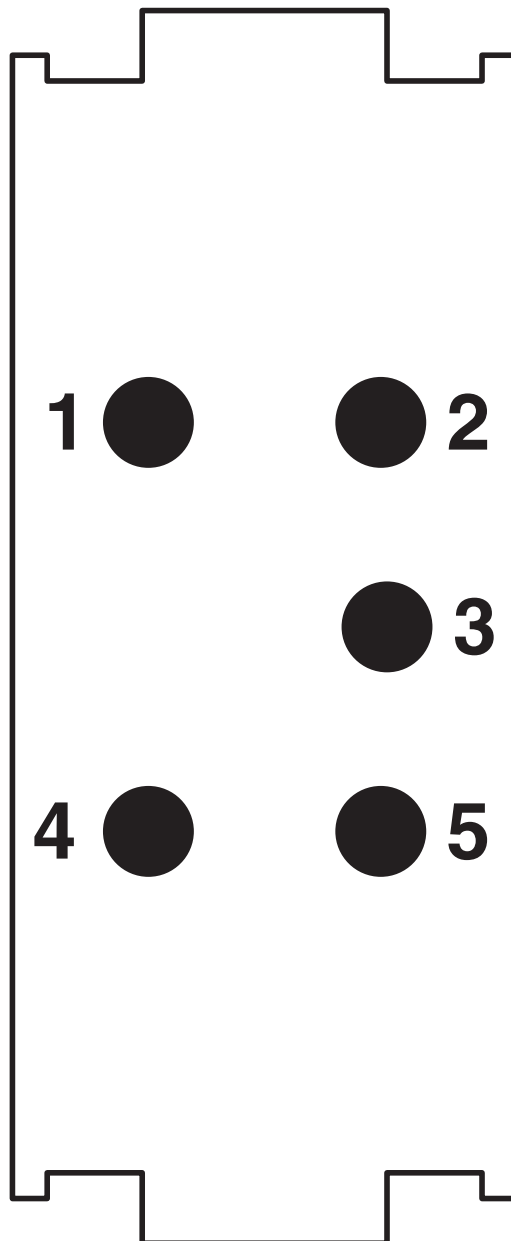

Connector pin assignment, connection side

1417372

<https://www.phoenixcontact.com/in/products/1417372>

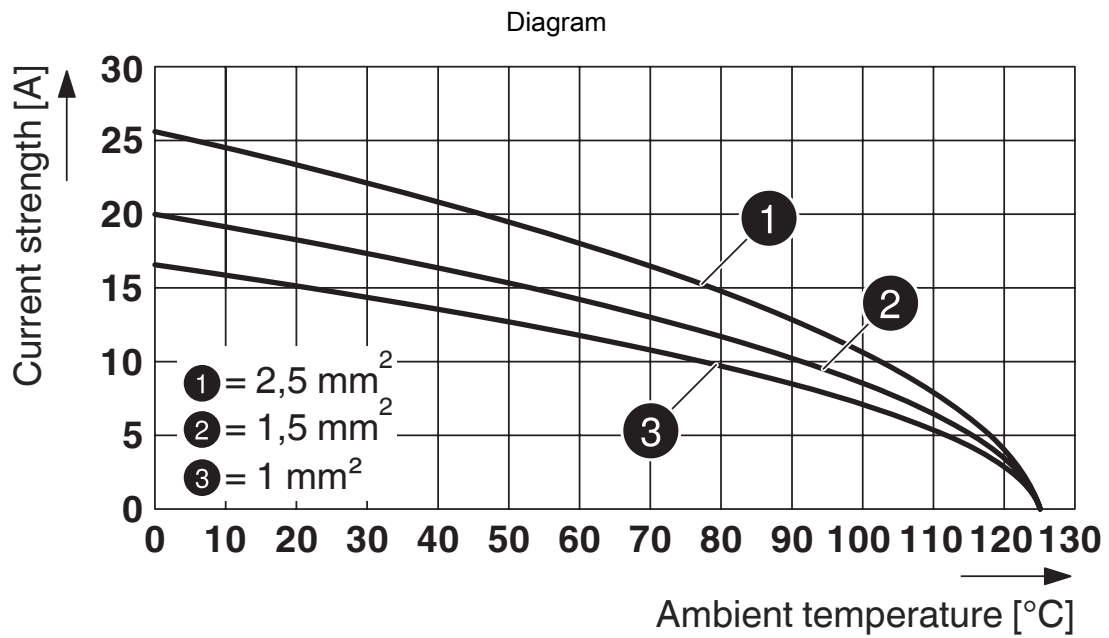

Derating diagram

# HC-M-05-PT-M - Contact insert module



1417372

<https://www.phoenixcontact.com/in/products/1417372>

## Approvals

To download certificates, visit the product detail page: <https://www.phoenixcontact.com/in/products/1417372>

 <b>CSA</b> Approval ID: 13631				
	Nominal voltage $U_N$	Nominal current $I_N$	Cross section AWG	Cross section $\text{mm}^2$
	600 V	15 A	- 14	-

 <b>UL Recognized</b> Approval ID: E118976				
	Nominal voltage $U_N$	Nominal current $I_N$	Cross section AWG	Cross section $\text{mm}^2$
	600 V	19 A	- 14	-

 <b>EAC</b> Approval ID: RU C-DE.BL08.B.00511				
--	--	--	--	--

 <b>UL Recognized</b> Approval ID: E468743				
	Nominal voltage $U_N$	Nominal current $I_N$	Cross section AWG	Cross section $\text{mm}^2$
	600 V	19 A	-	-

# HC-M-05-PT-M - Contact insert module



1417372

<https://www.phoenixcontact.com/in/products/1417372>

## Classifications

### ECLASS

ECLASS-11.0	27440217
ECLASS-12.0	27440217
ECLASS-13.0	27440217

### ETIM

ETIM 9.0	EC000438
----------	----------

### UNSPSC

UNSPSC 21.0	39121400
-------------	----------



# HC-M-05-PT-M - Contact insert module



1417372

<https://www.phoenixcontact.com/in/products/1417372>

## Environmental product compliance

### EU RoHS

Fulfills EU RoHS substance requirements	Yes, No exemptions
---	--------------------

### China RoHS

Environment friendly use period (EFUP)	EFUP-E
	No hazardous substances above the limits

### EU REACH SVHC

REACH candidate substance (CAS No.)	No substance above 0.1 wt%
-------------------------------------	----------------------------

# HC-M-05-PT-M - Contact insert module



1417372

<https://www.phoenixcontact.com/in/products/1417372>

## Accessories

### HC-CBU-MOD - Coding element

1636130

<https://www.phoenixcontact.com/in/products/1636130>



Coding socket for coding up to 16 connectors, for HC Modular

---

### HC-CST-MOD - Coding element

1636127

<https://www.phoenixcontact.com/in/products/1636127>



Coding peg for coding up to 16 connectors, for HC Modular

# HC-M-05-PT-M - Contact insert module

1417372

<https://www.phoenixcontact.com/in/products/1417372>



## HC-M-B06-MFH-B - Module carrier frame

1182085

<https://www.phoenixcontact.com/in/products/1182085>



Module carrier frame, size: B6, type : for the panel mounting side (a, b, c, ...), 4 mm<sup>2</sup> ... 6 mm<sup>2</sup>, application: Module carrier frame

---

## HC-M-B10-MFH-B - Module carrier frame

1182088

<https://www.phoenixcontact.com/in/products/1182088>



Module carrier frame, size: B10, type : for the panel mounting side (a, b, c, ...), 4 mm<sup>2</sup> ... 6 mm<sup>2</sup>, application: Module carrier frame

# HC-M-05-PT-M - Contact insert module

1417372

<https://www.phoenixcontact.com/in/products/1417372>



## HC-M-B16-MFH-B - Module carrier frame

1182090

<https://www.phoenixcontact.com/in/products/1182090>

Module carrier frame, size: B16, type : for the panel mounting side (a, b, c, ...), 4 mm<sup>2</sup> ... 6 mm<sup>2</sup>, application: Module carrier frame



---

## HC-M-B24-MFH-B - Module carrier frame

1182094

<https://www.phoenixcontact.com/in/products/1182094>

Module carrier frame, size: B24, type : for the panel mounting side (a, b, c, ...), 4 mm<sup>2</sup> ... 6 mm<sup>2</sup>, application: Module carrier frame



# HC-M-05-PT-M - Contact insert module

1417372

<https://www.phoenixcontact.com/in/products/1417372>



## HC-M-B06-MFH-H - Module carrier frame

1182087

<https://www.phoenixcontact.com/in/products/1182087>



Module carrier frame, size: B6, type : for the sleeve side (A, B, C, ...), 4 mm<sup>2</sup> ... 6 mm<sup>2</sup>, application: Module carrier frame

---

## HC-M-B10-MFH-H - Module carrier frame

1182089

<https://www.phoenixcontact.com/in/products/1182089>



Module carrier frame, size: B10, type : for the sleeve side (A, B, C, ...), 4 mm<sup>2</sup> ... 6 mm<sup>2</sup>, application: Module carrier frame

# HC-M-05-PT-M - Contact insert module

1417372

<https://www.phoenixcontact.com/in/products/1417372>



## HC-M-B16-MFH-H - Module carrier frame

1182093

<https://www.phoenixcontact.com/in/products/1182093>

Module carrier frame, size: B16, type : for the sleeve side (A, B, C, ...), 4 mm<sup>2</sup> ...  
6 mm<sup>2</sup>, application: Module carrier frame



---

## HC-M-B24-MFH-H - Module carrier frame

1182095

<https://www.phoenixcontact.com/in/products/1182095>

Module carrier frame, size: B24, type : for the sleeve side (A, B, C, ...), 4 mm<sup>2</sup> ...  
6 mm<sup>2</sup>, application: Module carrier frame



## HC-M-05-PT-M - Contact insert module

1417372

<https://www.phoenixcontact.com/in/products/1417372>



## HC-M-05-PT-F - Contact insert module

1417373

<https://www.phoenixcontact.com/in/products/1417373>



Contact insert module, number of positions: 5, power contacts: 5, control contacts: 0, Socket, Push-in connection, 400 V, 16 A, 0.14 mm<sup>2</sup> ... 2.5 mm<sup>2</sup>, application: Power

---

## CF CRIMPHANDY 0,5 - Electrical crimping tool

1212463

<https://www.phoenixcontact.com/in/products/1212463>



Mobile handheld device, battery-powered, for processing on-tape ferrules 0.5 mm<sup>2</sup> with functional end, suitable for PVC insulated conductors (H05V-K), incl. battery, charger, CUTFOX 12 cable cutter, waste guide plate 2, service tool for error correction, and one strip of ferrules 0.5 mm<sup>2</sup>, packed in a robust case.

# HC-M-05-PT-M - Contact insert module

1417372

<https://www.phoenixcontact.com/in/products/1417372>



## CF CRIMPHANDY 0,75 - Electrical crimping tool

1212464

<https://www.phoenixcontact.com/in/products/1212464>



Mobile handheld device, battery-powered, for processing on-tape ferrules 0.75 mm<sup>2</sup> with functional end, suitable for PVC insulated conductors (H05V-K), incl. battery, charger, CUTFOX 12 cable cutter, waste guide plate 2, service tool for error correction, and one strip of ferrules 0.75 mm<sup>2</sup>, packed in a robust case.

---

## CF CRIMPHANDY 1,0 - Electrical crimping tool

1212465

<https://www.phoenixcontact.com/in/products/1212465>



Mobile handheld device, battery-powered, for processing on-tape ferrules 1.0 mm<sup>2</sup> with functional end, suitable for PVC insulated conductors (H05V-K), incl. battery, charger, CUTFOX 12 cable cutter, waste guide plate 2, service tool for error correction, and one strip of ferrules 1.0 mm<sup>2</sup>, packed in a robust case.



# HC-M-05-PT-M - Contact insert module

1417372

<https://www.phoenixcontact.com/in/products/1417372>



## CF CRIMPHANDY 1,5 - Electrical crimping tool

1212466

<https://www.phoenixcontact.com/in/products/1212466>



Mobile handheld device, battery-powered, for processing on-tape ferrules 1.5 mm<sup>2</sup> with functional end, suitable for PVC insulated conductors (H07V-K), incl. battery, charger, CUTFOX 12 cable cutter, waste guide plate 2, service tool for error correction, and one strip of ferrules 1.5 mm<sup>2</sup>, packed in a robust case.

---

## CRIMPFOX 6 - Crimping pliers

1212034

<https://www.phoenixcontact.com/in/products/1212034>



Crimping pliers, for ferrules without insulating collar according to DIN 46228 Part 1 and ferrules with insulating collar according to DIN 46228 Part 4, 0.25 mm<sup>2</sup> ... 6.0 mm<sup>2</sup>, lateral entry, trapezoidal crimp

# HC-M-05-PT-M - Contact insert module



1417372

<https://www.phoenixcontact.com/in/products/1417372>

## CRIMPFOX CENTRUS 10S - Crimping pliers

1213154

<https://www.phoenixcontact.com/in/products/1213154>



Crimping pliers, for uninsulated and insulated ferrules, DIN 46228 Part 1 and 4, from 0.14 mm<sup>2</sup> ... 10 mm<sup>2</sup>, also for TWIN ferrules up to 2 x 4 mm<sup>2</sup>, automatic cross section adjustment, lateral insertion, equipped with fall protection

---

## CRIMPFOX CENTRUS 6S - Crimping pliers

1213144

<https://www.phoenixcontact.com/in/products/1213144>



Crimping pliers, for uninsulated and insulated ferrules, DIN 46228 Part 1 and 4, from 0.14 mm<sup>2</sup> ... 6 mm<sup>2</sup>, also for TWIN ferrules up to 2 x 4 mm<sup>2</sup>, automatic cross section adjustment, lateral insertion, equipped with fall protection

---

Phoenix Contact 2024 © - all rights reserved  
<https://www.phoenixcontact.com>

PHOENIX CONTACT (I) Pvt. Ltd.  
A-58/2, Okhla Industrial Area, Phase - II, New Delhi-110 020

+91.1275.71420  
[info@phoenixcontact.co.in](mailto:info@phoenixcontact.co.in)