

HC-B10-I-PT-F - Contact insert



1407729

<https://www.phoenixcontact.com/in/products/1407729>

Please be informed that the data shown in this PDF document is generated from our Online Catalog. Please find the complete data in the user documentation. Our General Terms of Use for Downloads are valid.

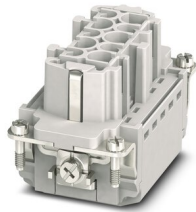

Contact insert, number of positions: 10+PE, size: B10, number of connections per position: 1, Socket, Push-in connection, 500 V, 16 A, 0.14 mm² ... 2.5 mm², application: Power

Your advantages

- Easy installation without tools, even when mounted, with push-in connection technology
- Shortest installation time compared to other connection technologies
- Quick and effortless wiring, in particular when space is tight
- Automatic cabling with robots possible
- Safe wiring and operation with color-coded actuators
- Shock and vibration-resistant in accordance with DIN EN 61373
- Cost-effective and fast coding with plastic profiles
- Test connection for 2 mm test plug

Commercial Data

Item number	1407729
Packing unit	1 pc
Minimum order quantity	1 pc
Sales Key	BF7
Product Key	BF7ABC
Catalog Page	Page 543 (C-2-2019)
GTIN	4046356777544
Weight per Piece (including packing)	63.3 g
Weight per Piece (excluding packing)	63 g
Customs tariff number	85366990
Country of origin	CN

HC-B10-I-PT-F - Contact insert



1407729

<https://www.phoenixcontact.com/in/products/1407729>

Technical Data

Notes

General	only use flexible conductors with ferrules
General	Connectors may be operated only when there is no load/voltage.

Mounting

Assembly instructions	To ensure correct use, installation in housing with IP54 protection or better is required
Connection method	Push-in connection

Product properties

Type	B10
Product type	Contact insert with a fixed no. of positions
Number of positions	10
Connection profile	10+PE
Contact numbering	1 - 10
Application	Power
Number of connections per position	1
Contact type	rolled
Series	HC-B

Insulation characteristics

Overvoltage category	III
Degree of pollution	3

Dimensions

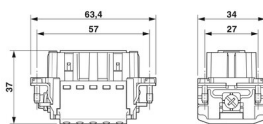
Dimensional drawing	
Width	34 mm
Height	37 mm
Length	64 mm
Drill hole distance, horizontal	57 mm
Drill hole distance, vertical	27 mm

Mechanical characteristics

Contact diameter	2.5 mm
------------------	--------

Connection data

Connection technology

Connection technology	Push-in connection
Number of connections per position	1

HC-B10-I-PT-F - Contact insert



1407729

<https://www.phoenixcontact.com/in/products/1407729>

Connection in acc. with standard	IEC / EN
----------------------------------	----------

Conductor connection

Conductor cross section	0.14 mm ² ... 2.5 mm ²
Connection cross section AWG	26 ... 14
Tightening torque	0.8 Nm ... 1.2 Nm (PE connection)
	0.5 Nm ... 0.8 Nm (Mounting screws for mounting in the HEAVYCON housing)
Stripping length	8 mm ... 10 mm

Electrical properties

Rated voltage (III/3)	500 V
Rated surge voltage	6 kV
Rated current	16 A (power contacts)
SCCR	5 kA (UL 2237)

Mechanical properties

Mechanical data

Insertion/withdrawal cycles	≥ 500
-----------------------------	-------

Material specifications

Flammability rating according to UL 94	V0
Contact material	Copper alloy
Contact surface material	Ag/Sn (tarnish protection)
Contact carrier material	PC
Standards/regulations	PC: Fire protection in rail vehicles - requirement sets R22, R23, and R24 acc. to DIN EN 45545-2 (Risk level HL1 - HL3)

Environmental and real-life conditions

Ambient conditions

Ambient temperature (operation)	-40 °C ... 125 °C (including heating up of contacts)
---------------------------------	--

Standards and regulations

Testing

Standards/regulations	PC: Fire protection in rail vehicles - requirement sets R22, R23, and R24 acc. to DIN EN 45545-2 (Risk level HL1 - HL3)
-----------------------	---

HC-B10-I-PT-F - Contact insert

1407729

<https://www.phoenixcontact.com/in/products/1407729>



Drawings

Schematic diagram

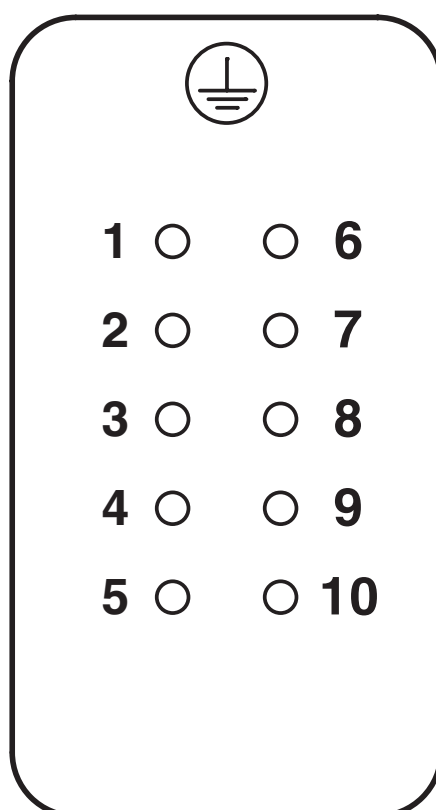

Connector pin assignment, connection side

HC-B10-I-PT-F - Contact insert

1407729

<https://www.phoenixcontact.com/in/products/1407729>

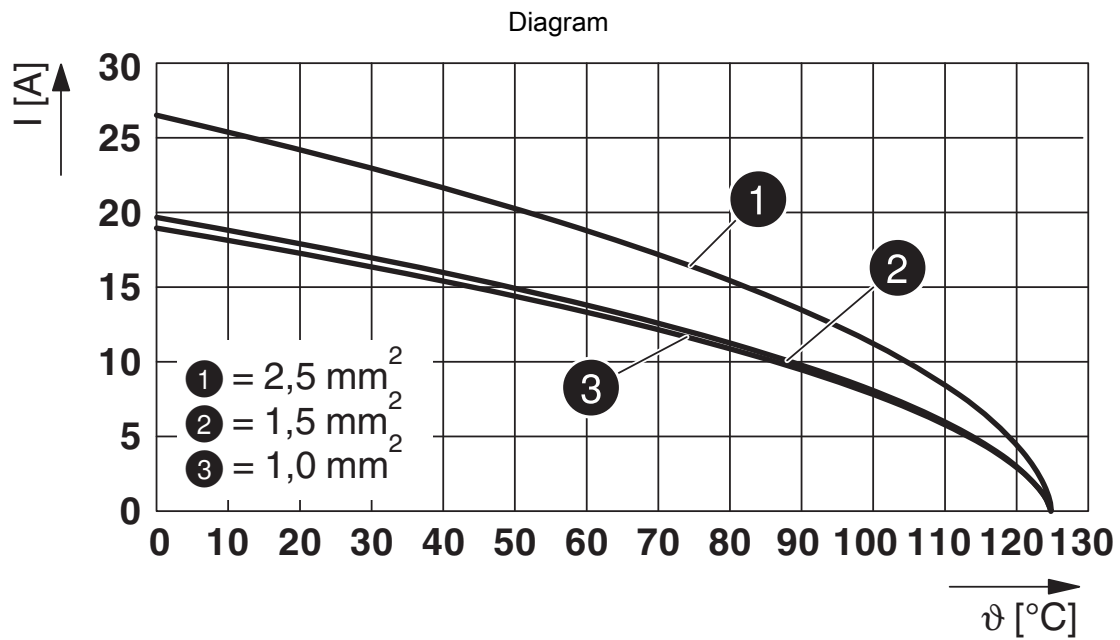

Derating diagram

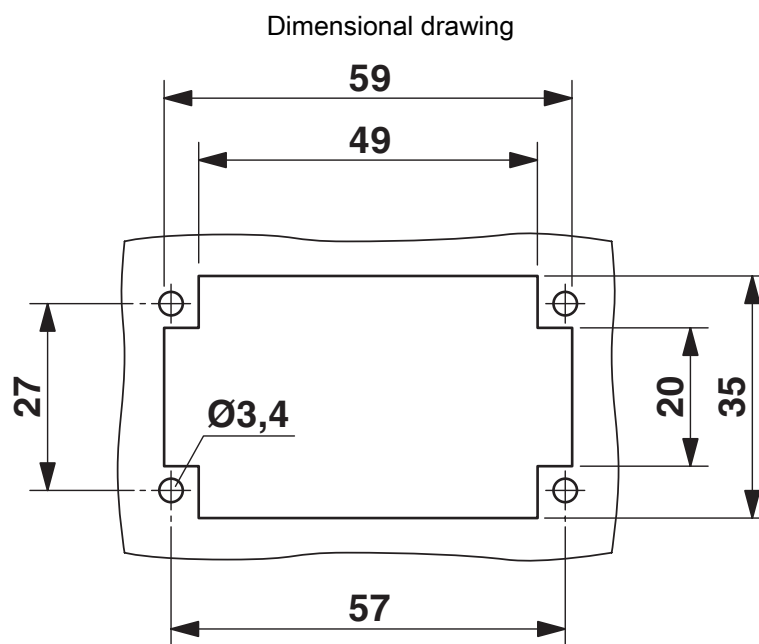

Mounting cutout when used without housing

HC-B10-I-PT-F - Contact insert

1407729

<https://www.phoenixcontact.com/in/products/1407729>



Dimensional drawing

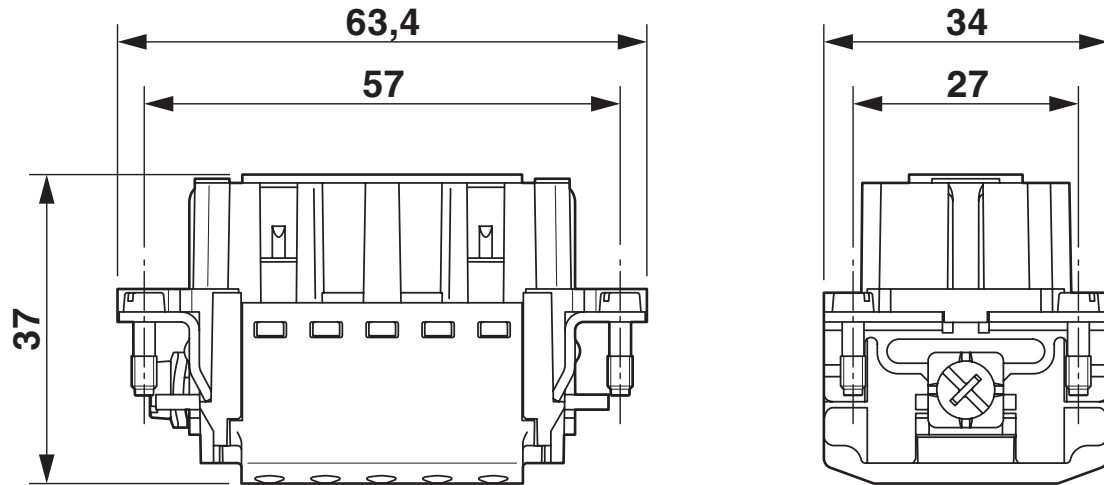

Dimensional drawing

HC-B10-I-PT-F - Contact insert



1407729

<https://www.phoenixcontact.com/in/products/1407729>

Approvals

 CSA Approval ID: 13631	Nominal Voltage U_N	Nominal Current I_N	Cross Section AWG	Cross Section mm^2
	600 V	10 A	- 14	-

 UL Recognized Approval ID: FILE E 118976	Nominal Voltage U_N	Nominal Current I_N	Cross Section AWG	Cross Section mm^2
	600 V	13 A	- 14	-

 EAC Approval ID: RU C-DE.AI30.B.01102

 cULus Recognized Approval ID: E468743	Nominal Voltage U_N	Nominal Current I_N	Cross Section AWG	Cross Section mm^2
	600 V	13 A	- 14	-

 EAC Approval ID: RU C-DE.BL08.B.00511

HC-B10-I-PT-F - Contact insert



1407729

<https://www.phoenixcontact.com/in/products/1407729>

Classifications

ECLASS

ECLASS-11.0	27440205
ECLASS-12.0	27440205
ECLASS-13.0	27440205

ETIM

ETIM 8.0	EC000438
----------	----------

UNSPSC

UNSPSC 21.0	39121500
-------------	----------

HC-B10-I-PT-F - Contact insert



1407729

<https://www.phoenixcontact.com/in/products/1407729>

Environmental Product Compliance

China RoHS	Environmentally friendly use period: unlimited = EFUP-e No hazardous substances above threshold values
------------	---

HC-B10-I-PT-F - Contact insert

1407729

<https://www.phoenixcontact.com/in/products/1407729>



Accessories

CP-HC - Coding profile

1686478

<https://www.phoenixcontact.com/in/products/1686478>

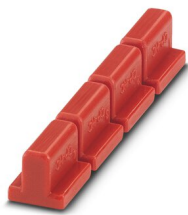

Coding profile, 4 coding profiles per strip, for insertion in coding keyways

HC-CB - Coding bolt

1772722

<https://www.phoenixcontact.com/in/products/1772722>



Coding pin, prevents mismatching of up to six connectors with an identical number of positions

HC-B10-I-PT-F - Contact insert

1407729

<https://www.phoenixcontact.com/in/products/1407729>



HC-CST - Coding element

1676857

<https://www.phoenixcontact.com/in/products/1676857>



Coding peg for coding up to 16 connectors

HC-CBU - Coding element

1676860

<https://www.phoenixcontact.com/in/products/1676860>



Coding socket for coding up to 16 connectors

HC-B10-I-PT-F - Contact insert

1407729

<https://www.phoenixcontact.com/in/products/1407729>



HC-B-PE-PT - Adapter

1054672

<https://www.phoenixcontact.com/in/products/1054672>



PE adapter with PT connection, for 1 PE connection, for HC-B / HC-BB / HC-DD / HC-D40 / HC-D64 contact inserts

HC-B-2PE-PT - PE multiplier

1054675

<https://www.phoenixcontact.com/in/products/1054675>

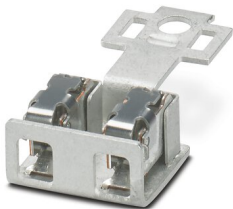

PE adapter with PT connection, for 2 PE connections, for HC-B / HC-BB / HC-DD / HC-D40 / HC-D64 contact inserts

HC-B10-I-PT-F - Contact insert

1407729

<https://www.phoenixcontact.com/in/products/1407729>



HC-B-3PE - PE multiplier

1644326

<https://www.phoenixcontact.com/in/products/1644326>



PE multiplier, for 3 PE connections, for HC-B / HC-BB / HC-DD / HC-D40 / HC-D64 contact inserts

HC-B-PES - Screw

1604997

<https://www.phoenixcontact.com/in/products/1604997>



PE screw, for contact inserts HC-B / HC-BB / HC-DD / HC-D40 / HC-D64

HC-B10-I-PT-F - Contact insert

1407729

<https://www.phoenixcontact.com/in/products/1407729>



HC-B-ZG - Strain relief clamp

1685327

<https://www.phoenixcontact.com/in/products/1685327>



Strain relief clamps contact inserts of series: B-, BB-, D 40, D 64, DD and HV, straight cable exit

HC-B-ZS - Strain relief clamp

1685330

<https://www.phoenixcontact.com/in/products/1685330>



Strain relief clamps contact inserts of series: B-, BB-, D 40, D 64, DD and HV, lateral cable exit

HC-B10-I-PT-F - Contact insert

1407729

<https://www.phoenixcontact.com/in/products/1407729>



HC-CIF-B10-HFWL-PL - DIN rail mounting frame

1424335

<https://www.phoenixcontact.com/in/products/1424335>



DIN rail mounting frame, design: B10, for contact inserts, Top frame

HC-B 10-ANDOCK - Docking frame

1586125

<https://www.phoenixcontact.com/in/products/1586125>



Docking frame for racks, for contact inserts of B10 type, with four M5 flat headed screws, rack balance x/y axis ± 1.5 mm

HC-B10-I-PT-F - Contact insert

1407729

<https://www.phoenixcontact.com/in/products/1407729>



HC-CIF-B06-24-BFAFL-PL - DIN rail mounting frame

1424338

<https://www.phoenixcontact.com/in/products/1424338>



DIN rail mounting frame, design: B6 - B24, for contact inserts, Base frame

HC-B24/10-ADP-SS - Adapter plate

1034213

<https://www.phoenixcontact.com/in/products/1034213>



Adapter plate, design: B24 to B10

HC-B10-I-PT-F - Contact insert

1407729

<https://www.phoenixcontact.com/in/products/1407729>



CRIMPFOX CENTRUS 6S - Crimping pliers

1213144

<https://www.phoenixcontact.com/in/products/1213144>



Crimping pliers, for uninsulated and insulated ferrules, DIN 46228 Part 1 and 4, from 0.14 mm² ... 6 mm², also for TWIN ferrules up to 2 x 4 mm², automatic cross section adjustment, lateral insertion, equipped with fall protection

CRIMPFOX 6 - Crimping pliers

1212034

<https://www.phoenixcontact.com/in/products/1212034>



Crimping pliers, for ferrules without insulating collar according to DIN 46228 Part 1 and ferrules with insulating collar according to DIN 46228 Part 4, 0.25 mm² ... 6.0 mm², lateral entry, trapezoidal crimp

HC-B10-I-PT-F - Contact insert

1407729

<https://www.phoenixcontact.com/in/products/1407729>



CF CRIMPHANDY 0,5 - Electrical crimping tool

1212463

<https://www.phoenixcontact.com/in/products/1212463>



Mobile handheld device, battery-powered, for processing on-tape ferrules 0.5 mm² with functional end, suitable for PVC insulated conductors (H05V-K), incl. battery, charger, CUTFOX 12 cable cutter, waste guide plate 2, service tool for error correction, and one strip of ferrules 0.5 mm², packed in a robust case.

CF CRIMPHANDY 0,75 - Electrical crimping tool

1212464

<https://www.phoenixcontact.com/in/products/1212464>



Mobile handheld device, battery-powered, for processing on-tape ferrules 0.75 mm² with functional end, suitable for PVC insulated conductors (H05V-K), incl. battery, charger, CUTFOX 12 cable cutter, waste guide plate 2, service tool for error correction, and one strip of ferrules 0.75 mm², packed in a robust case.

HC-B10-I-PT-F - Contact insert

1407729

<https://www.phoenixcontact.com/in/products/1407729>



CF CRIMPHANDY 1,0 - Electrical crimping tool

1212465

<https://www.phoenixcontact.com/in/products/1212465>



Mobile handheld device, battery-powered, for processing on-tape ferrules 1.0 mm² with functional end, suitable for PVC insulated conductors (H05V-K), incl. battery, charger, CUTFOX 12 cable cutter, waste guide plate 2, service tool for error correction, and one strip of ferrules 1.0 mm², packed in a robust case.

CF CRIMPHANDY 1,5 - Electrical crimping tool

1212466

<https://www.phoenixcontact.com/in/products/1212466>



Mobile handheld device, battery-powered, for processing on-tape ferrules 1.5 mm² with functional end, suitable for PVC insulated conductors (H07V-K), incl. battery, charger, CUTFOX 12 cable cutter, waste guide plate 2, service tool for error correction, and one strip of ferrules 1.5 mm², packed in a robust case.

HC-B10-I-PT-F - Contact insert

1407729

<https://www.phoenixcontact.com/in/products/1407729>



HC-B10-I-PT-M - Contact insert

1407730

<https://www.phoenixcontact.com/in/products/1407730>

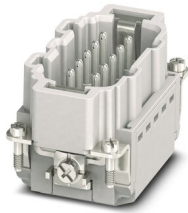

Contact insert, number of positions: 10+PE, size: B10, number of connections per position: 1, Pin, Push-in connection, 500 V, 16 A, 0.14 mm² ... 2.5 mm², application: Power

Phoenix Contact 2023 © - all rights reserved

<https://www.phoenixcontact.com>

PHOENIX CONTACT (I) Pvt. Ltd.

A-58/2, Okhla Industrial Area, Phase - II, New Delhi-110 020

+91.1275.71420

info@phoenixcontact.co.in