

CES-STPG-GY-6 - Cable sleeve



0801676

<https://www.phoenixcontact.com/in/products/0801676>

Please be informed that the data shown in this PDF document is generated from our online catalog. Please find the complete data in the user documentation. Our general terms of use for downloads are valid.

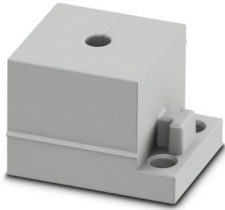

Cable sleeve, small, no. of conductors: 1, type: Round cable, slotted, external cable diameter: 1x 5 mm ... 6 mm, material: SEBS (halogen-free), color: gray, length: 29.5 mm, width: 19.5 mm, height: 17 mm

Product description

Slotted cable sleeve

Commercial data

Item number	0801676
Packing unit	10 pc
Minimum order quantity	10 pc
Sales key	BF7
Product key	BF7CCX
Catalog page	Page 680 (C-2-2019)
GTIN	4046356674829
Weight per piece (including packing)	7.84 g
Weight per piece (excluding packing)	7.84 g
Customs tariff number	40169997
Country of origin	PL

CES-STPG-GY-6 - Cable sleeve

0801676

<https://www.phoenixcontact.com/in/products/0801676>

Technical data

Product properties

Product type	Cable sleeve
No. of conductors	1

Dimensions

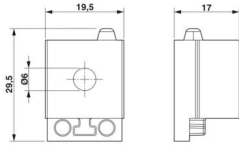
Dimensional drawing	
Width	19.5 mm
Height	17 mm
Length	29.5 mm

Material specifications

Material	SEBS
Flammability rating according to UL 94	V0

Cable/line

External cable diameter	1x 5 mm ... 6 mm
-------------------------	------------------

Characteristics

Seal size	small
Design, Format	Round cable
Design, Cable seal	slotted

Environmental and real-life conditions

Ambient conditions

Degree of protection	IP54
Ambient temperature (operation)	-40 °C ... 80 °C (static)

CES-STPG-GY-6 - Cable sleeve

0801676

<https://www.phoenixcontact.com/in/products/0801676>



Drawings

Dimensional drawing

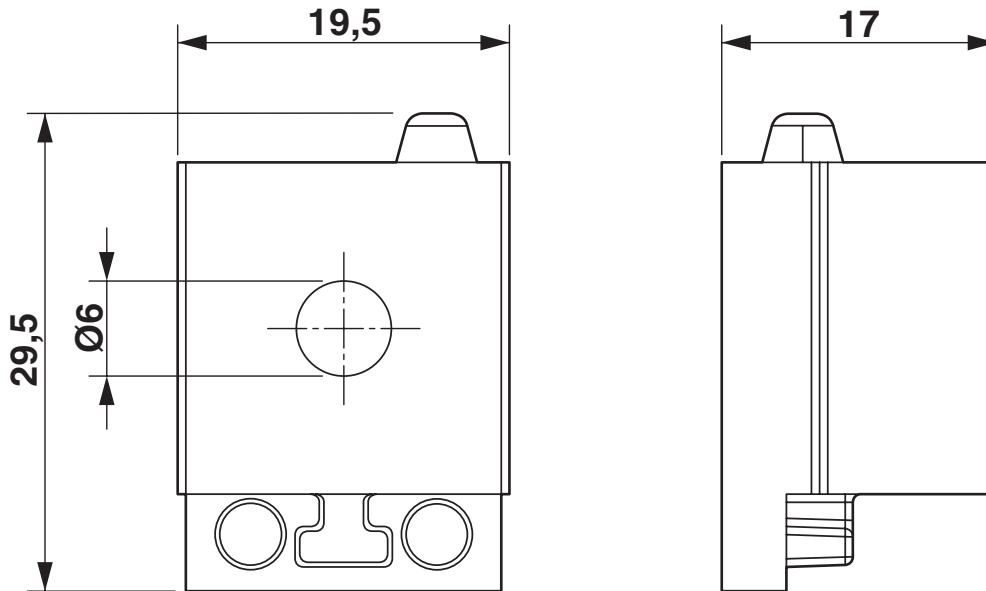

Dimensional drawing

CES-STPG-GY-6 - Cable sleeve



0801676

<https://www.phoenixcontact.com/in/products/0801676>

Approvals

To download certificates, visit the product detail page: <https://www.phoenixcontact.com/in/products/0801676>



cUL Recognized

Approval ID: NITW8.E255026



UL Recognized

Approval ID: NITW2.E255026

DNV

Approval ID: TAE00003VJ

cULus Recognized

CES-STPG-GY-6 - Cable sleeve



0801676

<https://www.phoenixcontact.com/in/products/0801676>

Classifications

ECLASS

ECLASS-11.0	27144425
ECLASS-12.0	27144425
ECLASS-13.0	27144425

ETIM

ETIM 9.0	EC000451
----------	----------

UNSPSC

UNSPSC 21.0	39121400
-------------	----------

CES-STPG-GY-6 - Cable sleeve



0801676

<https://www.phoenixcontact.com/in/products/0801676>

Environmental product compliance

EU RoHS

Fulfills EU RoHS substance requirements	Yes, No exemptions
---	--------------------

China RoHS

Environment friendly use period (EFUP)	EFUP-E
	No hazardous substances above the limits

EU REACH SVHC

REACH candidate substance (CAS No.)	No substance above 0.1 wt%
-------------------------------------	----------------------------

CES-STPG-GY-6 - Cable sleeve

0801676

<https://www.phoenixcontact.com/in/products/0801676>



Accessories

KDT-ST 6 - Filler plug

3063950

<https://www.phoenixcontact.com/in/products/3063950>



Filler plug, material: PA, length: 25 mm, diameter: 6 mm

CES-B10-HFFS-PLBK - Sealing frame

0801663

<https://www.phoenixcontact.com/in/products/0801663>



Sealing frame, With locking latch, design: B10, Number of cable seals (small): 6, material: PA (halogen-free), color: black, length: 99.2 mm, width: 58 mm, height: 20 mm

CES-STPG-GY-6 - Cable sleeve

0801676

<https://www.phoenixcontact.com/in/products/0801676>



CES-B16-HFFS-PLBK - Sealing frame

0801662

<https://www.phoenixcontact.com/in/products/0801662>



Sealing frame, With locking latch, design: B16, Number of cable seals (small): 8, material: PA (halogen-free), color: black, length: 120 mm, width: 58 mm, height: 20 mm

CES-B24-HFFS-PLBK - Sealing frame

0801661

<https://www.phoenixcontact.com/in/products/0801661>



Sealing frame, With locking latch, design: B24, Number of cable seals (small): 10, material: PA (halogen-free), color: black, length: 147 mm, width: 58 mm, height: 20 mm

CES-STPG-GY-6 - Cable sleeve

0801676

<https://www.phoenixcontact.com/in/products/0801676>



CES-B10-SFFS-PLBK - Sealing frame

0801660

<https://www.phoenixcontact.com/in/products/0801660>



Sealing frame, with screw locking, design: B10, Number of cable seals (small): 6, material: PA (halogen-free), color: black, length: 99.2 mm, width: 58 mm, height: 20 mm

CES-B16-SFFS-PLBK - Sealing frame

0801659

<https://www.phoenixcontact.com/in/products/0801659>



Sealing frame, with screw locking, design: B16, Number of cable seals (small): 8, material: PA (halogen-free), color: black, length: 120 mm, width: 58 mm, height: 20 mm

CES-STPG-GY-6 - Cable sleeve

0801676

<https://www.phoenixcontact.com/in/products/0801676>



CES-B24-SFFS-PLBK - Sealing frame

0801658

<https://www.phoenixcontact.com/in/products/0801658>



Sealing frame, with screw locking, design: B24, Number of cable seals (small): 10, material: PA (halogen-free), color: black, length: 147 mm, width: 58 mm, height: 20 mm

Phoenix Contact 2024 © - all rights reserved

<https://www.phoenixcontact.com>

PHOENIX CONTACT (I) Pvt. Ltd.

A-58/2, Okhla Industrial Area, Phase - II, New Delhi-110 020

+91.1275.71420

info@phoenixcontact.co.in