

CES-LRG-BK-24 - Cable sleeve



0801639

<https://www.phoenixcontact.com/in/products/0801639>

Please be informed that the data shown in this PDF document is generated from our Online Catalog. Please find the complete data in the user documentation. Our General Terms of Use for Downloads are valid.

Cable sleeve, large, no. of conductors: 1, type: Round cable, slotted, external cable diameter: 1x 23 mm ... 24 mm, material: NBR, color: black, length: 53 mm, width: 39 mm, height: 17 mm



Product Description

Slotted cable sleeve Slotted sleeves for accommodating pre-assembled cables and lines with a diameter of 23 mm ... 24 mm, can be used in CES sealing frames.

Commercial Data

Item number	0801639
Packing unit	10 pc
Minimum order quantity	10 pc
Sales Key	BF7
Product Key	BF7CCX
Catalog Page	Page 678 (C-2-2019)
GTIN	4046356674348
Weight per Piece (including packing)	28.44 g
Weight per Piece (excluding packing)	28.44 g
Customs tariff number	40169997
Country of origin	TW

CES-LRG-BK-24 - Cable sleeve

0801639

<https://www.phoenixcontact.com/in/products/0801639>

Technical Data

Product properties

Product type	Cable sleeve
No. of conductors	1

Dimensions

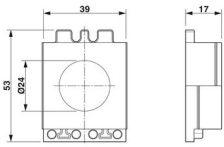
Dimensional drawing	
Width	39 mm
Height	17 mm
Length	53 mm

Material specifications

Color	black
Material	NBR

Cable/line

External cable diameter	1x 23 mm ... 24 mm
-------------------------	--------------------

Characteristics

Seal size	large
Design, Format	Round cable
Design, Cable seal	slotted

Environmental and real-life conditions

Ambient conditions

Degree of protection	IP54
Ambient temperature (operation)	-40 °C ... 125 °C (static)

CES-LRG-BK-24 - Cable sleeve

0801639

<https://www.phoenixcontact.com/in/products/0801639>

Drawings

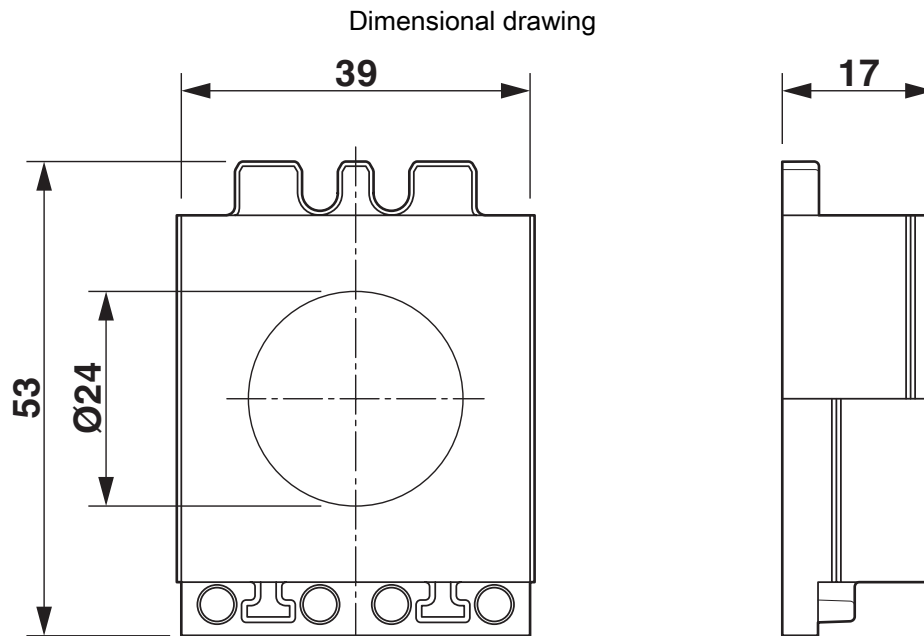

Dimensional drawing

CES-LRG-BK-24 - Cable sleeve



0801639

<https://www.phoenixcontact.com/in/products/0801639>

Classifications

ECLASS

ECLASS-11.0	27144425
ECLASS-12.0	27144425
ECLASS-13.0	27144425

ETIM

ETIM 8.0	EC000451
----------	----------

UNSPSC

UNSPSC 21.0	39121400
-------------	----------

CES-LRG-BK-24 - Cable sleeve



0801639

<https://www.phoenixcontact.com/in/products/0801639>

Environmental Product Compliance

China RoHS	Environmentally friendly use period: unlimited = EFUP-e
	No hazardous substances above threshold values

CES-LRG-BK-24 - Cable sleeve

0801639

<https://www.phoenixcontact.com/in/products/0801639>



Accessories

CES-B10-HFFS-PLBK - Sealing frame

0801663

<https://www.phoenixcontact.com/in/products/0801663>



Sealing frame with locking latch, size B10, with flat gasket, for 6 small sleeves

CES-B16-HFFS-PLBK - Sealing frame

0801662

<https://www.phoenixcontact.com/in/products/0801662>



Sealing frame with locking latch, size B16, with flat gasket, for 8 small sleeves

CES-LRG-BK-24 - Cable sleeve

0801639

<https://www.phoenixcontact.com/in/products/0801639>



CES-B24-HFFS-PLBK - Sealing frame

0801661

<https://www.phoenixcontact.com/in/products/0801661>



Sealing frame with locking latch, size B24, with flat gasket, for 10 small sleeves

CES-B10-SFFS-PLBK - Sealing frame

0801660

<https://www.phoenixcontact.com/in/products/0801660>



Sealing frame with screw locking, size B10, with flat gasket, for 6 small sleeves

CES-LRG-BK-24 - Cable sleeve

0801639

<https://www.phoenixcontact.com/in/products/0801639>



CES-B16-SFFS-PLBK - Sealing frame

0801659

<https://www.phoenixcontact.com/in/products/0801659>



Sealing frame with screw locking, size B16, with flat gasket, for 8 small sleeves

CES-B24-SFFS-PLBK - Sealing frame

0801658

<https://www.phoenixcontact.com/in/products/0801658>



Sealing frame with screw locking, size B24, with flat gasket, for 10 small sleeves

Phoenix Contact 2023 © - all rights reserved
<https://www.phoenixcontact.com>

PHOENIX CONTACT (I) Pvt. Ltd.
A-58/2, Okhla Industrial Area, Phase - II, New Delhi-110 020

+91.1275.71420
info@phoenixcontact.co.in