

Universal Relays

RU Series



Full featured universal miniature relays. Designed with environment taken into consideration.



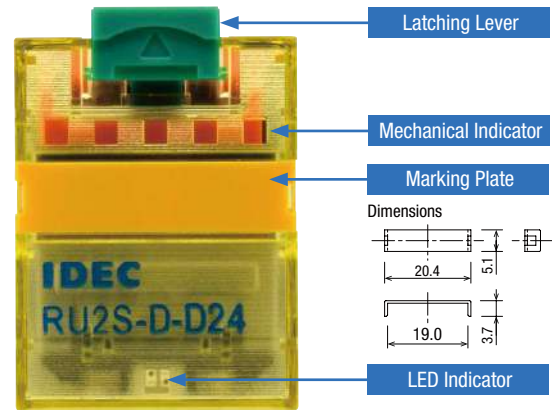
- See website for details on approvals and standards.
- Lloyd Register type approved.

Safety

The contact position can be confirmed through the five small windows.

Using the latching lever, operation can be checked without energizing the coil. The latching lever is color coded for AC and DC coils. (AC coil: Orange DC coil: Green)

Non-polarized LED indicator available on plug-in relays.



Reliable

No internal wires. Simple construction.

Easy-to-Use

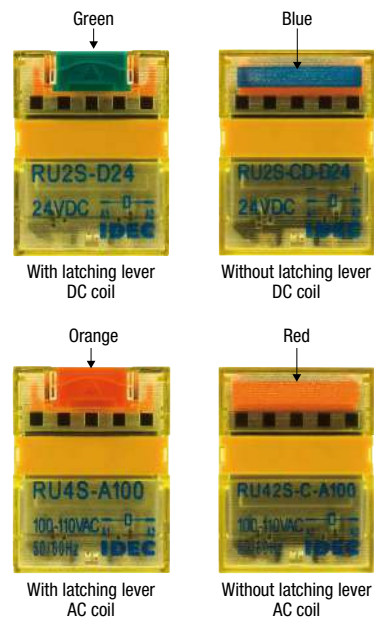
Marking plate for easy identification of relays

(Optional marking plates available in four other colors)

Applicable for small loads to maximum contact currents. (See table below)



| | RU2 | RU4 | RU42 |
|-----------------------------|---------------|--------------|----------------|
| Max. continuous current | 10A | 6A | 3A |
| Min. applicable load (Note) | 24V DC 5mA | 1V DC 1mA | 1V DC 0.1mA |

Note: Reference value.




RU Series Universal Relays

Single Contact

| shape | | |  Plug-in Terminal With Latching Lever Standard (DPDT) | |  PCB Terminal Without Latching Lever Standard (4PDT) | |
|-----------------------|------------------------|--|---|------------|--|--|
| Termination | Latching Lever | Style | Part No. | | Coil Voltage Code * | |
| | | | DPDT | 4PDT | | |
| Plug-in Terminal (*1) | With Latching Lever | Standard | RU2S-* | RU4S-* | A24, A100, A110, A200, A220 D6, D12, D24, D48, D100, D110 | |
| | | With RC (AC coil only) | RU2S-R-* | RU4S-R-* | A100, A110, A200, A220 | |
| | | With diode (DC coil only) | RU2S-D-* | RU4S-D-* | D6, D12, D24, D48, D110 | |
| | | With diode (DC coil only) Reverse polarity coil | RU2S-D1-* | RU4S-D1* | D24 | |
| | Without Latching Lever | Standard | RU2S-C-* | RU4S-C-* | A24, A100, A110, A200, A220 D6, D12, D24, D48, D100, D110 | |
| | | With RC (AC coil only) | RU2S-CR-* | RU4S-CR-* | A100, A110, A200, A220 | |
| | | With diode (DC coil only) | RU2S-CD-* | RU4S-CD-* | D6, D12, D24, D48, D110 | |
| | | With diode (DC coil only) Reverse polarity coil | RU2S-CD1-* | RU4S-CD1-* | D24 | |
| PCB Terminal | Without Latching Lever | Simple (*2) | RU2V-NF-* | RU4V-NF-* | A24, A100, A110, A200, A220 D6, D12, D24, D48, D100, D110 | |

Bifurcated Contact

| shape | | |  Plug-in Terminal With Latching Lever Standard | |
|-----------------------|------------------------|--|--|--|
| Termination | Latching Lever | Style | Part No. 4PDT | Coil Voltage Code * |
| Plug-in Terminal (*1) | With Latching Lever | Standard | RU42S-* | A24, A100, A110, A200, A220 D6, D12, D24, D48, D100, D110 |
| | | With RC (AC coil only) | RU42S-R-* | A100, A110, A200, A220 |
| | | With diode (DC coil only) | RU42S-D-* | D6, D12, D24, D48, D100, D110 |
| | | With diode (DC coil only) Reverse polarity coil | RU42S-D1-* | D24 |
| | Without Latching Lever | Standard | RU42S-C-* | A24, A100, A110, A200, A220 D6, D12, D24, D48, D100, D110 |
| | | With RC (AC coil only) | RU42S-CR-* | A100, A110, A200, A220 |
| | | With diode (DC coil only) | RU42S-CD-* | D6, D12, D24, D48, D100, D110 |
| | | With diode (DC coil only) Reverse polarity coil | RU42S-CD1-* | D24 |
| PCB Terminal | Without Latching Lever | Simple (*2) | RU42V-NF-* | A24, A100, A110, A200, A220 D6, D12, D24, D48, D100, D110 |

*1) Plug-in terminal, except for simple types, have an LED indicator and a mechanical indicator as standard.

*2) Simple types do not have an LED indicator, a mechanical indicator, and a latching lever.

Accessory

| Name | Part No. | Ordering No. | Color Code * | Package Quantity |
|---------------|----------|--------------|--|------------------|
| Marking Plate | RU9Z-P* | RU9Z-P*PN10 | A (orange), G (green), S (blue), W (white), Y (yellow) | 10 |

Note: Specify a color code in place of the Part No. When ordering, specify the Ordering No.
The marking plate can be removed from the relay by inserting a flat screwdriver under the marking plate.

Part No. Development

Specify a coil voltage code in place of * in the Part No.

| Coil Voltage Code * | Coil Rating |
|---------------------|--------------------------------|
| 24V AC | White |
| 100-110V AC | Clear |
| 110-120V AC | Blue |
| 200-220V AC | Black |
| 220-240V AC | Red |
| 24V DC | Green |
| 6V DC | Voltage marking on yellow tape |
| 12V DC | |
| 48V DC | |
| 100V DC | |
| 110V DC | |

- APEM
- Switches & Pilot Lights
- Control Boxes
- Emergency Stop Switches
- Enabling Switches
- Safety Products
- Explosion Proof
- Terminal Blocks
- Relays & Sockets
- Circuit Protectors
- Power Supplies
- LED Illumination
- Controllers
- Operator Interfaces
- Sensors

- AUTO-ID

- Relays

- Sockets
- DIN Rail Products

- RJ

- RU

- RV8H

- RL

RU Series Universal Relays

Coil Ratings

| Rated Voltage (V) | Coil Voltage Code | Rated Current (mA) ±15% (at 20°C) | | Coil Resistance (Ω) ±10% (at 20°C) | Operating Characteristics (against rated values at 20°C) | | | |
|-------------------|-------------------|-----------------------------------|----------|------------------------------------|--|------------------------|-----------------|--------|
| | | 50 Hz | 60 Hz | | Maximum Continuous Applied Voltage | Minimum Pickup Voltage | Dropout Voltage | |
| AC (50/60 Hz) | 24 | A24 | 49.3 | 42.5 | 110% | 80% maximum | 30% minimum | |
| | 100-110 | A100 | 9.2-11.0 | 7.8-9.0 | | | | 164 |
| | 110-120 | A110 | 8.4-10.0 | 7.1-8.2 | | | | 3,460 |
| | 200-220 | A200 | 4.6-5.5 | 4.0-4.6 | | | | 4,550 |
| | 220-240 | A220 | 4.2-5.0 | 3.6-4.2 | 14,080 | | | |
| DC | 6 | D6 | 155 | | 110% | 80% maximum | 10% minimum | |
| | 12 | D12 | 80 | | | | | 40 |
| | 24 | D24 | 44.7 | | | | | 160 |
| | 48 | D48 | 18 | | | | | 605 |
| | 100 | D100 | 9.7 | | | | | 2,560 |
| | 110 | D110 | 8.9 | | | | | 10,000 |
| | | | 12,100 | | | | | |

• The rated current includes the current draw by the LED indicator.

Contact Ratings

| Contact | Continuous Current | Allowable Contact Power | | Voltage (V) | Rated Load | | |
|------------------------|--------------------|-------------------------|----------------------|-------------|------------|-----------|------------------------------|
| | | Resistive Load | Inductive Load | | Res. Load | Ind. Load | Electrical Life (operations) |
| DPDT (RU2) | 10A | 2500VA AC 300W DC | 1250VA AC 150W DC | 250 AC | 10A | 5A | 100,000 min. |
| | | | | | 5A | — | 500,000 min. |
| | | | | | — | 2.5A | 300,000 min. |
| | | | | 30 DC | 10A | 5A | 100,000 min. |
| | | | | | 5A | — | 500,000 min. |
| | | | | | — | 2.5A | 300,000 min. |
| 110 DC | 0.6A | 0.4A | 100,000 min. | | | | |
| | 6A | 2.6A | 50,000 min. | | | | |
| | 3A | 0.8A | 200,000 min. | | | | |
| 4PDT (RU4) | 6A | 1500VA AC 180W DC | 600VA AC 90W DC | 250 AC | 6A | 2.7A | 50,000 min. |
| | | | | | 3A | 1.5A | 200,000 min. |
| | | | | 30 DC | 0.65A | 0.33A | 50,000 min. |
| | | | | | 0.33A | 0.18A | 200,000 min. |
| | | | | 110 DC | 3A | 0.8A | 100,000 min. |
| | | | | | 3A | 1.5A | 100,000 min. |
| 0.44A | 0.22A | 100,000 min. | | | | | |
| 4PDT (RU42) bifurcated | 3A | 750VA AC 90W DC | 200VA AC 45W DC | 250 AC | 3A | 0.8A | 100,000 min. |
| | | | | 30 DC | 3A | 1.5A | 100,000 min. |
| | | | | 110 DC | 0.44A | 0.22A | 100,000 min. |

• On 4PDT relays, the maximum allowable total current of neighboring two poles is 6A. At the rated load, make sure that the total current of neighboring two poles does not exceed 6A (3A + 3A = 6A).

UL and c-UL Ratings

| Voltage | Resistive | | | General Use | | | Horse Power Rating | | |
|---------|-----------|-----|------|-------------|-----|------|--------------------|--------|------|
| | RU2 | RU4 | RU42 | RU2 | RU4 | RU42 | RU2 | RU4 | RU42 |
| 250V AC | 10A | — | — | — | 6A | 3A | — | 1/10HP | — |
| 30V DC | 10A | 6A | 3A | — | — | — | — | — | — |

CSA Ratings

| Voltage | Resistive | | | General Use | | | Horse Power Rating | | |
|---------|-----------|-----|------|-------------|-----|------|--------------------|--------|------|
| | RU2 | RU4 | RU42 | RU2 | RU4 | RU42 | RU2 | RU4 | RU42 |
| 250V AC | 10A | — | — | — | 6A | 3A | — | 1/10HP | — |
| 30V DC | 10A | 6A | 3A | — | — | — | — | — | — |

TÜV Ratings

| Voltage | Resistive | | | Inductive | | |
|---------|-----------|-----|------|-----------|------|------|
| | RU2 | RU4 | RU42 | RU2 | RU4 | RU42 |
| 250V AC | 10A | 6A | 3A | 5A | 0.8A | 0.8A |
| 30V DC | 10A | 6A | 3A | 5A | 1.5A | 1.5A |

Surge Suppressor Ratings

| Type | Ratings | |
|---------|------------|---|
| AC Coil | With RC | RC series circuit R: 20 kΩ, C: 0.033 μF |
| DC Coil | With Diode | Diode reverse voltage: 1000V Diode forward current: 1A |

Specifications

| Model | RU2 (DPDT) | RU4 (4PDT) | RU42 (4PDT) |
|------------------------------|---|--------------------|---------------------------|
| Contact Material | Silver alloy | Silver (gold clad) | Silver-nickel (gold clad) |
| Contact Resistance (*1) | 50 mΩ maximum | | |
| Minimum Applicable Load (*2) | 24V DC, 5 mA | 1V DC, 1 mA | 1V DC, 0.1 mA |
| Operate Time (*3) | 20 ms maximum | | |
| Release Time (*3) | 20 ms maximum | | |
| Power Consumption | AC: 1.1 to 1.4VA (50 Hz), 0.9 to 1.2VA (60 Hz) DC: 0.9 to 1.0W | | |
| Insulation Resistance | 100 MΩ minimum (500V DC megger) | | |
| Dielectric Strength | Between contact and coil: 2500V AC, 1 minute | | |
| | Between contacts of different poles: 2500V AC, 1 minute | | |
| | Between contacts of the same pole: 1000V AC, 1 minute | | |
| Operating Frequency | Electrical: 1800 operations/h maximum Mechanical: 18,000 operations/h maximum | | |
| Vibration Resistance | Damage limits: 10 to 55 Hz, amplitude 0.5 mm Operating extremes: 10 to 55 Hz, amplitude 0.5 mm | | |
| Shock Resistance | Damage limits: 1000 m/s ² Operating extremes: 150 m/s ² | | |
| Mechanical Life | AC: 50,000,000 operations DC: 100,000,000 operations | | 50,000,000 operations |
| Electrical Life | See H-019 and H-021 . | | |
| Operating Temperature (*4) | PCB terminal: -55 to +70°C (no freezing) Others: -55 to +60°C (no freezing) | | |
| Operating Humidity | 5 to 85% RH (no condensation) | | |
| Storage Temperature | -55 to +70°C RH (no freezing) | | |
| Storage Humidity | 5 to 85% RH (no condensation) | | |
| Weight (Approx.) | 35g | | |

Note: Above values are initial values.

*1) Measured using 5V DC, 1A voltage drop method

*2) Measured at operating frequency of 120 operations/min (failure rate level P, reference value)

*3) Measured at the rated voltage (at 20°C), excluding contact bouncing;
Release time of AC relays with RC: 25 ms maximum
Release time of DC relays with diode: 40 ms maximum

*4) Measured at the rated voltage.

RU2 (DPDT Contact)

Dimensions

Plug-in Terminal



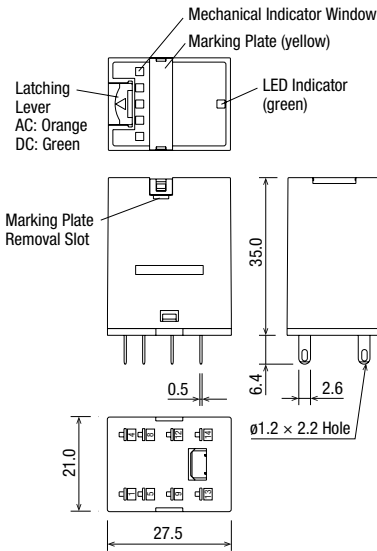
Photo: RU2S-A100

PCB Terminal

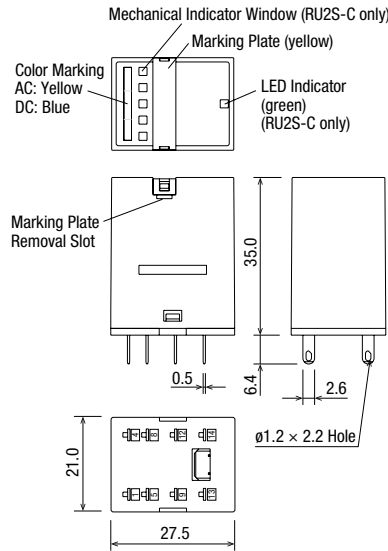


Photo: RU2V-NF-A100

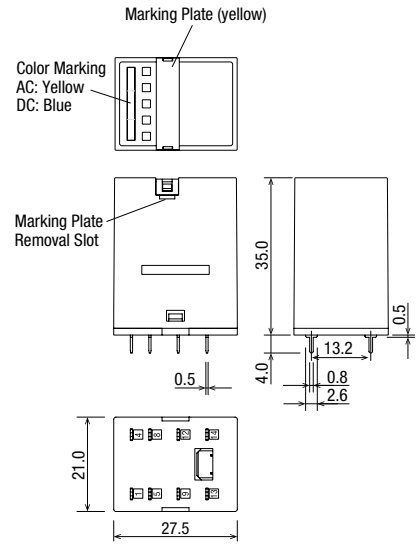
RU2S



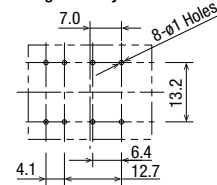
RU2S-C/RU2S-NF



RU2V



Mounting Hole Layout

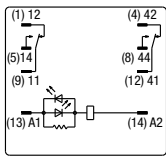


Marking plate removal slot is provided only on one side. Insert a flat screwdriver into the slot to remove the marking plate.

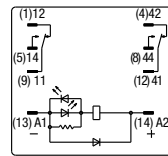
All dimensions in mm.

Internal Connection (Bottom View)

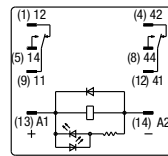
RU2S-* Standard



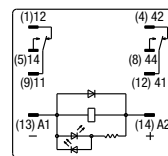
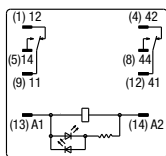
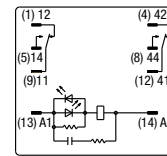
RU2S-*D With Diode



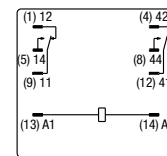
RU2S-*D1 With Diode Reverse Polarity Coil



RU2S-*R With RC



RU2S-NF-*/RU2V-NF-*



Blank or C comes in place of * to represent types with or without a latching lever.

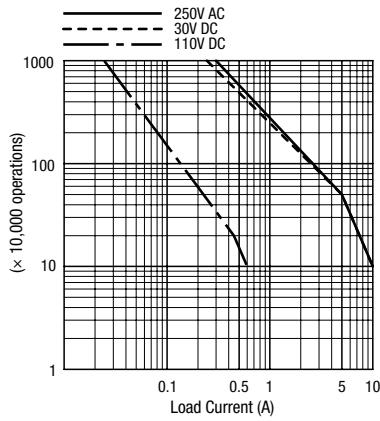
- APEM
- Switches & Pilot Lights
- Control Boxes
- Emergency Stop Switches
- Enabling Switches
- Safety Products
- Explosion Proof
- Terminal Blocks
- Relays & Sockets
- Circuit Protectors
- Power Supplies
- LED Illumination
- Controllers
- Operator Interfaces
- Sensors
- AUTO-ID

- Relays
- Sockets
- DIN Rail Products
- RJ
- RU
- RV8H
- RL

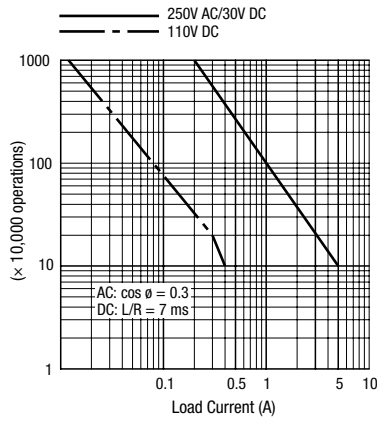
RU Series Universal Relays

Electrical Life Curves

RU2 (Resistive Load)

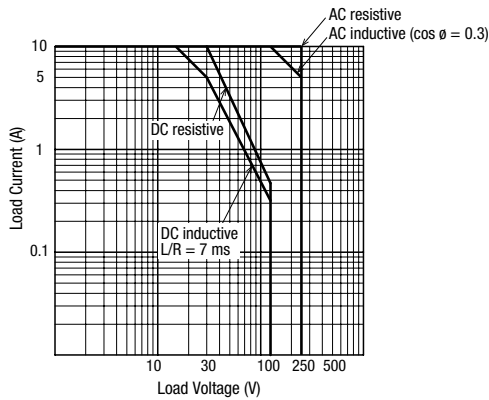


RU2 (Inductive Load)



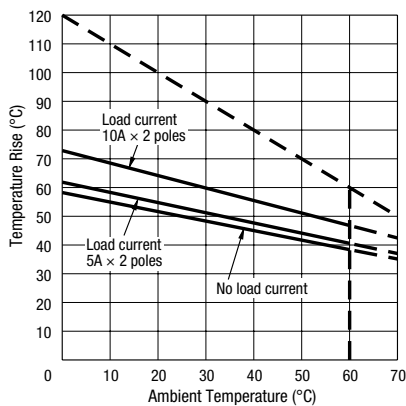
Maximum Switching Current

RU2

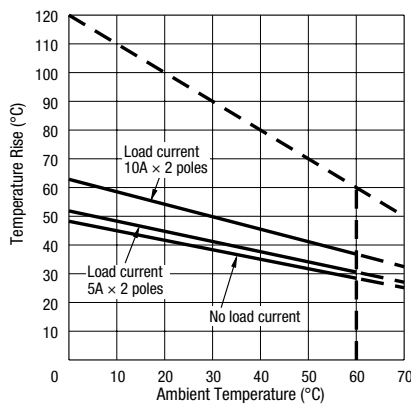


Ambient Temperature vs. Temperature Rise Curves

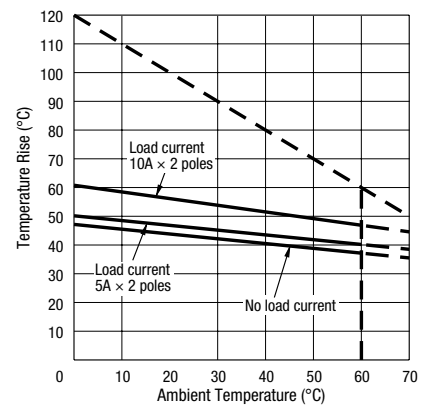
RU2 (AC Coil, 50 Hz)



RU2 (AC Coil, 60 Hz)



RU2 (DC Coil)



The above temperature rise curves show the characteristics when 100% the rated coil voltage is applied. The heat resistance of the coil is 120°C. The slant dashed line indicates the allowable temperature rise for the coil at different ambient temperatures.

- APEM
- Switches & Pilot Lights
- Control Boxes
- Emergency Stop Switches
- Enabling Switches
- Safety Products
- Explosion Proof
- Terminal Blocks
- Relays & Sockets
- Circuit Protectors
- Power Supplies
- LED Illumination
- Controllers
- Operator Interfaces
- Sensors
- AUTO-ID
- Relays
- Sockets
- DIN Rail Products

RU4 (4PDT Contact)

Dimensions

Plug-in Terminal



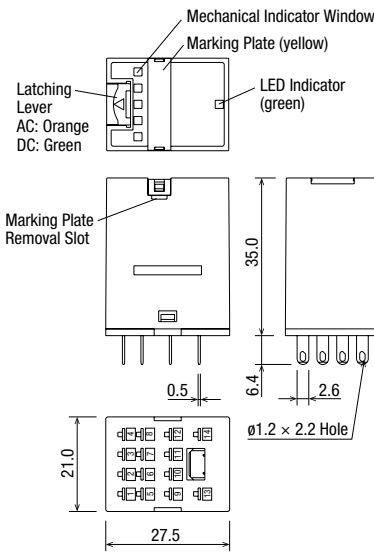
Photo: RU42S-A100

PCB Terminal

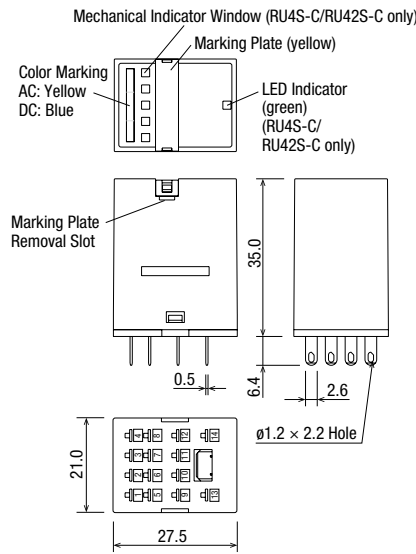


Photo: RU4V-NF-D24

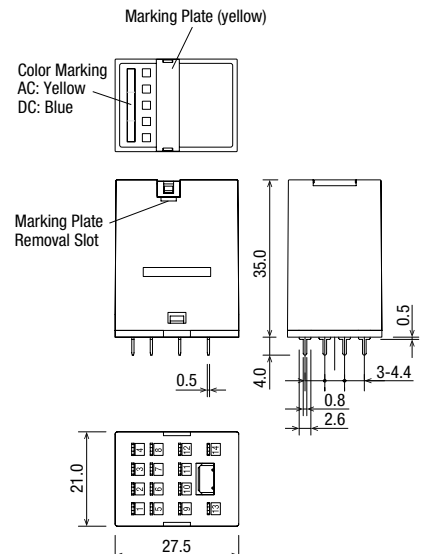
RU4S/RU42S



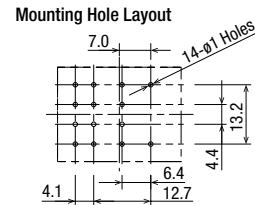
RU4S-C/RU4S-NF
RU42S-C/RU42S-NF



RU4V/RU42V



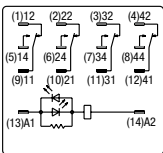
Marking plate removal slot is provided only on one side. Insert a flat screwdriver into the slot to remove the marking plate.



All dimensions in mm.

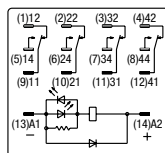
Internal Connection (Bottom View)

RU4S-*/RU42S-*
Standard



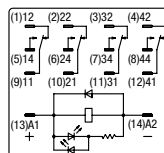
Over 24V AC/DC

RU4S-*D/RU42S-*D
With Diode



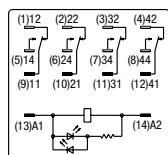
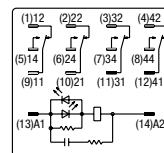
Over 24V DC

RU4S-*D1/RU42S-*D1
With Diode Reverse Polarity Coil

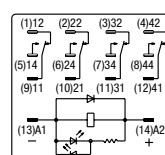


24V DC

RU4S-*R/RU42S-*R
With RC

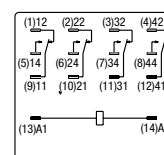


24V AC/DC or less



24V DC or less

RU4S-NF-*/RU4V-NF-*
RU42S-NF-*/RU42V-NF-*



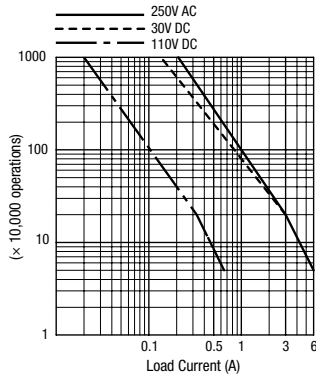
Blank or C comes in place of * to represent types with or without a latching lever.

- APEM
- Switches & Pilot Lights
- Control Boxes
- Emergency Stop Switches
- Enabling Switches
- Safety Products
- Explosion Proof
- Terminal Blocks
- Relays & Sockets
- Circuit Protectors
- Power Supplies
- LED Illumination
- Controllers
- Operator Interfaces
- Sensors
- AUTO-ID
- Relays
- Sockets
- DIN Rail Products
- RU
- RU
- RV8H
- RL

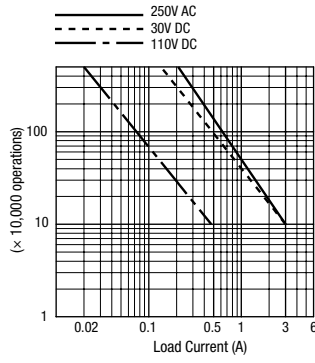
RU Series Universal Relays

Electrical Life Curves

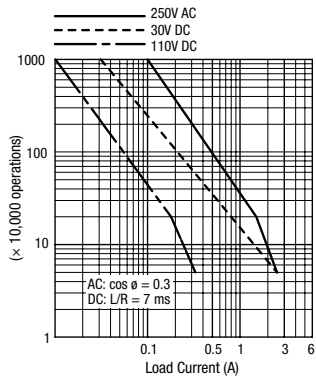
RU4 (Resistive Load)



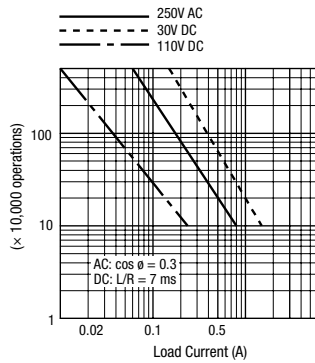
RU42 (Resistive Load)



RU4 (Inductive Load)

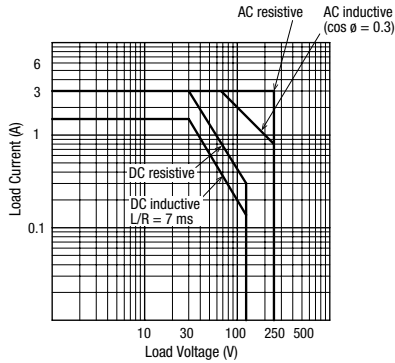


RU42 (Inductive Load)

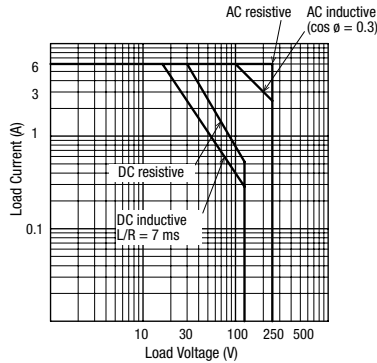


Maximum Switching Current

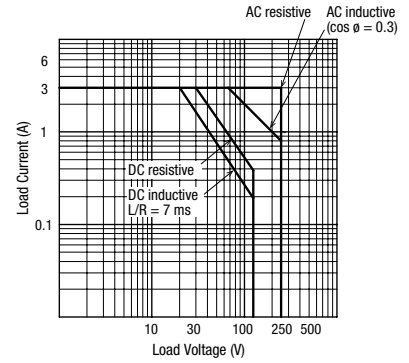
RU4 (Rated Load)



RU4 (Maximum Load)

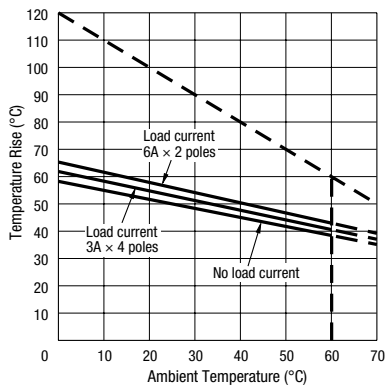


RU42

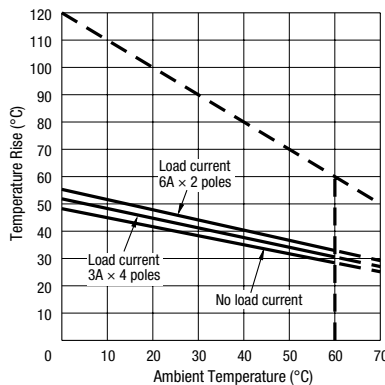


Ambient Temperature vs. Temperature Rise Curves

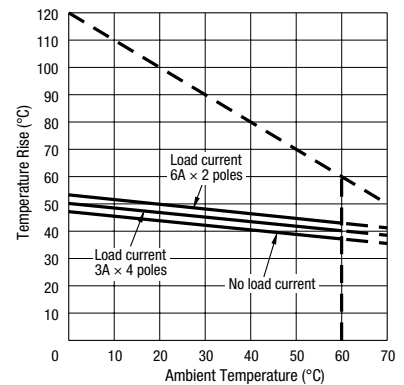
RU4/RU42 (AC Coil, 50 Hz)



RU4/RU42 (AC Coil, 60 Hz)







































RU4/RU42 (DC Coil)



The above temperature rise curves show the characteristics when 100% the rated coil voltage is applied. Load current 6A x 2 poles is for the RU4 only.

The heat resistance of the coil is 120°C. The slant dashed line indicates the allowable temperature rise for the coil at different ambient temperatures.

Applicable Socket

| Relay | Wiring Style | Shape | Part No. | Rated Current | Style | Applicable Spring | | |
|-------------|---------------------|---|----------------|--|---|--------------------|-------------|-----------|
| | | | | | | Hold-down Spring | Wire Spring | |
| RU2 | Front Wiring Socket |  | SM2S-05B | 7A | Standard  | SFA-202 SFA-101 | — | |
| | |  | SM2S-05C (*1) | 7A (UL: 10A) | Finger-safe  | | | |
| | |  | SN2S-05D | 10A | Standard  | SFA-503 | | |
| | |  | SM2S-05DF (*1) | 10A | Finger-safe  | | | |
| | |  | SU2S-11L | 10A 8A (collective mounting) (*3) | Spring clamp (*2)  | SFA-202 SFA-101 | | — |
| | |  | SU2S-21L | 12A | Push-in (*5)  | — | | |
| | Rear Wiring Socket |  | SM2S-51 | 10A | Solder  | SFA-301 SFA-302 | SY4S-51F1 | |
| | |  | SM2S-61 | 10A | PC board  | | | |
| | |  | SM2S-62 | 10A | PC board  | SFA-504 | | SY4S-51F1 |
| RU4 RU42 | Front Wiring Socket |  | SY4S-05B | 7A | Standard  | SFA-202 SFA-101 | — | |
| | |  | SY4S-05C (*1) | 7A | Finger-safe  | | | |
| | |  | SN4S-05D | 6A | Standard  | SFA-502 | | |
| | |  | SY4S-05DF (*1) | 6A | Finger-safe  | SFA-502 | | |
| | |  | SU4S-11L | 6A (4-pole) 10A (2-pole) 8A (2-pole, collective mounting) (*3) | Spring clamp (*2)  | SFA-202 SFA-101 | | — |
| | |  | SU4S-21L | 8A | Push-in (*5)  | — | | |
| | Rear Wiring Socket |  | SY4S-51 | 7A | Solder  | SFA-301 SFA-302 | SY4S-51F1 | |
| | |  | SY4S-61 | 7A | PC board  | | | |
| | |  | SY4S-62 | 7A | PC board  | SFA-504 | | SY4S-51F1 |

*1) Finger-safe cannot be used with ring terminal.

*2) SU2S-11L and SU4S-11L are spring-clamp socket which does not require tightening screws. Stranded wire, solid wire, and ferrule can be attached using a screwdriver.

*3) When using SU2S-11L and SU4S-11L at rated current 8A and above, maintain at least 10mm distance from the adjacent SU socket.

*4) Front wiring socket can be mounted directly on DIN rail and mounting panel (some sockets need spacers for the ends).

*5) SU2S-21L and SU4S-21L are Push-in socket which does not require tightening screws. Stranded wire, solid wire, and ferrule can be attached using a screwdriver.

- APEM
- Switches & Pilot Lights
- Control Boxes
- Emergency Stop Switches
- Enabling Switches
- Safety Products
- Explosion Proof
- Terminal Blocks
- Relays & Sockets
- Circuit Protectors
- Power Supplies
- LED Illumination
- Controllers
- Operator Interfaces
- Sensors
- AUTO-ID

Relays

- Sockets
- DIN Rail Products

RJ

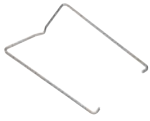







RU

RV8H

RL

RU Series Universal Relays

Hold-down Springs

| Style | Shape | Material | Part No. | Ordering No. | Package Quantity |
|-------------|---|-----------------|-----------|---------------|------------------|
| Wire Spring |  | Stainless Steel | SY4S-51F1 | SY4S-51F1PN10 | 10 |
| Leaf Spring |  | | SFA-101 | SFA-101PN20 | 10 pairs |
| |  | | SFA-202 | SFA-202PN20 | |
| |  | | SFA-301 | SFA-301PN20 | |
| |  | | SFA-302 | SFA-302PN20 | |
| |  | | SFA-502 | SFA-502PN20 | |
| |  | | SFA-503 | SFA-503PN20 | |
| |  | | SFA-504 | SFA-504PN10 | |

- A relay needs a pair of leaf springs, except for SFA-504 (one spring per relay).
- When the wire spring SY4S-51F1 or leaf spring SFA-504 is used on a relay with latching lever, lever cannot be opened or closed.
- Leaf springs (except for the leaf spring SFA-504) cannot be removed after being installed on a socket.








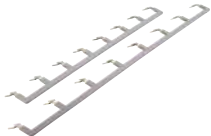
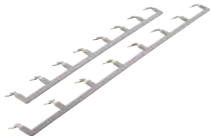
RJ

RU

RV8H

RL

Accessories for Sockets

| Name | Shape | Specifications | Part No. | Ordering No. | Package Quantity | Remarks |
|----------------------------|---|---|----------|--------------|------------------|---|
| DIN Rail |  | Aluminum Weight: Approx. 200g | BAA1000 | BAA1000PN10 | 10 | Length: 1m Width: 35 mm |
| End Clip |  | Zinc-plated steel Weight: Approx. 15g | BNL5 | BNL5PN10 | 10 | Used on a DIN rail to fasten relay sockets |
| |  | | BNL6 | BNL6PN10 | 10 | |
| DIN Rail Spacer |  | Plastic (black) | SA-406B | SA-406B | 1 | Thickness: 5 mm Used for adjusting spacing between sockets mounted on a DIN rail |
| End Spacer |  | Plastic (black) | SA-203B | SA-203B | 1 | Used for mounting DIN rail mount sockets directly on a panel surface |
| |  | | SA-204B | SA-204B | 1 | |
| Jumper |  | Rated current: 3A (*1) Brass jumper with ABS sheath Rated current: 3A Weight: Approx. 3g | SU9Z-J5 | SU9Z-J5PN10 | 10 | Used for interconnecting relay coil terminals on a maximum of five SU sockets; can be cut to required lengths |
| Jumper (for 2-pole socket) |  | Rated current: 10A (*1) Brass (Nickel-plated) with polyprene sheath | SM9Z-JF2 | SM9Z-JF2PN10 | 10 | Used for interconnecting relay coil terminals on SM2S-05DF sockets; can be cut to required length. No. of sockets: SM9Z-JF2: 2 SM9Z-JF5: 5 SM9Z-JF8: 8 |
| | | | SM9Z-JF5 | SM9Z-JF5PN10 | | |
| | | | SM9Z-JF8 | SM9Z-JF8PN10 | | |
| Jumper (for 4-pole socket) |  | Rated current: 10A (*1) Brass (Nickel-plated) with polyprene sheath | SY9Z-JF2 | SY9Z-JF2PN10 | 10 | Used for interconnecting relay coil terminals on SY4S-05DF sockets; can be cut to required length SY9Z-JF2: 2 SY9Z-JF5: 5 SY9Z-JF8: 8 |
| | | | SY9Z-JF5 | SY9Z-JF5PN10 | | |
| | | | SY9Z-JF8 | SY9Z-JF8PN10 | | |

*1) Ensure that the total current to the jumper does not exceed the rated current.

- APEM
- Switches & Pilot Lights
- Control Boxes
- Emergency Stop Switches
- Enabling Switches
- Safety Products
- Explosion Proof
- Terminal Blocks
- Relays & Sockets
- Circuit Protectors
- Power Supplies
- LED Illumination
- Controllers
- Operator Interfaces
- Sensors
- AUTO-ID
- Relays
- Sockets
- DIN Rail Products

RJ

RU

RV8H

RL

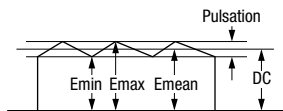
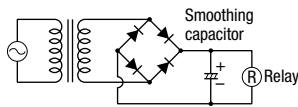
Safety Precautions

- Turn off the power to the relay before starting installation, removal, wiring, maintenance, and inspection of the relays. Failure to turn power off may cause electrical shock or fire hazard.
- Observe specifications and rated values, otherwise electrical shock or fire hazard may be caused.
- Use wires of the proper size to meet the voltage and current requirements. Tighten the terminal screws on the relay socket to the proper tightening torque.
- Before operating the latching lever, turn off the power to the RU relay. After checking the circuit, return the latching lever to the original position.
- Do not use the latching lever as a switch.
- The durability of the latching lever is a minimum of 100 operations.
- When using DC loads on 4PDT relays, apply a positive voltage to terminals of neighboring poles and a negative voltage to the other terminals of neighboring poles to prevent the possibility of short circuits.
- DC relays with a diode have a polarity in the coil terminals.
- The surge absorbing element on AC relays with RC or DC relays. with diode is provided to absorb the counter electromotive force generated by the coil. When the relay is subject to an excessive external surge voltage, the surge absorbing element may be damaged. Add another surge absorbing provision to the relay to prevent damage.

Instructions

Driving Circuit for Relays

1. To make sure of correct relay operation, apply rated voltage to the relay coil.
2. Input voltage for the DC coil:
A complete DC voltage is best for the coil power to make sure of stable relay operation. When using a power supply containing a ripple voltage, suppress the ripple factor within 5%. When power is supplied through a rectification circuit, the relay operating characteristics, such as pickup voltage and dropout voltage, depend on the ripple factor. Connect a smoothing capacitor for better operating characteristics as shown below.



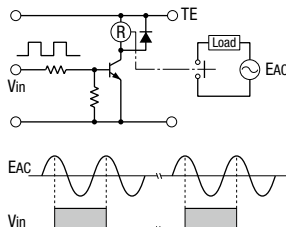
$$\text{Ripple factor (\%)} = \frac{E_{\max} - E_{\min}}{E_{\text{mean}}} \times 100\%$$

E_{\max} = Maximum of pulsating current

E_{\min} = Minimum of pulsating current

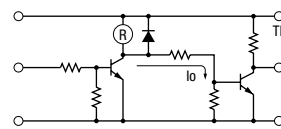
E_{mean} = DC mean value

3. Operating the relay in synchronism with AC load:
If the relay operates in synchronism with the AC power voltage of the load, the relay life may be reduced. If this is the case, select a relay in consideration of the required reliability for the load. Or, make the relay turn on and off irrespective of the AC power phase or near the point where the AC phase crosses zero voltage.

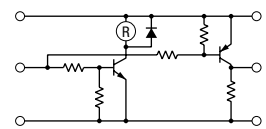


4. Leakage current while relay is off:
When driving an element at the same time as the relay operation, a special consideration is needed for the circuit design. As shown in the incorrect circuit below, Leakage current (I_o) flows through the relay coil while the relay is off. Leakage current causes the coil release failure or adversely affects the vibration resistance and shock resistance. Design a circuit as shown in the correct example.

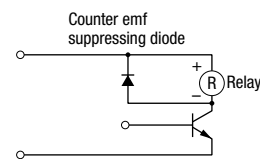
Incorrect



Correct



5. Surge suppression for transistor driving circuits:
When the relay coil is turned off, a high-voltage pulse is generated, causing the transistor to deteriorate and sometimes to break. Be sure to connect a diode to suppress the counter electromotive force. Then, the coil release time becomes slightly longer. To shorten the coil release time, connect a Zener diode between the collector and emitter of the transistor. Select a Zener diode with a Zener voltage slightly higher than the power voltage.



- APEM
- Switches & Pilot Lights
- Control Boxes
- Emergency Stop Switches
- Enabling Switches
- Safety Products
- Explosion Proof
- Terminal Blocks
- Relays & Sockets
- Circuit Protectors
- Power Supplies
- LED Illumination
- Controllers
- Operator Interfaces
- Sensors
- AUTO-ID

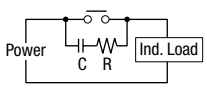
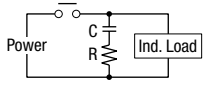
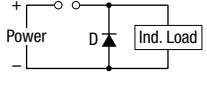
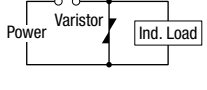
- Relays
- Sockets
- DIN Rail Products

- RJ
- RU
- RV8H
- RL

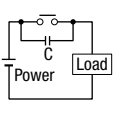
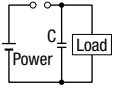
Instructions

Protection for Relay Contacts

- The contact ratings show maximum values. Make sure that these values are not exceeded. When an inrush current flows through the load, the contact may become welded. If this is the case, connect a contact protection circuit, such as a current limiting resistor.
- Contact protection circuit:
When switching an inductive load, arcing causes carbides to form on the contacts, resulting in an increased contact resistance. In consideration of contact reliability, contact life, and noise suppression, use of a surge absorbing circuit is recommended. Note that the release time of the load becomes slightly longer. Check the operation using the actual load. Incorrect use of a contact protection circuit will adversely affect switching characteristics. Four typical examples of contact protection circuits are shown in the following table:

| | | |
|----------|---|---|
| RC |  | This protection circuit can be used when the load impedance is smaller than the RC impedance in an AC load power circuit. R: Resistor of approximately the same resistance value as the load C: 0.1 to 1 μF |
| |  | This protection circuit can be used for both AC and DC load power circuits. R: Resistor of approximately the same resistance value as the load C: 0.1 to 1 μF |
| Diode |  | This protection circuit can be used for DC load power circuits. Use a diode with the following ratings. Reverse withstand voltage: Power voltage of the load circuit × 10 Forward current: More than the load current |
| Varistor |  | This protection circuit can be used for both AC and DC load power circuits. For a best result, when using on a power voltage of 24 to 48V AC/DC, connect a varistor across the load. When using on a power voltage of 100 to 240V AC/DC, connect a varistor across the contacts. |

- Do not use a contact protection circuit as shown below:

| | |
|---|---|
|  | This protection circuit is very effective in arc suppression when opening the contacts. But, the capacitor is charged while the contacts are opened. When the contacts are closed, the capacitor is discharged through the contacts, increasing the possibility of contact welding. |
|  | This protection circuit is very effective in arc suppression when opening the contacts. But, when the contacts are closed, a current flows to charge the capacitor, causing contact welding. |

Generally, switching a DC inductive load is more difficult than switching a DC resistive load. Using an appropriate arc suppressor, however, will improve the switching characteristics of a DC inductive load.

Other Precautions

- General notice:
To maintain the initial characteristics, do not drop the relay or shock the relay.
The relay cover cannot be removed from the base during normal operation. To maintain the initial characteristics, do not remove the relay cover.
Use the relay in environments free from condensation of dust, sulfur dioxide (SO₂), and hydrogen sulfide (H₂S).
Make sure that the coil voltage does not exceed the applicable coil voltage range.
- Connecting outputs to electronic circuits:
When the output is connected to a load which responds very quickly, such as an electronic circuit, contact bouncing causes incorrect operation of the load. Take the following measures into consideration.
Connect an integral circuit.
Suppress the pulse voltage due to bouncing within the noise margin of the load.
- UL- and CSA-approved ratings may differ from product rated values determined by IDEC.
- Do not use relays in the vicinity of strong magnetic field as this may affect relay operation.
DC diode type has polarity.
The surge absorbing element on AC relays with RC or DC relays with diode is provided to absorb the counter electromotive force generated by the coil. When the relay is subject to an excessive external surge voltage, the surge absorbing element may be damaged. Add another surge absorbing provision to the relay to prevent damage.

Ordering Terms and Conditions

Thank you for using IDEC Products.

By purchasing products listed in our catalogs, datasheets, and the like (hereinafter referred to as "Catalogs") you agree to be bound by these terms and conditions. Please read and agree to the terms and conditions before placing your order.

1. Notes on contents of Catalogs

- (1) Rated values, performance values, and specification values of IDEC products listed in this Catalog are values acquired under respective conditions in independent testing, and do not guarantee values gained in combined conditions.
Also, durability varies depending on the usage environment and usage conditions.
- (2) Reference data and reference values listed in Catalogs are for reference purposes only, and do not guarantee that the product will always operate appropriately in that range.
- (3) The specifications / appearance and accessories of IDEC products listed in Catalogs are subject to change or termination of sales without notice, for improvement or other reasons.
- (4) The content of Catalogs is subject to change without notice.

2. Note on applications

- (1) If using IDEC products in combination with other products, confirm the applicable laws / regulations and standards.
Also, confirm that IDEC products are compatible with your systems, machines, devices, and the like by using under the actual conditions. IDEC shall bear no liability whatsoever regarding the compatibility with IDEC products.
- (2) The usage examples and application examples listed in Catalogs are for reference purposes only. Therefore, when introducing a product, confirm the performance and safety of the instruments, devices, and the like before use. Furthermore, regarding these examples, IDEC does not grant license to use IDEC products to you, and IDEC offers no warranties regarding the ownership of intellectual property rights or non-infringement upon the intellectual property rights of third parties.
- (3) When using IDEC products, be cautious when implementing the following.
 - i. Use of IDEC products with sufficient allowance for rating and performance
 - ii. Safety design, including redundant design and malfunction prevention design that prevents other danger and damage even in the event that an IDEC product fails
 - iii. Wiring and installation that ensures the IDEC product used in your system, machine, device, or the like can perform and function according to its specifications
- (4) Continuing to use an IDEC product even after the performance has deteriorated can result in abnormal heat, smoke, fires, and the like due to insulation deterioration or the like. Perform periodic maintenance for IDEC products and the systems, machines, devices, and the like in which they are used.
- (5) IDEC products are developed and manufactured as general-purpose products for general industrial products. They are not intended for use in the following applications, and in the event that you use an IDEC product for these applications, unless otherwise agreed upon between you and IDEC, IDEC shall provide no guarantees whatsoever regarding IDEC products.
 - i. Use in applications that require a high degree of safety, including nuclear power control equipment, transportation equipment (railroads / airplanes / ships / vehicles / vehicle instruments, etc.), equipment for use in outer space, elevating equipment, medical instruments, safety devices, or any other equipment, instruments, or the like that could endanger life or human health
 - ii. Use in applications that require a high degree of reliability, such as provision systems for gas / waterworks / electricity, etc., systems that operate continuously for 24 hours, and settlement systems
 - iii. Use in applications where the product may be handled or used deviating from the specifications or conditions / environment listed in the Catalogs, such as equipment used outdoors or applications in environments subject to chemical pollution or electromagnetic interference
If you would like to use IDEC products in the above applications, be sure to consult with an IDEC sales representative.

3. Inspections

We ask that you implement inspections for IDEC products you purchase without delay, as well as thoroughly keep in mind management/maintenance regarding handling of the product before and during the inspection.

4. Warranty

- (1) Warranty period
The warranty period for IDEC products shall be one (1) year after purchase or delivery to the specified location. However, this shall not apply in cases where there is a different specification in the Catalogs or there is another agreement in place between you and IDEC.
- (2) Warranty scope
Should a failure occur in an IDEC product during the above warranty period for reasons attributable to IDEC, then IDEC shall replace or repair that product, free of charge, at the purchase location / delivery location of the product, or an IDEC service base. However, failures caused by the following reasons shall be deemed outside the scope of this warranty.
 - i. The product was handled or used deviating from the conditions / environment listed in the Catalogs
 - ii. The failure was caused by reasons other than an IDEC product
 - iii. Modification or repair was performed by a party other than IDEC
 - iv. The failure was caused by a software program of a party other than IDEC
 - v. The product was used outside of its original purpose
 - vi. Replacement of maintenance parts, installation of accessories, or the like was not performed properly in accordance with the user's manual and Catalogs
 - vii. The failure could not have been predicted with the scientific and technical standards at the time when the product was shipped from IDEC
 - viii. The failure was due to other causes not attributable to IDEC (including cases of force majeure such as natural disasters and other disasters)Furthermore, the warranty described here refers to a warranty on the IDEC product as a unit, and damages induced by the failure of an IDEC product are excluded from this warranty.

5. Limitation of liability

The warranty listed in this Agreement is the full and complete warranty for IDEC products, and IDEC shall bear no liability whatsoever regarding special damages, indirect damages, incidental damages, or passive damages that occurred due to an IDEC product.

6. Service scope

The prices of IDEC products do not include the cost of services, such as dispatching technicians. Therefore, separate fees are required in the following cases.

- (1) Instructions for installation / adjustment and accompaniment at test operation (including creating application software and testing operation, etc.)
- (2) Maintenance inspections, adjustments, and repairs
- (3) Technical instructions and technical training
- (4) Product tests or inspections specified by you

The above content assumes transactions and usage within your region. Please consult with an IDEC sales representative regarding transactions and usage outside of your region. Also, IDEC provides no guarantees whatsoever regarding IDEC products sold outside your region.

IDEC CORPORATION

Head Office 6-64, Nishi-Miyahara-2-Chome, Yodogawa-ku, Osaka 532-0004, Japan

USA IDEC Corporation
EMEA APEM SAS

Singapore IDEC Izumi Asia Pte. Ltd.
Thailand IDEC Asia (Thailand) Co., Ltd.
India IDEC Controls India Private Ltd.

China IDEC (Shanghai) Corporation
IDEC Izumi (H.K.) Co., Ltd.
Taiwan IDEC Taiwan Corporation

 www.idec.com

Japan IDEC Corporation

Specifications and other descriptions in this brochure are subject to change without notice.

2023 IDEC Corporation, All Rights Reserved.

