

DRM270524LT

Weidmüller Interface GmbH & Co. KG
Klingenbergstraße 26
D-32758 Detmold
Germany

www.weidmueller.com

Product image

Similar to illustration

Individual relays within the D-SERIES DRM

- 2 CO contacts
- AC coils
- With integrated status LED and test button

General ordering data

Version	D-SERIES DRM, Relay, Number of contacts: 2, CO contact, AgNi flash gold-plated, Rated control voltage: 24 V AC, Continuous current: 10 A, Plug-in connection
Order No.	7760056073
Type	DRM270524LT
GTIN (EAN)	4032248855827
Qty.	20 pc(s).

Creation date July 31, 2024 11:25:59 AM CEST

Catalogue status 13.07.2024 / We reserve the right to make technical changes.

DRM270524LT

Weidmüller Interface GmbH & Co. KG

Klingenbergstraße 26

D-32758 Detmold

Germany

www.weidmueller.com

Technical data

Dimensions and weights

Depth	35.7 mm	Depth (inches)	1.406 inch
Height	27.4 mm	Height (inches)	1.079 inch
Width	21 mm	Width (inches)	0.827 inch
Net weight	34.85 g		

Temperatures

Storage temperature	-40 °C...70 °C	Operating temperature	-40 °C...55 °C
Humidity	35...85 % rel. humidity, no condensation		

Rated data UL

Certificate No. (cURus)	E312083
-------------------------	---------

Control side

Rated control voltage	24 V AC	Rated current AC	62.4 mA (50 Hz), 52.2 mA (60 Hz)
Power rating	1.0...1.2VA (60HZ)	Coil resistance	160 Ω ± 10 %
Coil tolerance	10 %	Status indicator	red LED

Load side

Rated switching voltage	250 V AC	Continuous current	10 A
Max. switching frequency at rated load	0.1 Hz	Max. switching voltage, AC	250 V
Inrush current	20 A / 50 ms	AC switching capacity (resistive), max.	2500 VA
DC switching capacity (resistive), max.	240 W @ 24 V	Switch-on delay	< 20 ms
Switch-off delay	< 20 ms	Contact type	2 CO contact (AgNi flash gold-plated)
Mechanical service life	20 x 10 ⁶ switching cycles	Min. switching power	10 mA @ 12 V, 100 mA @ 5 V

General data

Test button available	Yes	
Version of test button	Lockable test button, Momentary test button	
Mechanical switch position indicator	Yes	
Colour	Transparent	
UL94 flammability rating component	Component	Relay cover
	UL94 flammability rating	V-2
	Component	Relay baseplate
	UL94 flammability rating	V-0
	Component	Relay status indicator
	UL94 flammability rating	HB
	Component	Relay test button
	UL94 flammability rating	HB

DRM270524LT

Weidmüller Interface GmbH & Co. KG

Klingenbergstraße 26

D-32758 Detmold

Germany

www.weidmueller.com

Technical data

Insulation coordination

Rated voltage	250 V	Pollution severity	2
Surge voltage category	III	Clearance and creepage distances for control side - load side	≥ 5.5 mm
Dielectric strength for control side - load side	1.8 kV _{eff} / 1 min.	Dielectric strength of neighbouring contacts	1 kV _{eff} / 1 min
Dielectric strength of open contact	1 kV _{eff} / 1 min	Impulse withstand voltage	6 kV (1.2/50 μs)
Protection degree	IP20		

Further details of approvals / standards

Certificate No. (cURus)	E312083
-------------------------	---------

Connection data

Wire connection method	Plug-in connection
------------------------	--------------------

Classifications

ETIM 6.0	EC001437	ETIM 7.0	EC001437
ETIM 8.0	EC001437	ETIM 9.0	EC001437
ECLASS 9.0	27-37-16-01	ECLASS 9.1	27-37-16-01
ECLASS 10.0	27-37-16-01	ECLASS 11.0	27-37-16-01
ECLASS 12.0	27-37-16-01	ECLASS 13.0	27-37-16-01

Environmental Product Compliance

REACH SVHC	/
RoHS Compliance Status	Compliant without exemption

Approvals

Approvals



ROHS	Conform
UL File Number Search	UL Website
Certificate No. (cURus)	E312083

Downloads

Approval/Certificate/Document of Conformity	EU Konformitätserklärung / EU Declaration of Conformity
Engineering Data	CAD data – STEP
Product Change Notification	20230124 Product consolidation D-SERIES DRM relays 20230124 Produktkonsolidierung D-SERIES DRM Relais
User Documentation	FL_D-SERIES_DRM2CO_LOAD_GUIDE
Catalogues	Catalogues in PDF-format
Brochures	

DRM270524LT

Weidmüller Interface GmbH & Co. KG
 Klingenbergstraße 26
 D-32758 Detmold
 Germany

www.weidmueller.com

Drawings

Wiring diagram

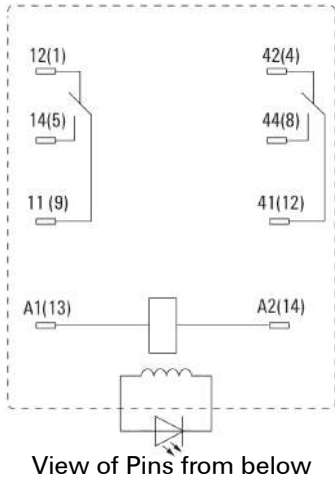

Graph

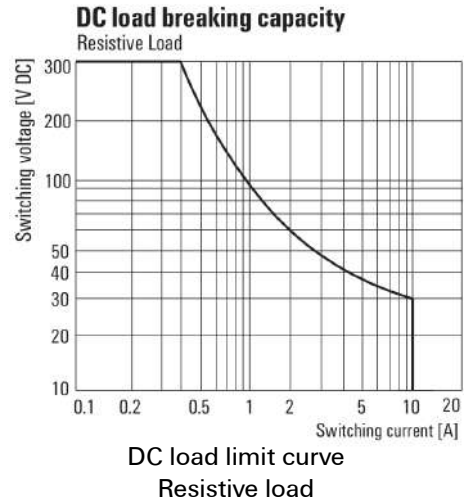

Graph

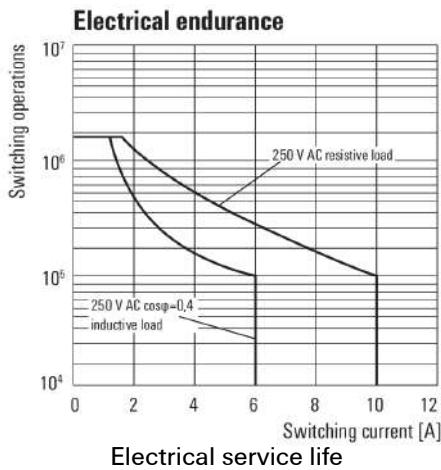

Graph

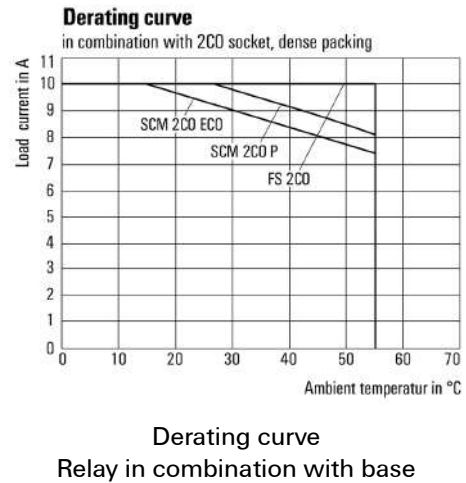

Graph

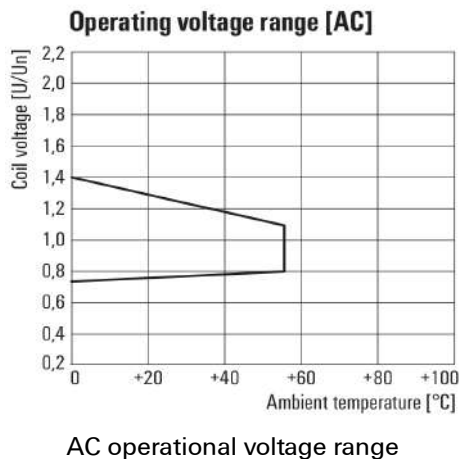

Dimensional drawing

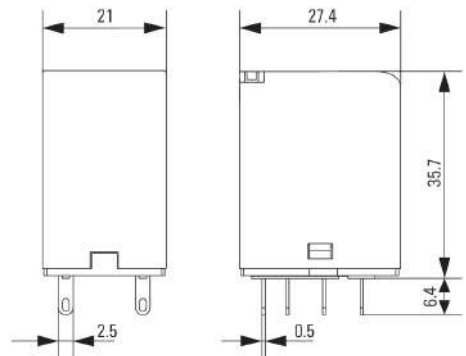

Data sheet

DRM270524LT

Weidmüller Interface GmbH & Co. KG
 Klingenbergstraße 26
 D-32758 Detmold
 Germany

www.weidmueller.com

Drawings

Miscellaneous

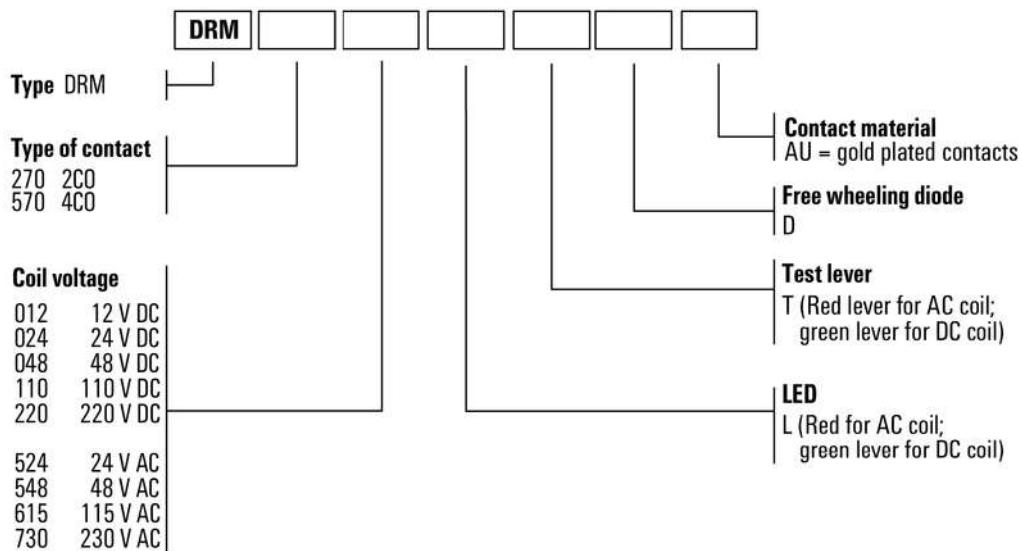

Type codes