

Similar to illustration

Pin 1 ... 4: 0.34 mm²

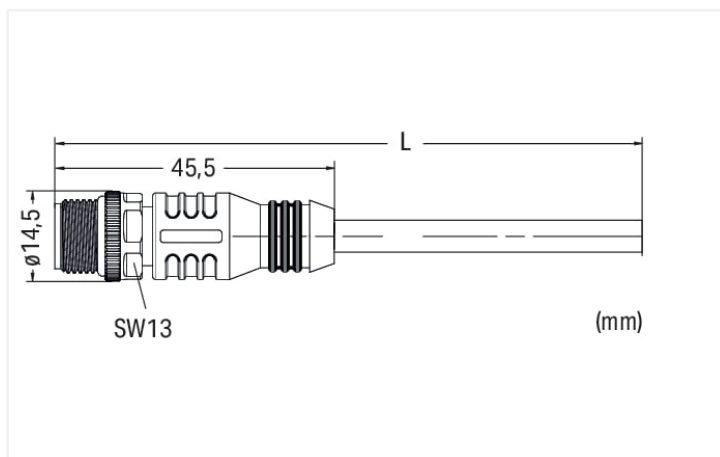
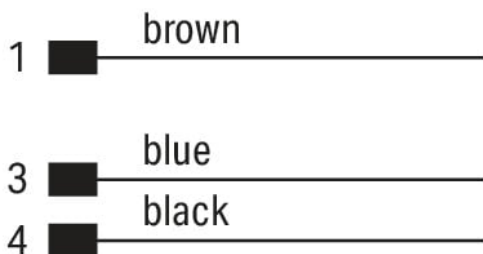

Technical data

General information

Operating voltage	300 VDC
Protection type	IP67
Ambient (operating) temperature (static)	-40 ... +80 °C
Ambient (operating) temperature (dynamic)	-20 ... +60 °C

Cable

Cable length	5 m
Sheathed cable color	black
Sheathed cable diameter	3.8 mm

Connector

Connection type	M12 plug - free end
Pole number	3
Cable connection direction to mating direction	0°
Connector interface coding (cable/adapter) 1 1	A-coded



Commercial data

PU (SPU)	1 pcs
Country of origin	CN
GTIN	4066966489798
Customs tariff number	85444995900

Environmental Product Compliance

RoHS Compliance Status	Compliant, No Exemption
------------------------	-------------------------

Downloads

Environmental Product Compliance

Compliance Search
Environmental Product Compliance 756-6311/030-050 