

# C-RC 6/M8 DIN - Ring cable lug

3240086

<https://www.phoenixcontact.com/in/products/3240086>

Please be informed that the data shown in this PDF document is generated from our online catalog. Please find the complete data in the user documentation. Our general terms of use for downloads are valid.



Ring cable lug, non-insulated, 2.6 ... 6 mm<sup>2</sup>, M8

## Your advantages

- The CRIMPFOX-RC... tools from our CRIMPFOX range of crimping pliers are available for optimum crimping
- The hard-soldered press zone enables maximum conductor pull-out values to be achieved
- The ring cable lugs without plastic sleeve are made from high-quality tin-plated electrolytic copper for maximum protection against corrosion

## Commercial data

Item number	3240086
Packing unit	50 pc
Minimum order quantity	50 pc
Sales key	BH3
Product key	BH3422
Catalog page	Page 490 (C-3-2019)
GTIN	4046356453035
Weight per piece (including packing)	2.134 g
Weight per piece (excluding packing)	2.088 g
Customs tariff number	85369010
Country of origin	CN

# C-RC 6/M8 DIN - Ring cable lug

3240086

<https://www.phoenixcontact.com/in/products/3240086>

## Technical data

### Product properties

Product type	Connector
--------------	-----------

### Data management status

Article revision	00
------------------	----

### Dimensions

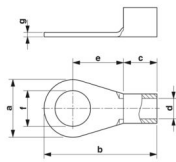
Dimensional drawing	
Width	14 mm
Length of the insulating material sleeve	6 mm
Maximum stripping length	9 mm
Distance from the center to the insulating material sleeve	13 mm
Min. material thickness	1 mm
Inner dimensions of the insulating collar	3.6 mm

### Internal dimensions

Internal diameter	8.4 mm
-------------------	--------

### Material specifications

Color	silver
Material	Copper
Coating	tin-plated

### Environmental and real-life conditions

#### Ambient conditions

Ambient temperature (operation)	110 °C
---------------------------------	--------

### Standards and regulations

Design according to standard	DIN 46234
------------------------------	-----------

# C-RC 6/M8 DIN - Ring cable lug

3240086

<https://www.phoenixcontact.com/in/products/3240086>



## Drawings

Dimensional drawing

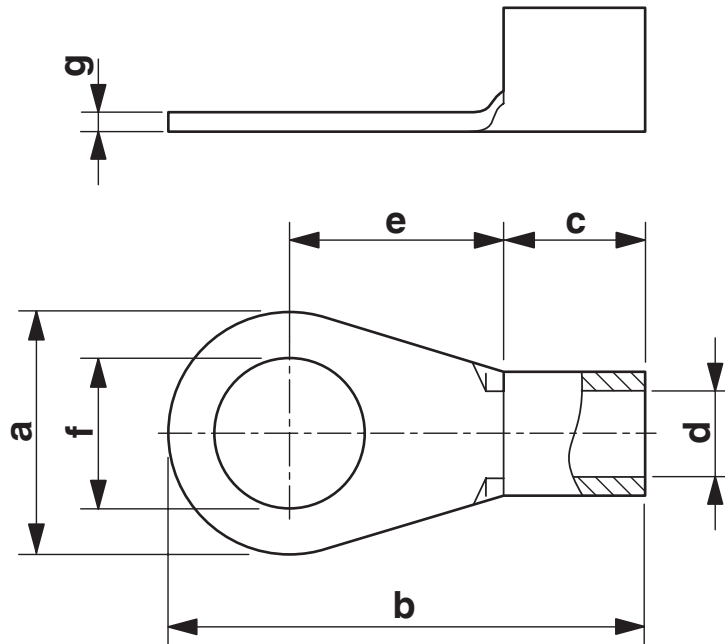

# C-RC 6/M8 DIN - Ring cable lug



3240086

<https://www.phoenixcontact.com/in/products/3240086>

## Classifications

### ECLASS

ECLASS-11.0	27400204
ECLASS-13.0	27400204
ECLASS-12.0	27400204

### ETIM

ETIM 9.0	EC001052
----------	----------

### UNSPSC

UNSPSC 21.0	27121700
-------------	----------

# C-RC 6/M8 DIN - Ring cable lug



3240086

<https://www.phoenixcontact.com/in/products/3240086>

## Environmental product compliance

### EU RoHS

Fulfills EU RoHS substance requirements	Yes, No exemptions
---	--------------------

### China RoHS

Environment friendly use period (EFUP)	EFUP-E
	No hazardous substances above the limits

### EU REACH SVHC

REACH candidate substance (CAS No.)	No substance above 0.1 wt%
-------------------------------------	----------------------------

Phoenix Contact 2024 © - all rights reserved  
<https://www.phoenixcontact.com>

PHOENIX CONTACT (I) Pvt. Ltd.  
A-58/2, Okhla Industrial Area, Phase - II, New Delhi-110 020

+91.1275.71420  
[info@phoenixcontact.co.in](mailto:info@phoenixcontact.co.in)