

# FL SWITCH 3008 - Industrial Ethernet Switch



2891031

<https://www.phoenixcontact.com/in/products/2891031>

Please be informed that the data shown in this PDF document is generated from our online catalog. Please find the complete data in the user documentation. Our general terms of use for downloads are valid.



Managed Ethernet switch with eight RJ45 ports at 10/100 Mbps and operating temperature of -10°C ... +60°C

## Product description

FL SWITCH 3000 managed industrial Ethernet switches combine extensive network performance and security features with complete IEEE redundancy (STP/RSTP/MST) and 15 ms recovery time extended ring redundancy. Unique web customization provides a simplified user interface for today's applications and scalable functionality for future needs. A comprehensive mix of fiber optic and copper port connections meets a wide range of applications.

## Your advantages

- RJ45 ports support a transmission speed of 10/100 Mbps
- Fiber-optic ports support 100 Mbps
- -40 to 75°C and -10 to 60°C ambient temperature versions
- Extensive web diagnostics with configurable LED and remote alarm contacts
- Security options with cable locking
- Secure web-based and SNMP-based management
- Unique cleanup function hides unused configuration pages, reducing complexity, maintenance and startup times
- Auto negotiation and autocrossing detection simplifies installation and setup

## Commercial data

Item number	2891031
Packing unit	1 pc
Minimum order quantity	1 pc
Sales key	DNN
Product key	DNN125
Catalog page	Page 314 (C-6-2019)
GTIN	4046356659123
Weight per piece (including packing)	836 g
Weight per piece (excluding packing)	622 g
Customs tariff number	85176200
Country of origin	TW

# FL SWITCH 3008 - Industrial Ethernet Switch



2891031

<https://www.phoenixcontact.com/in/products/2891031>

## Technical data

### Dimensions

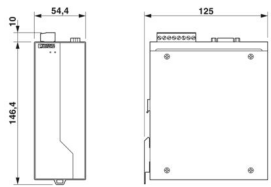
Dimensional drawing	
Width	54.4 mm
Height	146.4 mm
Depth	125 mm

### Notes

Note on application	
Note on application	Only for industrial use
Utilization restriction	
EMC note	EMC: class A product, see manufacturer's declaration in the download area

### Material specifications

Housing material	Aluminum
------------------	----------

### Mounting

Mounting type	DIN rail mounting
---------------	-------------------

### Interfaces

Ethernet (RJ45)	
Connection method	RJ45
Note on the connection method	Auto negotiation and autocrossing
Transmission speed	10/100 Mbps
Transmission physics	Ethernet in RJ45 twisted pair
Transmission length	100 m
No. of channels	8 (RJ45 ports)

### Product properties

Product type	Switch
Product family	Managed Switch 3000
Type	Block design
MTTF	49.8 Years (MIL-HDBK-217F standard, temperature 25°C, operating cycle 100%)

### Data management status

# FL SWITCH 3008 - Industrial Ethernet Switch



2891031

<https://www.phoenixcontact.com/in/products/2891031>

Article revision	08
------------------	----

## Insulation characteristics

Protection class	III (VDE 0106, IEC 60536)
------------------	---------------------------

## Switch functions

Basic functions	Store and forward switch, Extended Ring and IEEE redundancy, Multicast control, IGMP snooping, trunking, Port and Tagging VLANs, Port and IEEE 802.1x security, SNMP V3 and Https security, SNTP, web customization, user accounts
Signal contact control voltage	24 V DC
Signal contact control current	100 mA
Redundancy	ERR (Extended ring redundancy)
Status and diagnostic indicators	LEDs: U <sub>S1</sub> , U <sub>S2</sub> (redundant voltage supply), link and activity per port

## Security functions

Basic functions	Store and forward switch, Extended Ring and IEEE redundancy, Multicast control, IGMP snooping, trunking, Port and Tagging VLANs, Port and IEEE 802.1x security, SNMP V3 and Https security, SNTP, web customization, user accounts
-----------------	--

## Electrical properties

Local diagnostics	US1, US2 Supply voltage Green LED
	LNK/ACT Link status/data transmission Green LED
	100 Data transmission speed Red LED
Maximum power dissipation for nominal condition	5.04 W
Test section	Supply voltage/functional ground 500 V 1 min.
Transmission medium	Copper

## Supply

Supply voltage (DC)	24 V DC (redundant)
Supply voltage range	12 V DC ... 48 V DC
Inrush current	4.96 A (3.2 ms)
Residual ripple	3.6 V <sub>PP</sub> (within the permitted voltage range)
Typical current consumption	206 mA (at U <sub>S</sub> = 24 V DC)

## Function

Signal contact control voltage	24 V DC
Signal contact control current	100 mA

## Connection data

### Connection technology

Connection name	Power supply
pluggable	yes

### Power supply

Connection method	Screw connection
-------------------	------------------

# FL SWITCH 3008 - Industrial Ethernet Switch



2891031

<https://www.phoenixcontact.com/in/products/2891031>

Conductor cross section, rigid	0.2 mm <sup>2</sup> ... 2.5 mm <sup>2</sup>
Conductor cross section, flexible	0.2 mm <sup>2</sup> ... 2.5 mm <sup>2</sup>
Conductor cross section AWG	24 ... 12
Stripping length	7 mm

## Environmental and real-life conditions

### Ambient conditions

Degree of protection	IP20
Ambient temperature (operation)	-10 °C ... 60 °C
Ambient temperature (storage/transport)	-20 °C ... 85 °C
Permissible humidity (operation)	5 % ... 95 % (non-condensing)
Permissible humidity (storage/transport)	5 % ... 95 % (non-condensing)
Air pressure (operation)	57 kPa ... 108 kPa (up to 4850 m above mean sea level)
Air pressure (storage/transport)	57 kPa ... 108 kPa (up to 4850 m above mean sea level)

## EMC data

Conformance with EMC directives	IEC 61000-6-2 IEC 61000-4-2 (ESD) Criterion B
	IEC 61000-4-3 (immunity to radiated interference) Criterion A
	IEC 61000-4-4 (burst) Criterion A
	IEC 61000-4-5 (surge) Criterion B
	IEC 61000-4-6 (immunity to conducted interference) Criterion A
	IEC 61000-4-8 (immunity to magnetic fields) Criterion A
	EN 55022 (emitted interference) Class A
NEMA TS-2	
Noise immunity	EN 61000-6-2:2005
Noise emission	EN 61000-6-4

## System properties

### Functionality

Basic functions	Store and forward switch, Extended Ring and IEEE redundancy, Multicast control, IGMP snooping, trunking, Port and Tagging VLANs, Port and IEEE 802.1x security, SNMP V3 and Https security, SNTp, web customization, user accounts
-----------------	--

## Signaling

Status display	LEDs: U <sub>S1</sub> , U <sub>S2</sub> (redundant voltage supply), link and activity per port
----------------	--

# FL SWITCH 3008 - Industrial Ethernet Switch



2891031

<https://www.phoenixcontact.com/in/products/2891031>

## Drawings

Dimensional drawing

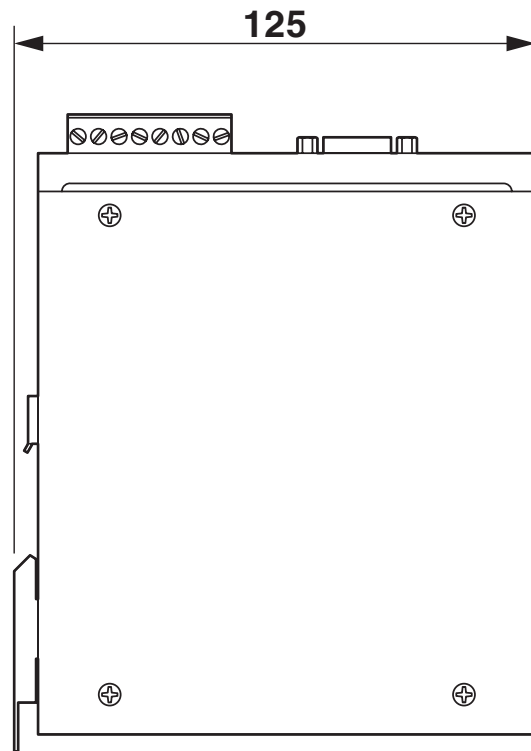
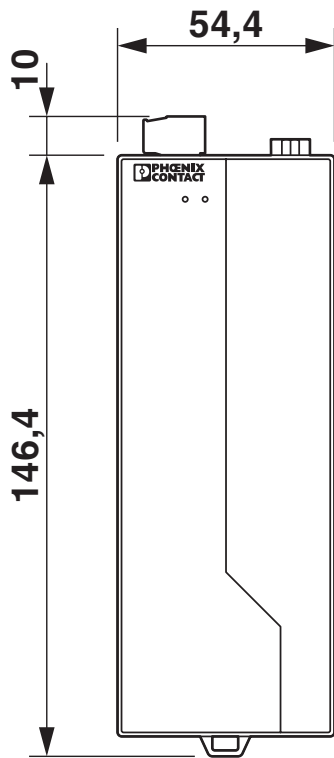

# FL SWITCH 3008 - Industrial Ethernet Switch





2891031

<https://www.phoenixcontact.com/in/products/2891031>

## Approvals

To download certificates, visit the product detail page: <https://www.phoenixcontact.com/in/products/2891031>

 **UL Listed**  
Approval ID: E140324

 **cUL Listed**  
Approval ID: E140324

 **cUL Listed**  
Approval ID: E238705

 **UL Listed**  
Approval ID: E238705

 **cUL Listed**  
Approval ID: File E 360692

 **UL Listed**  
Approval ID: File E 360692

 **UL Listed**  
Approval ID: E196811

 **cUL Listed**  
Approval ID: E196811

# FL SWITCH 3008 - Industrial Ethernet Switch



2891031

<https://www.phoenixcontact.com/in/products/2891031>

## Classifications

### ECLASS

ECLASS-11.0	19170401
ECLASS-12.0	19170401
ECLASS-13.0	19170401

### ETIM

ETIM 9.0	EC000734
----------	----------

### UNSPSC

UNSPSC 21.0	43222600
-------------	----------

# FL SWITCH 3008 - Industrial Ethernet Switch



2891031

<https://www.phoenixcontact.com/in/products/2891031>

## Environmental product compliance

### EU RoHS

Fulfills EU RoHS substance requirements	Yes
Exemption	6(c), 7(a), 7(c)-I

### China RoHS

Environment friendly use period (EFUP)	EFUP-10
	An article-related China RoHS declaration table can be found in the download area for the respective article under "Manufacturer declaration". For all articles with EFUP-E, no China RoHS declaration table issued and required.

### EU REACH SVHC

REACH candidate substance (CAS No.)	Lead(CAS: 7439-92-1)
SCIP	66c2da69-38eb-4517-9088-7494145fe2d7

Phoenix Contact 2024 © - all rights reserved

<https://www.phoenixcontact.com>

PHOENIX CONTACT (I) Pvt. Ltd.

A-58/2, Okhla Industrial Area, Phase - II, New Delhi-110 020

+91.1275.71420

[info@phoenixcontact.co.in](mailto:info@phoenixcontact.co.in)