

QUINT-PS/24DC/12DC/ 8 - DC/DC converters



2320115

<https://www.phoenixcontact.com/in/products/2320115>

Please be informed that the data shown in this PDF document is generated from our Online Catalog. Please find the complete data in the user documentation. Our General Terms of Use for Downloads are valid.



Primary-switched QUINT DC/DC converter for DIN rail mounting with SFB (Selective Fuse Breaking) Technology, input: 24 V DC, output: 12 V DC/8 A

Product Description

QUINT DC/DC converter with maximum functionality

DC/DC converters alter the voltage level, regenerate the voltage at the end of long cables or enable the creation of independent supply systems by means of electrical isolation.

QUINT DC/DC converters magnetically and therefore quickly trip circuit breakers with six times the nominal current, for selective and therefore cost-effective system protection. The high level of system availability is additionally ensured, thanks to preventive function monitoring, as it reports critical operating states before errors occur.

Your advantages

- Reliable starting of difficult loads, thanks to the static POWER BOOST power reserve with up to 125% nominal current permanently
- Preventive function monitoring indicates critical operating states before errors occur
- Constant voltage: output voltage regenerated even at the end of long cables
- Support conversion to various voltage levels
- Electrical isolation: for setting up independent supply systems

Commercial Data

Item number	2320115
Packing unit	1 pc
Minimum order quantity	1 pc
Sales Key	CMD
Product Key	CMDQ42
Catalog Page	Page 249 (C-4-2017)
GTIN	4046356482233
Weight per Piece (including packing)	868.2 g
Weight per Piece (excluding packing)	853 g
Customs tariff number	85044083
Country of origin	IN

Technical Data

Input data

DC operation

Nominal input voltage range	24 V DC
Input voltage range	18 V DC ... 32 V DC
Extended input voltage range in operation	14 V DC ... 18 V DC (Consider derating during operation)
Wide-range input	no
Input voltage range DC	18 V DC ... 32 V DC 14 V DC ... 18 V DC (Consider derating during operation)
Voltage type of supply voltage	DC
Inrush current	< 15 A (typical)
Inrush current integral (I^2t)	< 0.5 A ² s
Mains buffering time	> 10 ms (24 V DC)
Current consumption	6 A (24 V, I_{BOOST})
Reverse polarity protection	≤ yes30 V DC
Protective circuit	Transient surge protection; Varistor
Input fuse	15 A (internal (device protection))

Output data

Efficiency	> 90 %
Output characteristic	U/I
Nominal output voltage	12 V DC ±1 %
Setting range of the output voltage (U_{Set})	5 V DC ... 18 V DC (> 12 V DC, constant capacity restricted)
Nominal output current (I_N)	8 A (-25 °C ... 60 °C)
POWER BOOST (I_{Boost})	10 A (-25 °C ... 40 °C permanent, $U_{OUT} = 12$ V DC)
Selective Fuse Breaking (I_{SFB})	48 A (12 ms)
Magnetic circuit breaker tripping	B2 / B4 / C2
Derating	60 °C ... 70 °C (2.5%/K)
Feedback voltage resistance	25 V DC
Protection against overvoltage at the output (OVP)	< 25 V DC
Max. capacitive load	unlimited
Active current limitation	15 A
Control deviation	< 1 % (change in load, static 10 % ... 90 %) < 2 % (change in load, dynamic 10 % ... 90 %) < 0.1 % (change in input voltage ±10 %)
Residual ripple	< 20 mV _{PP}
Output power	96 W
Peak switching voltages nominal load	< 10 mV _{PP} (20 MHz)
Maximum no-load power dissipation	2 W
Power loss nominal load max.	10.5 W
Rise time	< 2 ms (U_{OUT} (10 % ... 90 %))
Connection in parallel	yes, for redundancy and increased capacity

QUINT-PS/24DC/12DC/ 8 - DC/DC converters



2320115

<https://www.phoenixcontact.com/in/products/2320115>

Connection in series	yes
----------------------	-----

Signal: DC OK active

Output description	$U_{OUT} > 0.9 \times U_N$: High signal
Switching voltage range	12 V DC
Maximum inrush current	< 20 mA (short-circuit-proof)

Signal: POWER BOOST, active

Output description	$I_{OUT} < I_N$: High signal
Switching voltage range	12 V DC
Maximum inrush current	< 20 mA (short-circuit-proof)

Signal: U_{IN} OK, active

Output description	$U_{IN} > 19.2$ V: High signal
Switching voltage range	12 V DC
Maximum inrush current	≤ 20 mA (short-circuit-proof)

Connection data

Input

Connection method	Pluggable screw connection
Conductor cross section, rigid min.	0.2 mm ²
Conductor cross section, rigid max.	2.5 mm ²
Conductor cross section flexible min.	0.2 mm ²
Conductor cross section flexible max.	2.5 mm ²
Conductor cross section AWG min.	24
Conductor cross section AWG max.	12
Stripping length	8 mm
Screw thread	M3
Tightening torque, min	0.5 Nm
Tightening torque max	0.6 Nm

Output

Connection method	Pluggable screw connection
Conductor cross section, rigid min.	0.2 mm ²
Conductor cross section, rigid max.	2.5 mm ²
Conductor cross section flexible min.	0.2 mm ²
Conductor cross section flexible max.	2.5 mm ²
Conductor cross section AWG min.	24
Conductor cross section AWG max.	12
Stripping length	7 mm
Screw thread	M3
Tightening torque, min	0.5 Nm
Tightening torque max	0.6 Nm

Signal

Conductor cross section, rigid min.	0.2 mm ²
-------------------------------------	---------------------

QUINT-PS/24DC/12DC/ 8 - DC/DC converters



2320115

<https://www.phoenixcontact.com/in/products/2320115>

Conductor cross section, rigid max.	2.5 mm ²
Conductor cross section flexible min.	0.2 mm ²
Conductor cross section flexible max.	2.5 mm ²
Conductor cross section AWG min.	24
Conductor cross section AWG max.	12
Screw thread	M3
Tightening torque, min	0.5 Nm
Tightening torque max	0.6 Nm

Signaling

Types of signaling	LED
	Active switching output
	Relay contact

Signal output: DC OK active

Status display	"DC OK" LED green
Color	green

Signal output: POWER BOOST, active

Status display	"BOOST" LED yellow/ $I_{OUT} > I_N$: LED on
Color	yellow
Note on status display	LED on

Signal output: U_{IN} OK, active

Status display	LED " $U_{IN} < 19.2$ V" yellow/ $U_{IN} < 19.2$ V DC: LED on
Color	yellow
Note on status display	LED on

Electrical properties

Number of phases	1.00
Insulation voltage input/output	1.5 kV (type test)
	1 kV (routine test)
	1 kV (type test)

Product properties

Product type	DC/DC converters
MTBF (IEC 61709, SN 29500)	> 843000 h (40 °C)

Insulation characteristics

Protection class	III
Degree of pollution	2

Dimensions

Width	32 mm
Height	130 mm
Depth	125 mm

2320115

<https://www.phoenixcontact.com/in/products/2320115>

Installation dimensions

Installation distance right/left	0 mm / 0 mm ($\leq 70\text{ °C}$)
Installation distance right/left (active)	15 mm / 15 mm ($\leq 70\text{ °C}$)
Installation distance top/bottom	50 mm / 50 mm ($\leq 70\text{ °C}$)
Installation distance top/bottom (active)	50 mm / 50 mm ($\leq 70\text{ °C}$)

Alternative assembly

Width	122 mm
Height	130 mm
Depth	35 mm

Mounting

Mounting type	DIN rail mounting
Assembly instructions	alignable: $P_N \geq 50\%$, 5 mm horizontally, 15 mm next to active components, 50 mm vertically alignable: $P_N < 50\%$, 0 mm horizontally, 40 mm vertically top, 20 mm vertically bottom
Mounting position	horizontal DIN rail NS 35, EN 60715
With protective coating	No

Material specifications

Color	aluminium
Housing material	Metal
Type of housing	Aluminum (AIMg3)
Hood version	Galvanized sheet steel, free from chrome (VI)

Environmental and real-life conditions

Ambient conditions

Degree of protection	IP20
Ambient temperature (operation)	$-25\text{ °C} \dots 70\text{ °C}$ ($> 60\text{ °C}$ derating, 2.5 %/K, startup at -40 °C type-tested)
Ambient temperature (storage/transport)	$-40\text{ °C} \dots 85\text{ °C}$
Ambient temperature (start-up type tested)	-40 °C
Climatic class	3K3 (in acc. with EN 60721)
Max. permissible relative humidity (operation)	$\leq 95\%$ (at 25 °C , non-condensing)
Shock	18 ms, 30g, in each space direction (according to IEC 60068-2-27)
Vibration (operation)	$< 15\text{ Hz}$, amplitude $\pm 2.5\text{ mm}$ (according to IEC 60068-2-6) $15\text{ Hz} \dots 150\text{ Hz}$, 2.3g, 90 min.

Standards and regulations

Rail applications	EN 50121-4
Standard – Electronic equipment for use in electrical power installations and their assembly into electrical power installations	EN 50178/VDE 0160 (PELV)
Standard - Electrical safety	EN 60950-1/VDE 0805 (SELV)
Standard – Safety extra-low voltage	EN 60950-1 (SELV)

QUINT-PS/24DC/12DC/ 8 - DC/DC converters



2320115

<https://www.phoenixcontact.com/in/products/2320115>

	EN 60204 (PELV)
Standard - Safe isolation	DIN VDE 0100-410

Approvals

Shipbuilding approval	DNV GL (EMC B)
UL approvals	UL/C-UL listed UL 508
	UL/C-UL Recognized UL 60950-1
	UL ANSI/ISA-12.12.01 Class I, Division 2, Groups A, B, C, D (Hazardous Location)

EMC data

EMC requirements for noise emission	EN 61000-6-3
	EN 61000-6-4
EMC requirements for noise immunity	EN 61000-6-1
	EN 61000-6-2
Electromagnetic compatibility	Conformance with EMC Directive 2014/30/EU

Electrostatic discharge

Standards/regulations	EN 61000-4-2
-----------------------	--------------

Electrostatic discharge

Contact discharge	8 kV (Test Level 4)
Discharge in air	15 kV (Test Level 4)
Comments	Criterion A

Electromagnetic HF field

Standards/regulations	EN 61000-4-3
-----------------------	--------------

Electromagnetic HF field

Frequency range	80 MHz ... 1 GHz
Test field strength	10 V/m
Frequency range	1 GHz ... 2 GHz
Test field strength	10 V/m
Frequency range	2 GHz ... 3 GHz
Test field strength	10 V/m
Comments	Criterion A

Fast transients (burst)

Standards/regulations	EN 61000-4-4
-----------------------	--------------

Fast transients (burst)

Input	2 kV (Test Level 3 - asymmetrical)
Output	2 kV (Test Level 3 - asymmetrical)
Signal	2 kV (Test Level 4 - asymmetrical)
Comments	Criterion A

Surge voltage load (surge)

Standards/regulations	EN 61000-4-5
-----------------------	--------------

QUINT-PS/24DC/12DC/ 8 - DC/DC converters



2320115

<https://www.phoenixcontact.com/in/products/2320115>

Input	1 kV (Test Level 2 - symmetrical)
	2 kV (Test Level 3 - asymmetrical)
Output	1 kV (Test Level 2 - symmetrical)
	2 kV (Test Level 3 - asymmetrical)
Signal	1 kV (Test Level 2 - asymmetrical)
Comments	Criterion A

Conducted interference

Standards/regulations	EN 61000-4-6
-----------------------	--------------

Conducted interference

I/O/S	asymmetrical
Frequency range	0.15 MHz ... 80 MHz
Comments	Criterion A
Voltage	10 V (Test Level 3)

Emitted interference

Standards/regulations	EN 61000-6-3
Radio interference voltage in acc. with EN 55011	EN 55011 (EN 55022) Class B, area of application: Industry and residential
Emitted radio interference in acc. with EN 55011	EN 55011 (EN 55022) Class B, area of application: Industry and residential

Criteria

Criterion A	Normal operating behavior within the specified limits.
Criterion B	Temporary impairment to operational behavior that is corrected by the device itself.

QUINT-PS/24DC/12DC/ 8 - DC/DC converters



2320115

<https://www.phoenixcontact.com/in/products/2320115>

Drawings

Block diagram

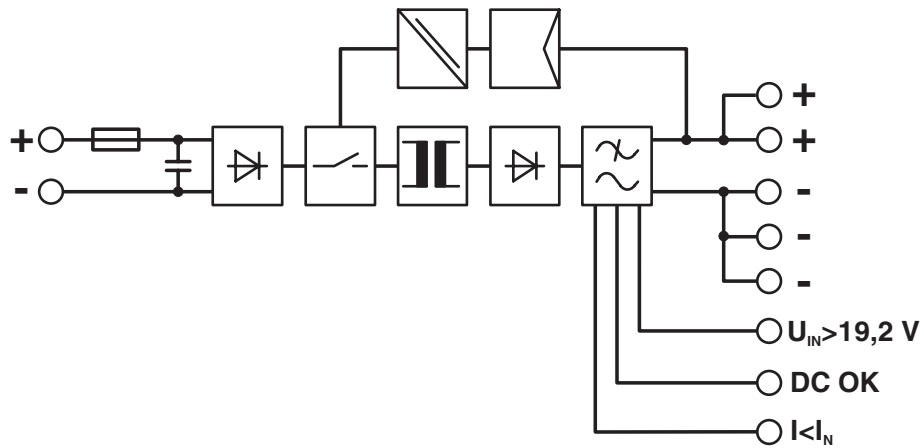

QUINT-PS/24DC/12DC/ 8 - DC/DC converters



2320115

<https://www.phoenixcontact.com/in/products/2320115>

Approvals



cUL Recognized
Approval ID: FILE E 211944



UL Recognized
Approval ID: FILE E 211944



IECEE CB Scheme
Approval ID: DK-5535-M1



EAC
Approval ID: EAC-Zulassung



NK
Approval ID: TA22564M



BV
Approval ID: 27662/B0 BV



EAC
Approval ID: RU S-DE.BL08.W.00764



UL Listed
Approval ID: FILE E 123528



cUL Listed
Approval ID: FILE E 123528



RINA
Approval ID: ELE333522XG



LR
Approval ID: LR22301698TA-02



cUL Listed
Approval ID: FILE E 199827

QUINT-PS/24DC/12DC/ 8 - DC/DC converters

2320115

<https://www.phoenixcontact.com/in/products/2320115>



UL Listed

Approval ID: FILE E 199827

QUINT-PS/24DC/12DC/ 8 - DC/DC converters



2320115

<https://www.phoenixcontact.com/in/products/2320115>

Classifications

ECLASS

ECLASS-11.0	27040701
ECLASS-13.0	27040701
ECLASS-12.0	27040701

ETIM

ETIM 8.0	EC002540
----------	----------

UNSPSC

UNSPSC 21.0	39121000
-------------	----------

QUINT-PS/24DC/12DC/ 8 - DC/DC converters



2320115

<https://www.phoenixcontact.com/in/products/2320115>

Environmental Product Compliance

REACH SVHC	Lead 7439-92-1
China RoHS	Environmentally Friendly Use Period = 25;
	For information on hazardous substances, refer to the manufacturer's declaration available under "Downloads"

QUINT-PS/24DC/12DC/ 8 - DC/DC converters



2320115

<https://www.phoenixcontact.com/in/products/2320115>

Accessories

QUINT-PS/1AC/24DC/10 - Power supply unit

2866763

<https://www.phoenixcontact.com/in/products/2866763>



Primary-switched power supply unit QUINT POWER, Screw connection, DIN rail mounting, SFB Technology (Selective Fuse Breaking), input: 1-phase, output: 24 V DC / 10 A

QUINT-PS/3AC/24DC/10 - Power supply unit

2866705

<https://www.phoenixcontact.com/in/products/2866705>



Primary-switched power supply unit QUINT POWER, Pluggable screw connection, SFB Technology (Selective Fuse Breaking), input: 3-phase, output: 24 V DC / 10 A

QUINT-PS/24DC/12DC/ 8 - DC/DC converters

2320115

<https://www.phoenixcontact.com/in/products/2320115>

TRIO-DIODE/12-24DC/2X10/1X20 - Redundancy module

2866514

<https://www.phoenixcontact.com/in/products/2866514>



Redundancy module with function monitoring, 12 ... 24 V DC, 2x 10 A, 1x 20 A

UTA 107/30 - Mounting adapter

2320089

<https://www.phoenixcontact.com/in/products/2320089>

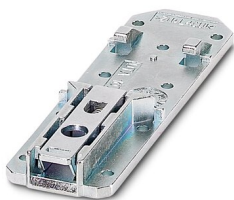

Universal DIN rail adapter

QUINT-PS/24DC/12DC/ 8 - DC/DC converters

2320115

<https://www.phoenixcontact.com/in/products/2320115>

UWA 182/52 - Mounting adapter

2938235

<https://www.phoenixcontact.com/in/products/2938235>



Universal wall adapter for securely mounting the device in the event of strong vibrations. The device is screwed directly onto the mounting surface. The universal wall adapter is attached on the top/bottom.

QUINT-PS-ADAPTERS7/1 - Mounting adapter

2938196

<https://www.phoenixcontact.com/in/products/2938196>



Assembly adapter for QUINT-PS... power supply on S7-300 rail

QUINT-PS/24DC/12DC/ 8 - DC/DC converters

2320115

<https://www.phoenixcontact.com/in/products/2320115>

CB TM1 1A SFB P - Thermomagnetic device circuit breaker

2800836

<https://www.phoenixcontact.com/in/products/2800836>



Thermomagnetic device circuit breaker, 1-pos., tripping characteristic SFB, 1 changeover contact, plug for base element.

CB TM1 2A SFB P - Thermomagnetic device circuit breaker

2800837

<https://www.phoenixcontact.com/in/products/2800837>



Thermomagnetic device circuit breaker, 1-pos., tripping characteristic SFB, 1 changeover contact, plug for base element.

QUINT-PS/24DC/12DC/ 8 - DC/DC converters

2320115

<https://www.phoenixcontact.com/in/products/2320115>

CB TM1 3A SFB P - Thermomagnetic device circuit breaker

2800838

<https://www.phoenixcontact.com/in/products/2800838>



Thermomagnetic device circuit breaker, 1-pos., tripping characteristic SFB, 1 changeover contact, plug for base element.

CB TM1 4A SFB P - Thermomagnetic device circuit breaker

2800839

<https://www.phoenixcontact.com/in/products/2800839>



Thermomagnetic device circuit breaker, 1-pos., tripping characteristic SFB, 1 changeover contact, plug for base element.

QUINT-PS/24DC/12DC/ 8 - DC/DC converters



2320115

<https://www.phoenixcontact.com/in/products/2320115>

CB TM1 12A SFB P - Thermomagnetic device circuit breaker

2800844

<https://www.phoenixcontact.com/in/products/2800844>



Thermomagnetic device circuit breaker, 1-pos., tripping characteristic SFB, 1 changeover contact, plug for base element.

CB TM1 16A SFB P - Thermomagnetic device circuit breaker

2800845

<https://www.phoenixcontact.com/in/products/2800845>



Thermomagnetic device circuit breaker, 1-pos., tripping characteristic SFB, 1 changeover contact, plug for base element.

Phoenix Contact 2023 © - all rights reserved
<https://www.phoenixcontact.com>

PHOENIX CONTACT (I) Pvt. Ltd.
A-58/2, Okhla Industrial Area, Phase - II, New Delhi-110 020

+91.1275.71420
info@phoenixcontact.co.in