

IGBT Power Module

- Power module
- 3-phase full-bridge
- Including fast free-wheel diodes
- Package with insulated metal base plate

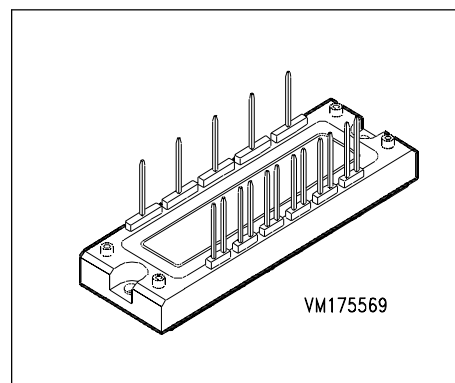

Type	V_{CE}	I_C	Package	Ordering Code
BSM 25 GD 120 DN2	1200V	35A	ECONOPACK 2	C67076-A2505-A67
BSM 25 GD120DN2E3224	1200V	35A	ECONOPACK 2K	C67070-A2505-A67

Maximum Ratings

Parameter	Symbol	Values	Unit
Collector-emitter voltage	V_{CE}	1200	V
Collector-gate voltage $R_{GE} = 20 \text{ k}\Omega$	V_{CGR}	1200	
Gate-emitter voltage	V_{GE}	± 20	
DC collector current $T_C = 25 \text{ }^\circ\text{C}$ $T_C = 80 \text{ }^\circ\text{C}$	I_C	35 25	A
Pulsed collector current, $t_p = 1 \text{ ms}$ $T_C = 25 \text{ }^\circ\text{C}$ $T_C = 80 \text{ }^\circ\text{C}$	I_{Cpuls}	70 50	
Power dissipation per IGBT $T_C = 25 \text{ }^\circ\text{C}$	P_{tot}	200	W
Chip temperature	T_j	+ 150	$^\circ\text{C}$
Storage temperature	T_{stg}	-40 ... + 125	
Thermal resistance, chip case	R_{thJC}	≤ 0.6	K/W
Diode thermal resistance, chip case	R_{thJCD}	≤ 1	
Insulation test voltage, $t = 1 \text{ min.}$	V_{is}	2500	Vac
Creepage distance	-	16	mm
Clearance	-	11	
DIN humidity category, DIN 40 040	-	F	sec
IEC climatic category, DIN IEC 68-1	-	40 / 125 / 56	

Electrical Characteristics, at $T_j = 25\text{ °C}$, unless otherwise specified

Parameter	Symbol	Values			Unit
		min.	typ.	max.	

Static Characteristics

Gate threshold voltage $V_{GE} = V_{CE}, I_C = 1\text{ mA}$	$V_{GE(th)}$	4.5	5.5	6.5	V
Collector-emitter saturation voltage $V_{GE} = 15\text{ V}, I_C = 25\text{ A}, T_j = 25\text{ °C}$ $V_{GE} = 15\text{ V}, I_C = 25\text{ A}, T_j = 125\text{ °C}$	$V_{CE(sat)}$	- -	2.5 3.1	3 3.7	
Zero gate voltage collector current $V_{CE} = 1200\text{ V}, V_{GE} = 0\text{ V}, T_j = 25\text{ °C}$ $V_{CE} = 1200\text{ V}, V_{GE} = 0\text{ V}, T_j = 125\text{ °C}$	I_{CES}	- -	0.5 2	0.8 -	mA
Gate-emitter leakage current $V_{GE} = 20\text{ V}, V_{CE} = 0\text{ V}$	I_{GES}	-	-	180	nA

AC Characteristics

Transconductance $V_{CE} = 20\text{ V}, I_C = 25\text{ A}$	g_{fs}	10	-	-	S
Input capacitance $V_{CE} = 25\text{ V}, V_{GE} = 0\text{ V}, f = 1\text{ MHz}$	C_{iss}	-	1650	-	pF
Output capacitance $V_{CE} = 25\text{ V}, V_{GE} = 0\text{ V}, f = 1\text{ MHz}$	C_{oss}	-	250	-	
Reverse transfer capacitance $V_{CE} = 25\text{ V}, V_{GE} = 0\text{ V}, f = 1\text{ MHz}$	C_{rss}	-	110	-	

Electrical Characteristics, at $T_j = 25\text{ °C}$, unless otherwise specified

Parameter	Symbol	Values			Unit
		min.	typ.	max.	

Switching Characteristics, Inductive Load at $T_j = 125\text{ °C}$

Turn-on delay time $V_{CC} = 600\text{ V}$, $V_{GE} = 15\text{ V}$, $I_C = 25\text{ A}$ $R_{Gon} = 47\ \Omega$	$t_{d(on)}$	-	75	150	ns
Rise time $V_{CC} = 600\text{ V}$, $V_{GE} = 15\text{ V}$, $I_C = 25\text{ A}$ $R_{Gon} = 47\ \Omega$	t_r	-	65	130	
Turn-off delay time $V_{CC} = 600\text{ V}$, $V_{GE} = -15\text{ V}$, $I_C = 25\text{ A}$ $R_{Goff} = 47\ \Omega$	$t_{d(off)}$	-	400	600	
Fall time $V_{CC} = 600\text{ V}$, $V_{GE} = -15\text{ V}$, $I_C = 25\text{ A}$ $R_{Goff} = 47\ \Omega$	t_f	-	50	100	

Free-Wheel Diode

Diode forward voltage $I_F = 25\text{ A}$, $V_{GE} = 0\text{ V}$, $T_j = 25\text{ °C}$ $I_F = 25\text{ A}$, $V_{GE} = 0\text{ V}$, $T_j = 125\text{ °C}$	V_F	-	2.3	2.8	V
		-	1.8	-	
Reverse recovery time $I_F = 25\text{ A}$, $V_R = -600\text{ V}$, $V_{GE} = 0\text{ V}$ $di_F/dt = -800\text{ A}/\mu\text{s}$, $T_j = 125\text{ °C}$	t_{rr}	-	0.13	-	μs
Reverse recovery charge $I_F = 25\text{ A}$, $V_R = -600\text{ V}$, $V_{GE} = 0\text{ V}$ $di_F/dt = -800\text{ A}/\mu\text{s}$ $T_j = 25\text{ °C}$ $T_j = 125\text{ °C}$	Q_{rr}	-	2.3	-	μC
		-	6	-	

Power dissipation

$$P_{tot} = f(T_C)$$

parameter: $T_j \leq 150\text{ }^\circ\text{C}$

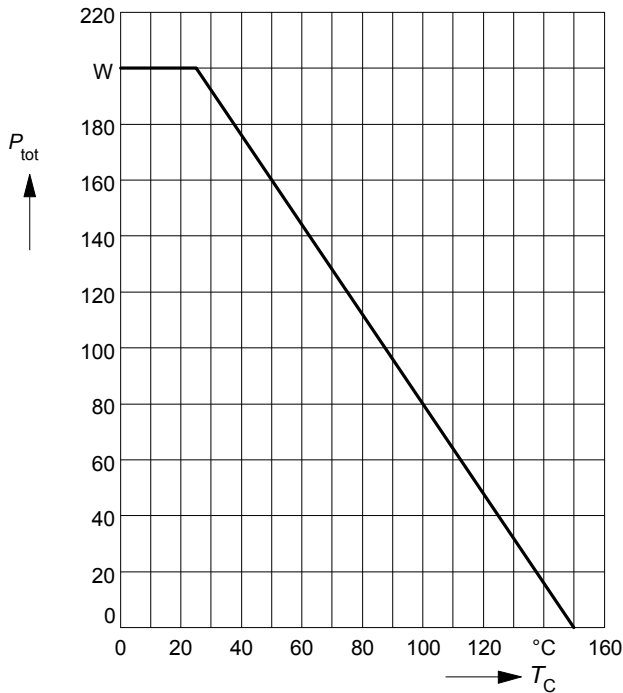

Safe operating area

$$I_C = f(V_{CE})$$

parameter: $D = 0, T_C = 25\text{ }^\circ\text{C}, T_j \leq 150\text{ }^\circ\text{C}$

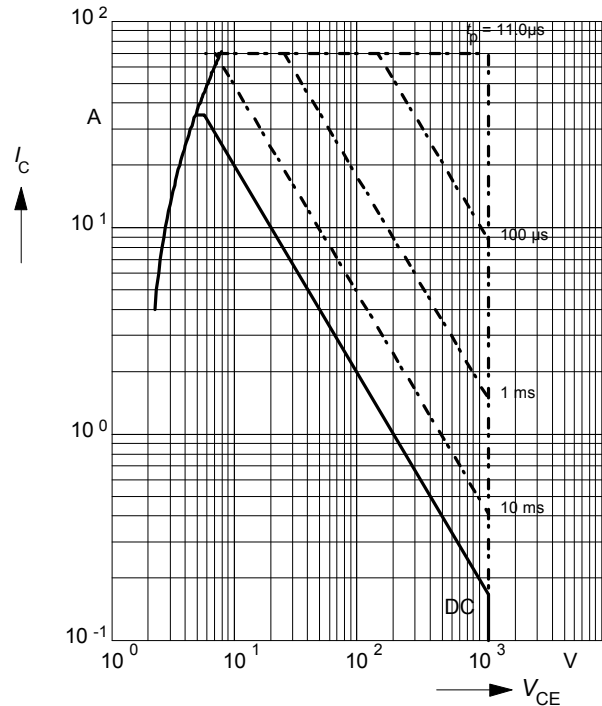

Collector current

$$I_C = f(T_C)$$

parameter: $V_{GE} \geq 15\text{ V}, T_j \leq 150\text{ }^\circ\text{C}$

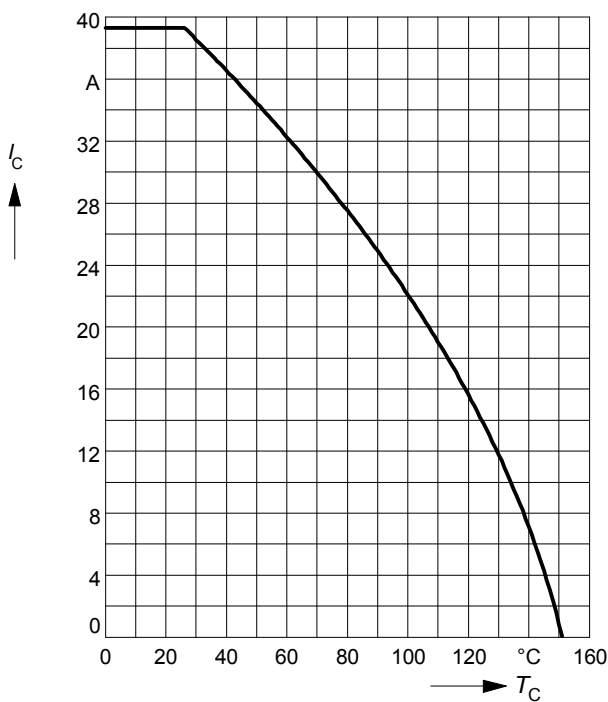

Transient thermal impedance IGBT

$$Z_{thJC} = f(t_p)$$

parameter: $D = t_p / T$

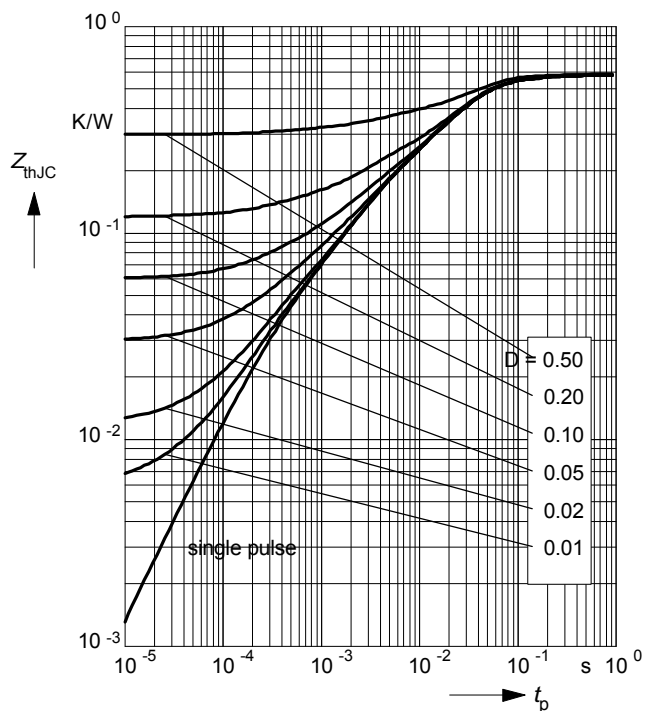

Typ. output characteristics

$I_C = f(V_{CE})$

parameter: $t_p = 80 \mu s, T_j = 25 \text{ }^\circ\text{C}$

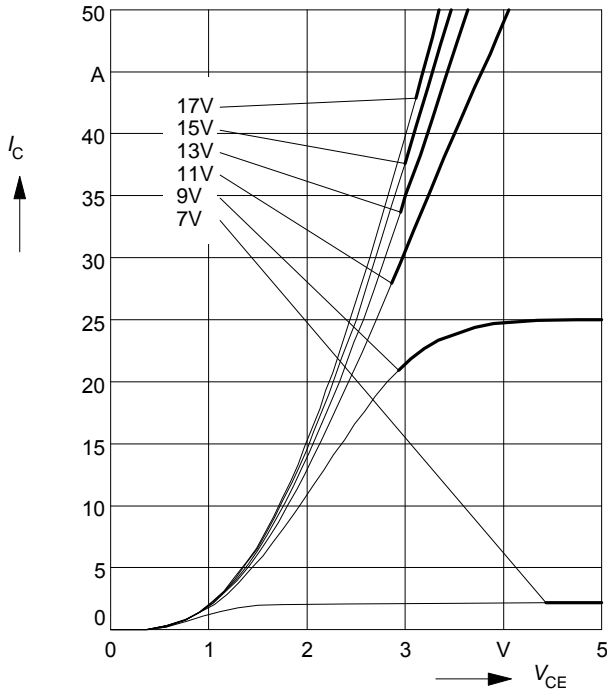

Typ. output characteristics

$I_C = f(V_{CE})$

parameter: $t_p = 80 \mu s, T_j = 125 \text{ }^\circ\text{C}$

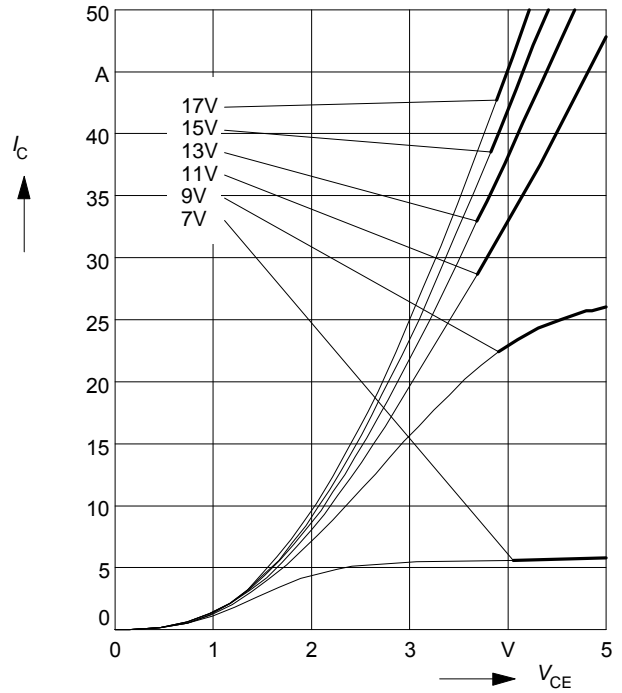

Typ. transfer characteristics

$I_C = f(V_{GE})$

parameter: $t_p = 80 \mu s, V_{CE} = 20 \text{ V}$

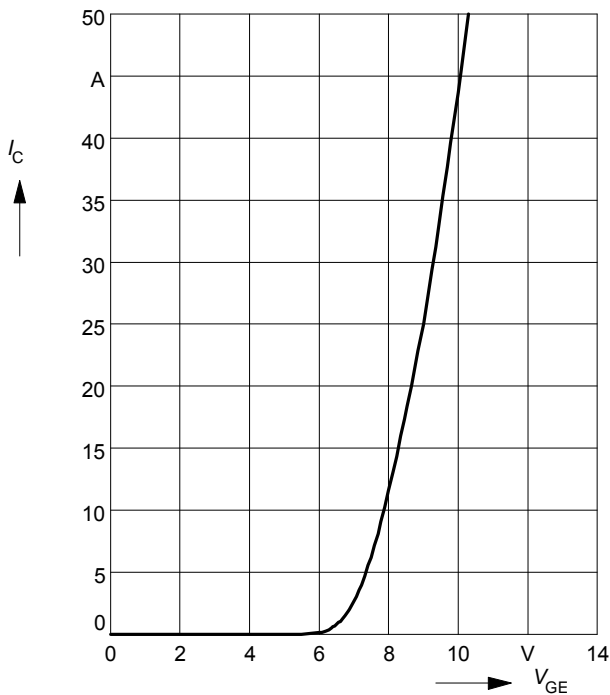

Typ. gate charge

$V_{GE} = f(Q_{Gate})$
 parameter: $I_{C\ puls} = 25\text{ A}$

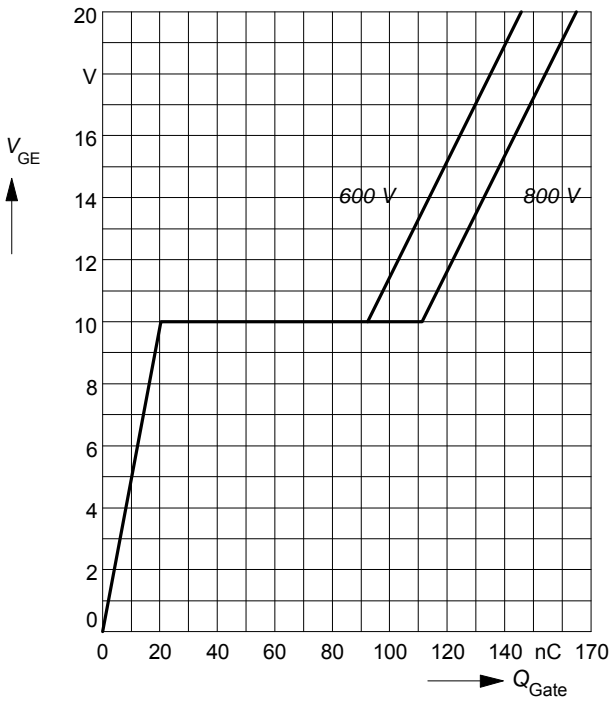

Typ. capacitances

$C = f(V_{CE})$
 parameter: $V_{GE} = 0\text{ V}, f = 1\text{ MHz}$

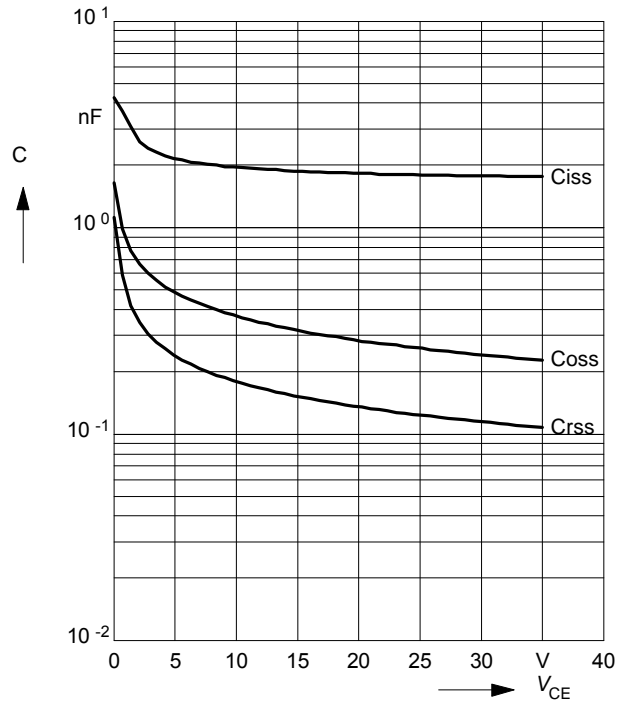

Reverse biased safe operating area

$I_{C\ puls} = f(V_{CE}), T_j = 150^\circ\text{C}$
 parameter: $V_{GE} = 15\text{ V}$

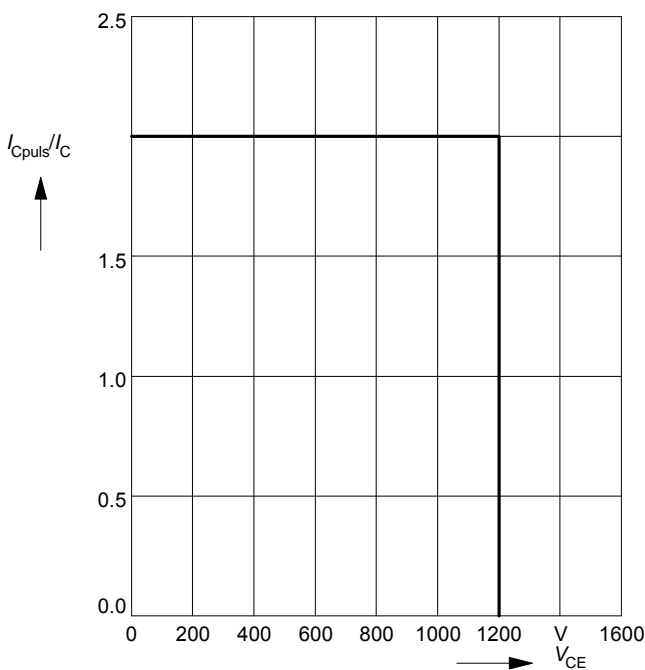

Short circuit safe operating area

$I_{C\ sc} = f(V_{CE}), T_j = 150^\circ\text{C}$
 parameter: $V_{GE} = \pm 15\text{ V}, t_{sc} \le 10\ \mu\text{s}, L < 50\text{ nH}$

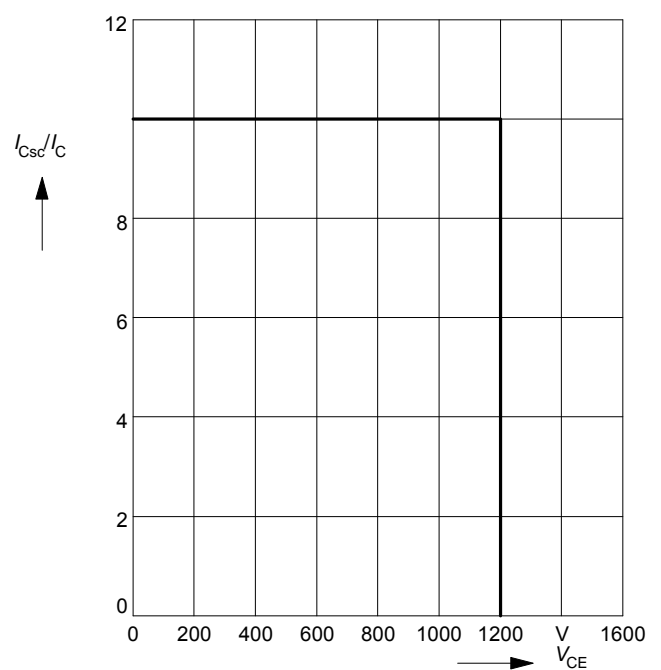

Typ. switching time

$t = f(I_C)$, inductive load, $T_j = 125^\circ\text{C}$
 par.: $V_{CE} = 600\text{ V}$, $V_{GE} = \pm 15\text{ V}$, $R_G = 47\ \Omega$

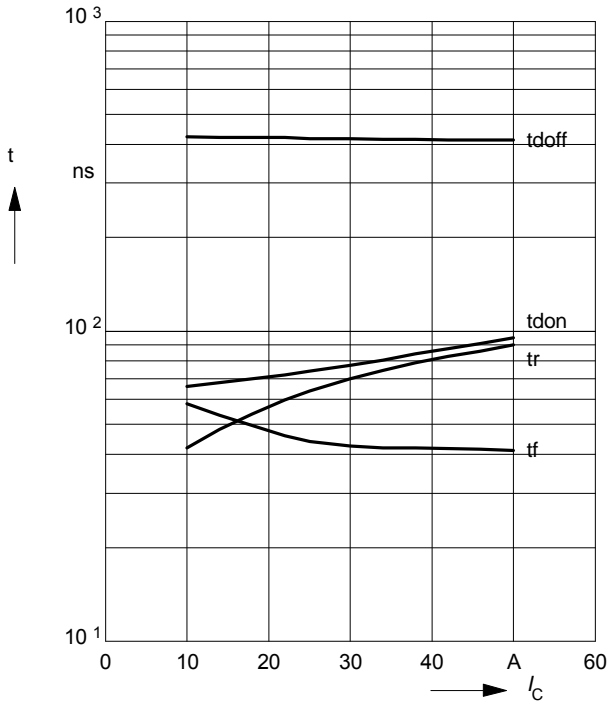

Typ. switching time

$t = f(R_G)$, inductive load, $T_j = 125^\circ\text{C}$
 par.: $V_{CE} = 600\text{ V}$, $V_{GE} = \pm 15\text{ V}$, $I_C = 25\text{ A}$

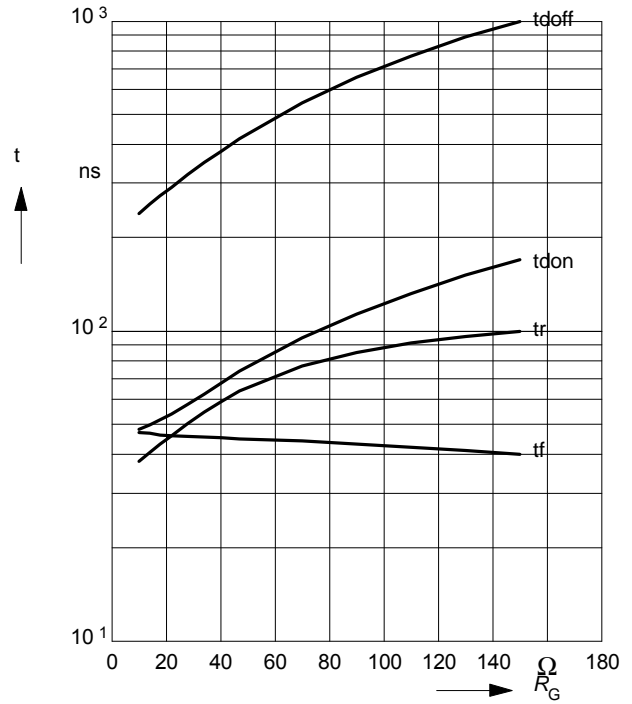

Typ. switching losses

$E = f(I_C)$, inductive load, $T_j = 125^\circ\text{C}$
 par.: $V_{CE} = 600\text{ V}$, $V_{GE} = \pm 15\text{ V}$, $R_G = 47\ \Omega$

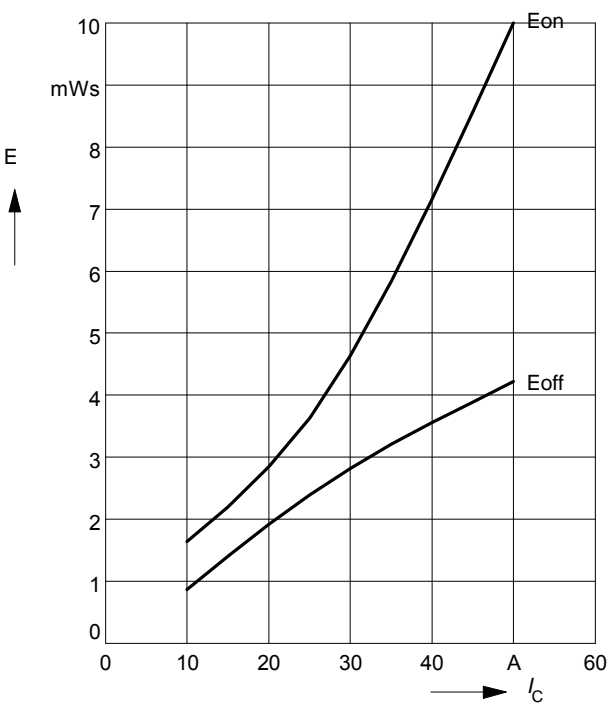

Typ. switching losses

$E = f(R_G)$, inductive load, $T_j = 125^\circ\text{C}$
 par.: $V_{CE} = 600\text{ V}$, $V_{GE} = \pm 15\text{ V}$, $I_C = 25\text{ A}$

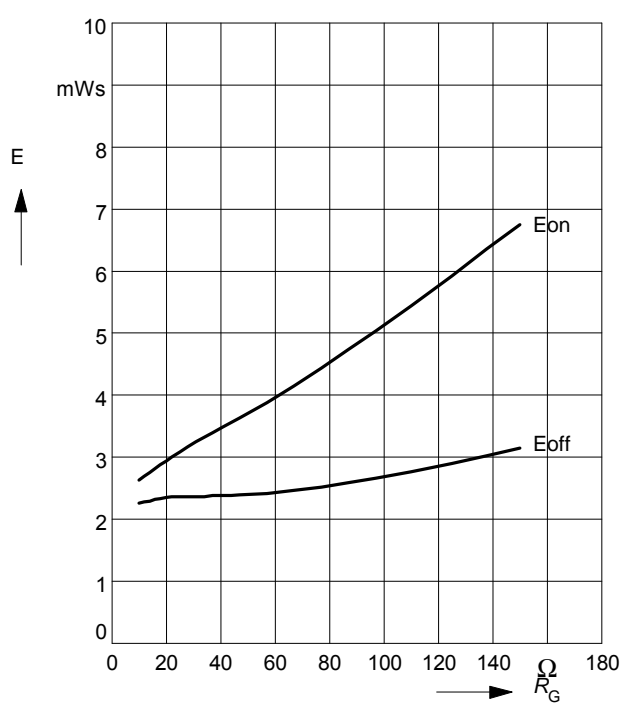

Forward characteristics of fast recovery reverse diode $I_F = f(V_F)$

parameter: T_j

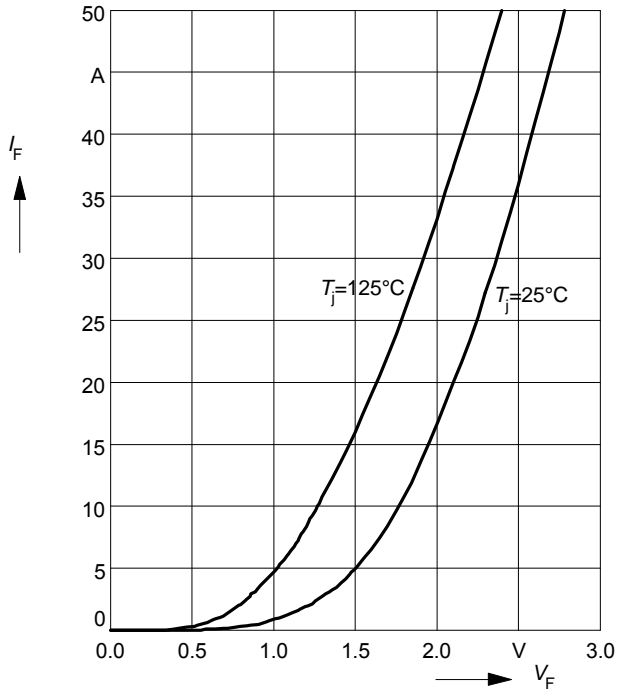

Transient thermal impedance Diode $Z_{thJC} = f(t_p)$

parameter: $D = t_p / T$

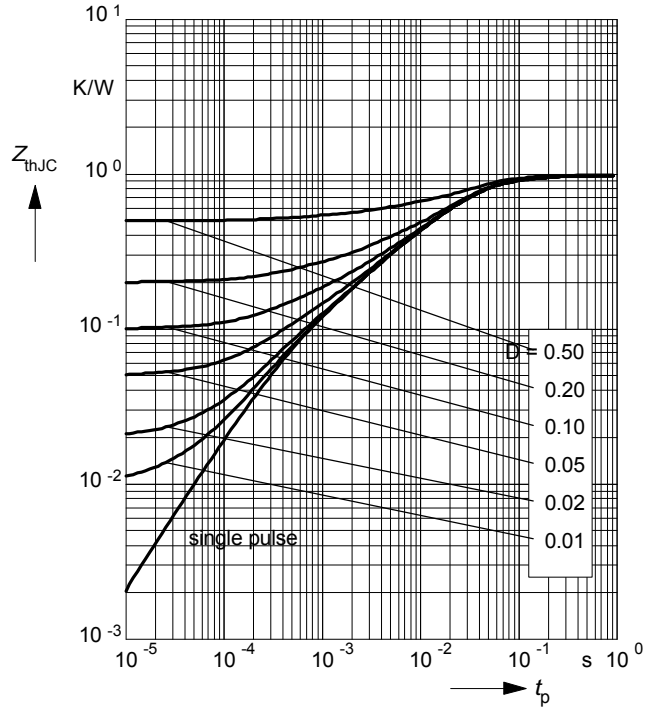

Gehäusemaße / Schaltbild
 Package outline / Circuit diagram

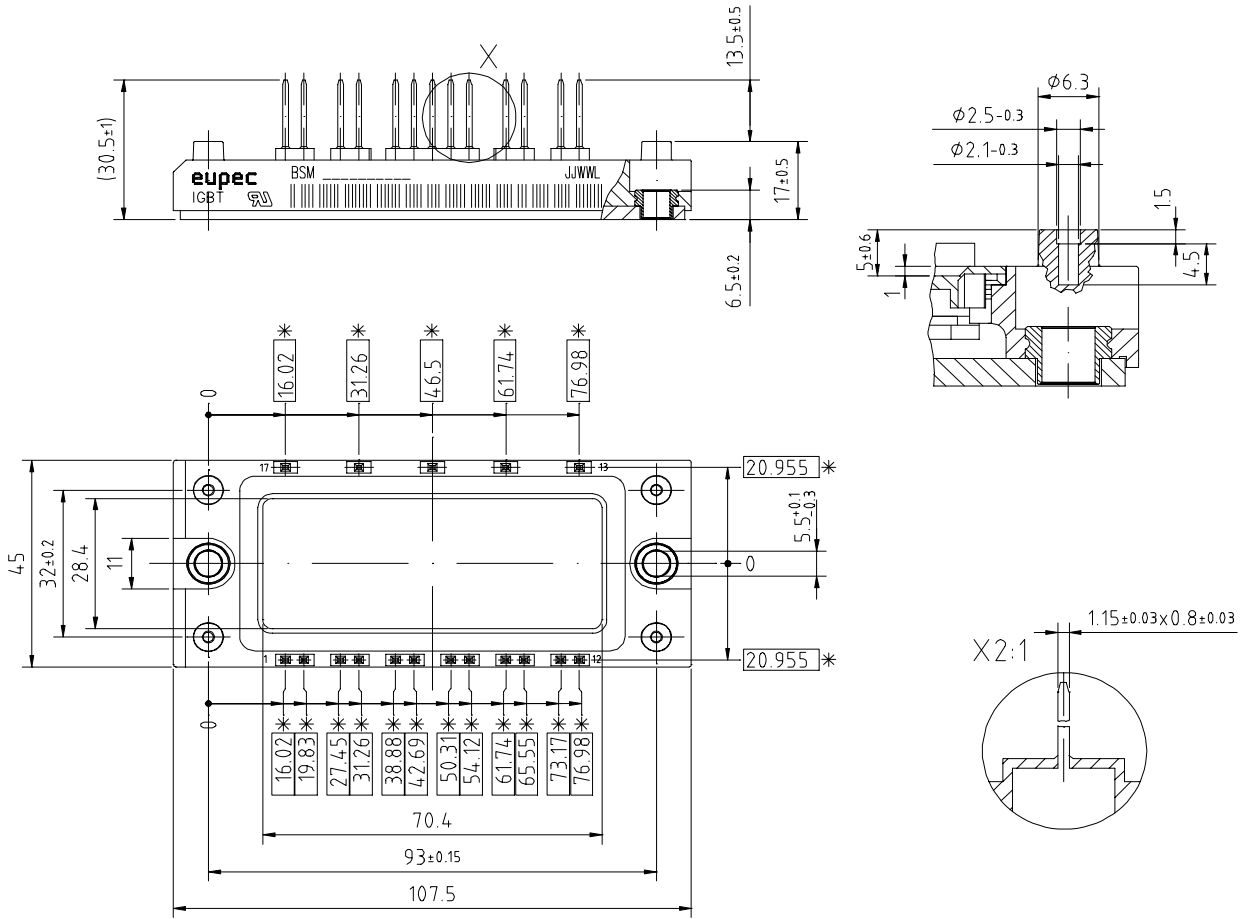

* = alle Maße mit einer Toleranz von $\pm \phi 0.4$
 * = all dimensions with a tolerance of $\pm \phi 0.4$

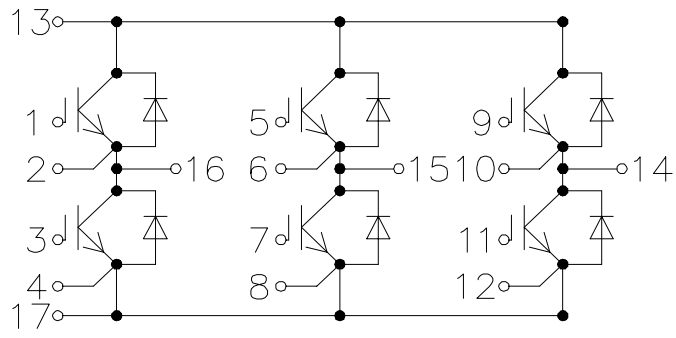

Nutzungsbedingungen

Die in diesem Produktdatenblatt enthaltenen Daten sind ausschließlich für technisch geschultes Fachpersonal bestimmt. Die Beurteilung der Geeignetheit dieses Produktes für die von Ihnen anvisierte Anwendung sowie die Beurteilung der Vollständigkeit der bereitgestellten Produktdaten für diese Anwendung obliegt Ihnen bzw. Ihren technischen Abteilungen.

In diesem Produktdatenblatt werden diejenigen Merkmale beschrieben, für die wir eine liefervertragliche Gewährleistung übernehmen. Eine solche Gewährleistung richtet sich ausschließlich nach Maßgabe der im jeweiligen Liefervertrag enthaltenen Bestimmungen. Garantien jeglicher Art werden für das Produkt und dessen Eigenschaften keinesfalls übernommen.

Sollten Sie von uns Produktinformationen benötigen, die über den Inhalt dieses Produktdatenblatts hinausgehen und insbesondere eine spezifische Verwendung und den Einsatz dieses Produktes betreffen, setzen Sie sich bitte mit dem für Sie zuständigen Vertriebsbüro in Verbindung (siehe www.eupec.com, Vertrieb&Kontakt). Für Interessenten halten wir Application Notes bereit.

Aufgrund der technischen Anforderungen könnte unser Produkt gesundheitsgefährdende Substanzen enthalten. Bei Rückfragen zu den in diesem Produkt jeweils enthaltenen Substanzen setzen Sie sich bitte ebenfalls mit dem für Sie zuständigen Vertriebsbüro in Verbindung.

Sollten Sie beabsichtigen, das Produkt in Anwendungen der Luftfahrt, in gesundheits- oder lebensgefährdenden oder lebenserhaltenden Anwendungsbereichen einzusetzen, bitten wir um Mitteilung. Wir weisen darauf hin, dass wir für diese Fälle

- die gemeinsame Durchführung eines Risiko- und Qualitätsassessments;
- den Abschluss von speziellen Qualitätssicherungsvereinbarungen;
- die gemeinsame Einführung von Maßnahmen zu einer laufenden Produktbeobachtung dringend empfehlen und gegebenenfalls die Belieferung von der Umsetzung solcher Maßnahmen abhängig machen.

Soweit erforderlich, bitten wir Sie, entsprechende Hinweise an Ihre Kunden zu geben.

Inhaltliche Änderungen dieses Produktdatenblatts bleiben vorbehalten.

Terms & Conditions of usage

The data contained in this product data sheet is exclusively intended for technically trained staff. You and your technical departments will have to evaluate the suitability of the product for the intended application and the completeness of the product data with respect to such application.

This product data sheet is describing the characteristics of this product for which a warranty is granted. Any such warranty is granted exclusively pursuant the terms and conditions of the supply agreement. There will be no guarantee of any kind for the product and its characteristics.

Should you require product information in excess of the data given in this product data sheet or which concerns the specific application of our product, please contact the sales office, which is responsible for you (see www.eupec.com, sales&contact). For those that are specifically interested we may provide application notes.

Due to technical requirements our product may contain dangerous substances. For information on the types in question please contact the sales office, which is responsible for you.

Should you intend to use the Product in aviation applications, in health or life endangering or life support applications, please notify.

Please note, that for any such applications we urgently recommend

- to perform joint Risk and Quality Assessments;
- the conclusion of Quality Agreements;
- to establish joint measures of an ongoing product survey, and that we may make delivery depended on the realization of any such measures.

If and to the extent necessary, please forward equivalent notices to your customers.

Changes of this product data sheet are reserved.