

12 W and 36 W Low profile Modular DC Power Supplies for electrical cabinets

Type 78.12....2400

- Output 24 V DC, 12 W
- 17.5 mm (1 module) x 61 mm deep

Type 78.12....1200

- Output 12 V DC, 12 W
- 17.5 mm (1 module) x 61 mm deep

Type 78.36

- Output 24 V DC, 36 W
- Input fuse: Easily replaceable plus spare
- 70 mm (4-module) wide x 61 mm deep
- Low (< 0.4 W) stand-by power consumption
- Thermal protection: internal, with V_{out} shutdown - power OFF to reset
- Short circuit protection: Hiccup (auto-recovery) mode
- Overvoltage protection: Varistor
- Flyback topology
- Compliant with EN 60950-1 and EN 61204-3
- Parallel working for automatic redundancy - with OR diodes
- Dual Polarity and Series connection permissible
- 35 mm rail (EN 60715) mount

Screw terminal



For outline drawing see page 17

Output specification

Output current (-20...+40 °C, 230 V AC input)	A	0.63	1.25	1.7
Rated current I _N (50 °C, full input operating range)	A	0.50	1	1.5
Rated voltage	V	24	12	24
Rated power	W	12	12	36
Output power (-20...+40 °C, 230 V AC input)	W	15	15	40
Peak current capability for 3 ms*	A	2	3	8
Output voltage adjust	V	—	—	—
Voltage variation (from no-load to full-load)		< 1%	< 1%	< 1%
Voltage ripple @ full load**	mV	< 200	< 200	< 200
Hold-up time @ full load:	with 100 V AC input	> 10	> 10	> 20
	with 260 V AC input	> 90	> 90	> 100

Input specification

Nominal voltage (U _N)	V AC (50/60 Hz)	110...240	110...240	110...240
	V DC (not polarized)	220	220	220
Operating range	V AC (50/60 Hz)	100...265***	100...265***	100...265***
	V DC	140...370	140...370	140...370
Max power consumption (@ 100 V AC, 50 Hz)	VA	28.2	32	57.5
	W	14.2	17.2	43
Stand-by power consumption	W	< 0.4	< 0.4	< 0.4
Power factor		0.50	0.53	0.74
Max current consumption (@ 88 V AC)	A	0.25	0.30	0.6
Max. inrush current (peak @ 265 V) for 3 ms	A	10	10	12
Replaceable input fuse		—	—	1 A - T

Technical data

Efficiency (@ 230 V AC)	%	85	87	86
MTTF	h	> 400 · 10 ³	> 400 · 10 ³	> 600 · 10 ³
Start-up delay	s	< 1	< 1	< 1
Dielectric strength between input/output	V AC	2500 (class II)	2500 (class II)	3000 (class II)
Dielectric strength between input/PE	V AC	—	—	—
Ambient temperature range****	°C	-20...+60	-20...+60	-20...+70
Protection category		IP 20	IP 20	IP 20

Approvals (according to type)



78.12....2400



• 24 V DC, 12 W output

78.12....1200



• 12 V DC, 12 W output

78.36



• 24 V DC, 36 W output

Replaceable fuse + spare



* (see diagrams P78)
 ** peak to peak, 100 Hz component, with 100 V AC input
 *** 88...100 V AC with output current limited to 80% I_N
 **** (see derating diagrams L78)

F

**60 W and 50 W High efficiency, low profile
Modular DC Power Supplies for electrical
cabinets**
Type 78.60

- Output 24 V DC, 60 W

Type 78.50

- Output 12 V DC, 50 W

- High efficiency (up to 91%)
- Low (< 0.4 W) stand-by power consumption
- Thermal protection: internal, with V_{out} shutdown - power OFF to reset
- Short circuit protection: Hiccup (auto-recovery) mode
- Input fuse: Easily replaceable plus spare
- Overvoltage protection: Varistor
- Flyback topology
- ZVS (Zero-voltage-switching), quasi-resonant mode switching
- Compliant with EN 60950-1 and EN 61204-3
- Parallel working for automatic redundancy - with OR diodes
- Dual Polarity and Series connection permissible
- Small dimensions: 70 mm (4-modules) wide, 61 mm deep
- 35 mm rail (EN 60715) mount

Screw terminal



For outline drawing see page 17

F
Output specification

Output current (-20...+40 °C, 230 V AC input)	A	2.8	4.6
Rated current I_N (50 °C, full input operating range)	A	2.5	4.2
Rated voltage	V	24	12
Rated power	W	60	50
Output power (-20...+40 °C, 230 V AC input)	W	68	55
Peak current capability for 3 ms*	A	10	12
Output voltage adjust	V	24...28	12...15
Voltage variation (from no-load to full-load)		< 1%	< 1%
Voltage ripple @ full load**	mV	< 200	< 200
Hold-up time @ full load: with 100 V AC input ms		> 20	> 30
with 260 V AC input ms		> 130	> 150

Input specification

Nominal voltage (U_N)	V AC (50/60 Hz)	110...240	110...240
	V DC (not polarized)	220	220
Operating range	V AC (50/60 Hz)	88...265	88...265
	V DC	140...370	140...370
Max power consumption (@ 100 V AC, 50 Hz)	VA	90	89
	W	67.5	58.3
Stand-by power consumption	W	< 0.4	< 0.4
Power factor		0.75	0.65
Max current consumption (@ 88 V AC)	A	0.9	0.85
Max. inrush current (peak @ 265 V) for 3 ms	A	30	30
Replaceable input fuse		1.6 A - T	1.6 A - T

Technical data

Efficiency (@ 230 V AC)	%	91	90
MTTF	h	> 500 · 10 ³	> 400 · 10 ³
Start-up delay	s	< 1	< 1
Dielectric strength between input/output	V AC	3000 (class II)	3000 (class II)
Dielectric strength between input/PE	V AC	1500 (class I)	1500 (class I)
Ambient temperature range***	°C	-20...+70	-20...+70
Protection category		IP 20	IP 20

Approvals (according to type)

CE EAC

78.60

- 24 V DC, 60 W output
- Output adjustable between 24-28 V
- ZVS technology

78.50

- 12 V DC, 50 W output
- Output adjustable between 12-15 V
- ZVS technology

Replaceable fuse + spare



* (see diagrams P78)

** peak to peak, 100 Hz component, with 100 V AC input

*** (see derating diagrams L78)

60 W and 50 W High efficiency, low profile Modular DC Power Supplies for electrical cabinets

Fold-Back overload characteristics for Battery charging applications and parallel working for increased load current

Type 78.61

- Output 24 V DC, 60 W

Type 78.51

- Output 12 V DC, 50 W

- High efficiency (up to 91%)
- Low (< 0.4 W) stand-by power consumption
- Thermal protection: internal, with V_{out} shutdown - power OFF to reset
- Short circuit protection: Hiccup (auto-recovery) mode
- Overload protection: Fold-back mode
- Input fuse: Easily replaceable plus spare
- Overvoltage protection: Varistor
- Flyback topology
- ZVS (Zero-voltage-switching), quasi-resonant mode switching
- Compliant with EN 60950-1 and EN 61204-3
- Parallel working for increased load current (with OR diodes)
- Dual Polarity and Series connection permissible
- Small dimensions: 70 mm (4-modules) wide, 60 mm deep
- 35 mm rail (EN 60715) mount

Screw terminal



For outline drawing see page 17

Output specification

Output current (-20...+40 °C, 230 V AC input)	A	2.6	4.6
Rated current I_N (50 °C, full input operating range)	A	2.5	4.2
Rated voltage	V	24	12
Rated power	W	60	50
Output power (-20...+40 °C, 230 V AC input)	W	68	55
Peak current capability for 3 ms*	A	8	12
Output voltage adjust	V	24...28	12...15
Voltage variation (from no-load to full-load)		< 1%	< 1%
Voltage ripple @ full load**	mV	< 200	< 200
Hold-up time @ full load:	with 100 V AC input ms	> 20	> 30
	with 260 V AC input ms	> 130	> 150

Input specification

Nominal voltage (U_N)	V AC (50/60 Hz)	110...240	110...240
	V DC (not polarized)	220	220
Operating range	V AC (50/60 Hz)	88...265	88...265
	V DC	140...370	140...370
Max power consumption (@ 100 V AC, 50 Hz)	VA	90	89
	W	67.5	58.3
Stand-by power consumption	W	< 0.4	< 0.4
Power factor		0.75	0.65
Max current consumption (@ 88 V AC)	A	0.9	0.85
Max. inrush current (peak @ 265 V) for 3 ms	A	30	30
Replaceable input fuse		1.6 A - T	1.6 A - T

Technical data

Efficiency (@ 230 V AC)	%	91	90
MTTF	h	> 500 · 10 ³	> 400 · 10 ³
Start-up delay	s	< 1	< 1
Dielectric strength between input/output	V AC	3000 (class II)	3000 (class II)
Dielectric strength between input/PE	V AC	1500 (class I)	1500 (class I)
Ambient temperature range***	°C	-20...+70	-20...+70
Protection category		IP 20	IP 20

Approvals (according to type)



- 24 V DC, 60 W output
- Output adjustable between 24-28 V
- ZVS technology
- Suitable for battery charging



- 12 V DC, 50 W output
- Output adjustable between 12-15 V
- ZVS technology
- Suitable for battery charging

Replaceable fuse + spare



* (see diagrams P78)

** peak to peak, 100 Hz component, with 100 V AC input

*** (see derating diagrams L78)

suitable for battery charging (see details page 11)

**Industrial Switch Mode DC Power Supplies:
120 W and 130 W**
**Fold-Back overload characteristics for Battery
charging applications and parallel working
for increased load current**
Type 78.1C

- Output 24 V DC, 120 W

Type 78.1D

- Output 24 V DC, 130 W
- Double stage active Power Factor Correction
- High efficiency (up to 90%)
- Low stand-by power consumption
- Forward topology
- Thermal protection: internal with pre-alert alarm via LED and auxiliary contact, and with V_{out} safety shutdown - power OFF to reset
- Overload indication: Pre-alert alarm via LED and auxiliary contact indication
- Boost current: Without time limit, with LED and auxiliary contact indication
- Overload protection: Fold-back mode
- Short circuit protection: Hiccup (auto-recovery) mode
- Input fuse: Easily replaceable plus spare
- Overvoltage protection: Varistor
- Compliant with EN 60950-1 and 61204-3
- Parallel working for increased load current (with OR diodes)
- Dual Polarity and Series connection permissible
- 35 mm rail (EN 60715) mount

78.1C

- 24 V DC, 120 W output
- Output adjustable between 24-28 V

78.1D

- 24 V DC, 130 W output
- Output adjustable between 24-28 V
- Double stage with active PFC (Power Factor Correction)

 Replaceable fuse
+ spare

 Thermal protection
with LED indication

 Auxiliary contact
signalling

* (see diagrams P78)

** peak to peak, 100 Hz component, with 110 V AC input

*** (see derating diagrams L78)

 suitable for battery charging (see details page 11)

F

For outline drawing see page 17

Output specification

Output current (-20...+40 °C, 230 V AC input)	A	5.4	5.4
Rated current I_N (50 °C, full input operating range)	A	5	5.4
Rated voltage	V	24	24
Rated power	W	120	130
Output power (-20...+40 °C, 230 V AC input)	W	130	130
Peak current capability for 5 ms*	A	15	10
Output voltage adjust	V DC	24...28	24...28
Voltage variation (from no-load to full-load)		< 1%	< 1%
Voltage ripple @ full load**	mV	< 100	< 100
Hold-up time @ full load: with 110 V AC input ms		> 10	> 20
with 260 V AC input ms		> 80	> 20

Input specification

Nominal voltage (U_N)	V AC (50/60 Hz)	120...240	110...240
	V DC	220	110...240
Operating range	V AC (50/60 Hz)	110...265	88...265
	V DC	155...275 (polarized)	95...275 (non-polarized)
Drop out DC Voltage	V	140 (with $I_{output} = 2.5$ A)	80
Max power consumption (@ minimum V AC operating range)	VA	195 (@ 60 Hz)	145 (@ 50 Hz)
	W	137 (@ 60 Hz)	145 (@ 50 Hz)
Stand-by power consumption	W	< 2.1	< 3.3
Power factor		0.7	0.998
Max current consumption	A	1.7 (@ 110 V AC)	1.6 (@ 88 V AC)
Max. inrush current (peak @ 265 V) for 3 ms	A	10	12
Replaceable input fuse		2.5 A - T	2.5 A - T

Technical data

Efficiency (@ 230 V AC)	%	90	89
MTTF	h	> 500 · 10 ³	> 400 · 10 ³
Start-up delay	s	< 1	< 1
Dielectric strength between input/output	V AC	2500 (class II)	2500 (class II)
Dielectric strength between input/PE	V AC	1500 (class I)	1500 (class I)
Ambient temperature range***	°C	-20...+70	-20...+70
Protection category		IP 20	IP 20

Approvals (according to type)

Industrial Switch Mode DC Power Supply: 240 W

Overload characteristics support parallel working for increased load current

Type 78.2E

- Output 24 V DC, 240 W
- Double stage active Power Factor Correction
- High efficiency (up to 93%)
- Low stand-by power consumption
- Forward topology
- Thermal protection: internal with pre-alert alarm via LED and auxiliary contact, and with V_{out} safety shutdown - power OFF to reset
- Overload indication: Pre-alert alarm via LED and auxiliary contact indication
- Boost current: Without time limit, with LED and auxiliary contact indication
- Overload up to 20 A
- Short circuit protection: Hiccup (auto-recovery) mode
- Input fuse: Easily replaceable plus spare
- Overvoltage protection: Varistor
- Compliant with EN 60950-1 and 61204-3
- Parallel working for increased load current (with OR diodes)
- Dual Polarity and Series connection permissible
- 35 mm rail (EN 60715) mount

Screw terminal



For outline drawing see page 18

Output specification

Output current (-20...+40 °C, 230 V AC input)	A	10.8
Rated current I _N (50 °C, full input operating range)	A	10
Rated voltage	V	24
Rated power	W	240
Output power (-20...+40 °C, 230 V AC input)	W	250
Peak current capability for 5 ms*	A	25
Output voltage adjust	V DC	24...28
Voltage variation (from no-load to full-load)		< 1%
Voltage ripple @ full load**	mV	< 100
Hold-up time @ full load: with 110 V AC input	ms	> 20
with 260 V AC input	ms	> 20

Input specification

Nominal voltage (U _N)	V AC (50/60 Hz)	110...240
	V DC	110...240
Operating range	V AC (50/60 Hz)	88...265
	V DC	90...275 (non-polarised)
Drop out DC Voltage	V	80
Max power consumption (@ minimum V AC operating range)	VA	275 (@ 50 Hz)
	W	274 (@ 50 Hz)
Stand-by power consumption (@ 88 V)	W	≤ 2.8
Power factor		0.995
Max current consumption	A	3.0 (@ 88 V AC)
Max. inrush current (peak @ 265 V) for 3 ms	A	12
Replaceable input fuse		3.15 A - T

Technical data

Efficiency (@ 230 V AC)	%	93
MTTF	h	> 400 · 10 ³
Start-up delay	s	< 1
Dielectric strength between input/output	V AC	2500 (class II)
Dielectric strength between input/PE	V AC	1500 (class I)
Ambient temperature range***	°C	-20...+70
Protection category		IP 20

Approvals (according to type)

NEW 78.2E



- 24 V DC, 240 W output
- Output adjustable between 24-28 V
- Double stage with active PFC (Power Factor Correction)

Replaceable fuse + spare



Thermal protection with LED indication



Auxiliary contact signalling



* (see diagrams P78)

** peak to peak, 100 Hz component, with 110 V AC input

*** (see derating diagrams L78)

Ordering information

Example: 78 series switch mode power supply, 36 W - 24 V DC output, supply voltage 110...240 V AC, replaceable fuse.

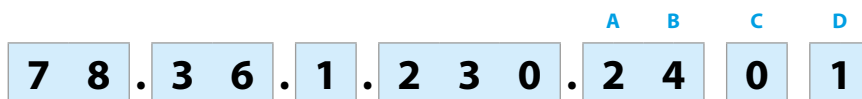

Series

Power

12 = 12 W output
36 = 36 W output
50/51 = 50 W output
60/61 = 60 W output
1C = 120 W output
1D = 130 W output
2E = 240 W output

Voltage conversion

1 = AC input, DC output

Input voltage

230 = 110...240 V AC

D:

0 = Standard
1 = Replaceable fuse
3 = Replaceable fuse +
output voltage regulator
4 = Fuse + regulator + positive
logic contact
5 = Fuse + regulator +
pre-alarm contact

C:

0 = Standard
1 = Double stage, with PFC
(Power Factor Correction)

AB:

12 = 12 V output
24 = 24 V output

Codes

78.12.1.230.1200
78.12.1.230.2400
78.36.1.230.2401
78.50.1.230.1203
78.51.1.230.1203
78.60.1.230.2403
78.61.1.230.2403
78.1C.1.230.2404
78.1C.1.230.2405
78.1D.1.230.2414
78.1D.1.230.2415
78.2E.1.230.2414
78.2E.1.230.2415

Technical data

EMC specifications (according to EN 61204-3)		Reference standard	78.12, 78.36	78.60, 78.50	78.61, 78.51	78.1C, 78.1D	78.2E
Electrostatic discharge	contact discharge	EN 61000-4-2	4 kV	4 kV	4 kV	4 kV	4 kV
	air discharge	EN 61000-4-2	8 kV	8 kV	8 kV	8 kV	8 kV
Radiated electromagnetic field	80...1000 MHz	EN 61000-4-3	6 V/m	10 V/m	10 V/m	10 V/m	10 V/m
	1...2.8 GHz	EN 61000-4-3	3 V/m	3 V/m	3 V/m	3 V/m	10 V/m
Fast transients (burst 5/50 ns, 5 and 100 kHz)	on supply terminals	EN 61000-4-4	2 kV	3 kV	3 kV	3 kV	3 kV
Voltage pulses on supply terminals (surge 1.2/50 µs)	common mode	EN 61000-4-5	2 kV	2 kV	2 kV	3 kV	2.5 kV
	differential mode	EN 61000-4-5	2 kV (78.12), 4 kV* (78.36)	4 kV*	4 kV*	4 kV**	4 kV**
Radio-frequency common mode voltage (0.15...230 MHz)	on supply terminals	EN 61000-4-6	6 V	10 V	10 V	10 V	10 V
Short interruptions		EN 61000-4-11	5 cycles	6 cycles	6 cycles	6 cycles	5 cycles
Radio-frequency conducted emissions	0.15...30 MHz	EN 55022	class B	class A	class B	class B	class B
Radiated emissions	30...1000 MHz	EN 55022	class B	class A	class B	class A	class A
Terminals			Max			Max...Min	
Wire size (Solid cable, stranded cable)	mm ²		1 x 4 / 2 x 2.5			1 x 4...1 x 0.5	
	AWG		1 x 12 / 2 x 14			1 x 12...1 x 20	
 Screw torque	Nm		0.8			0.5	
Wire strip length	mm		9			9	
Other data							
Power lost to the environment with rated output current	W		2 (78.12), 5 (78.36, 78.50/51), 5.4 (78.60/61)				
	W		12 (78.1C), 13.2 (78.1D), 16.8 (78.2E)				

* input fuse may blow for surges higher than 1.5 kV

** input fuse may blow for surges higher than 2 kV

Output specification

L78-1 Output current v ambient temperature (78.12)

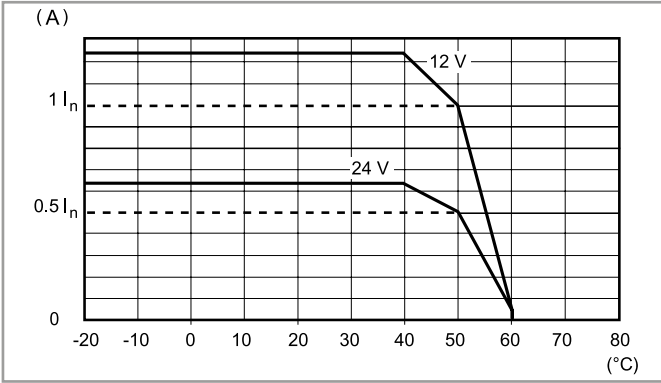

P78-1 Output peak current v time (78.12)

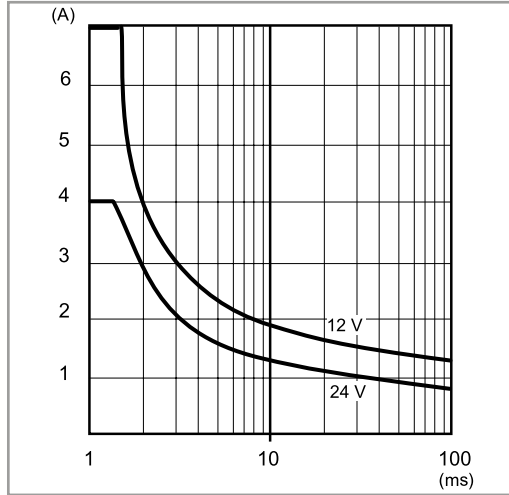

L78-2 Output current v ambient temperature (78.36)

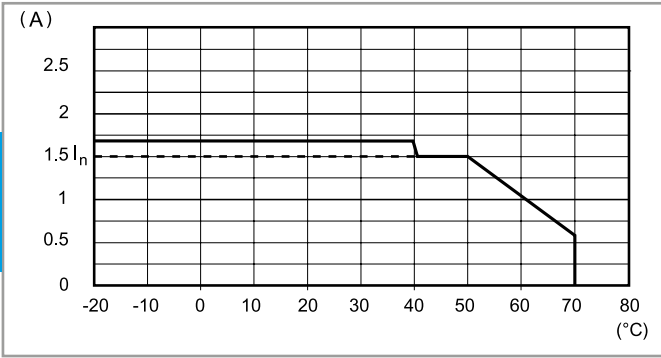

P78-2 Output peak current v time (78.36)

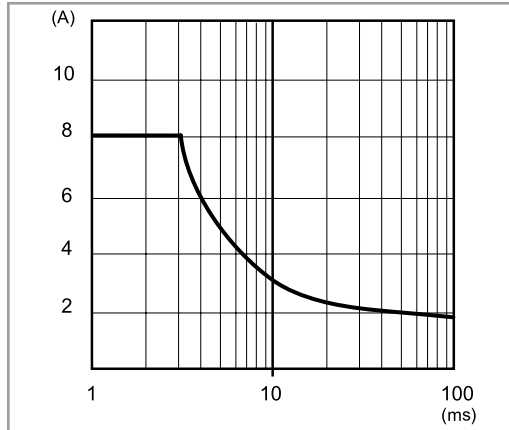

L78-3 Output current v ambient temperature (78.60)

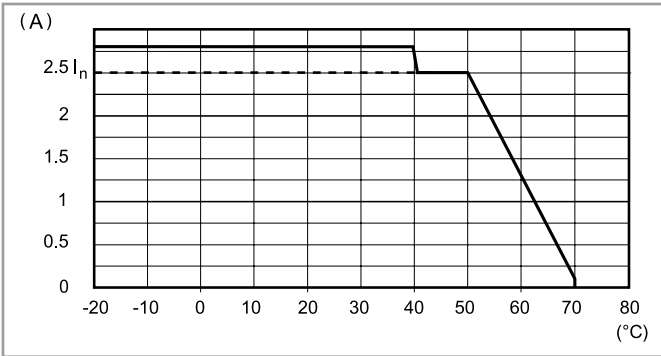

P78-3 Output peak current v time (78.60)

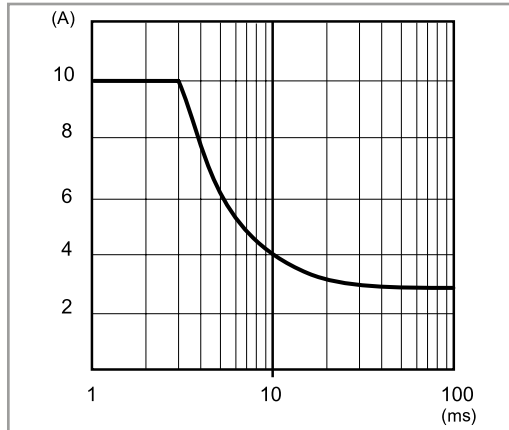

L78-4 Output current v ambient temperature (78.50/51)

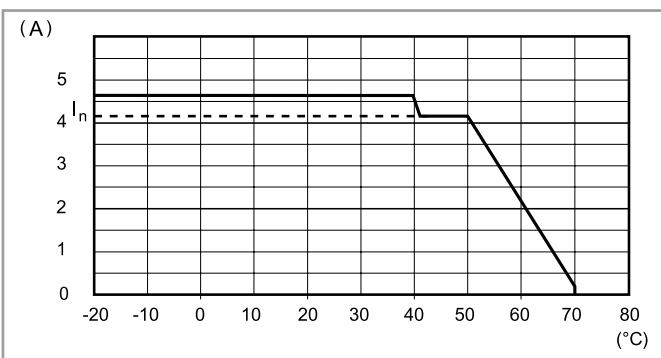

P78-4 Output peak current v time (78.50/51)

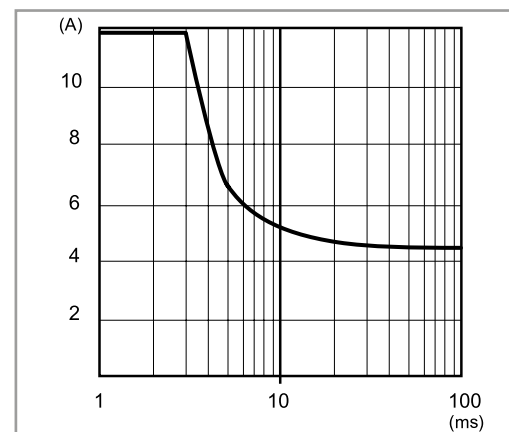

F

Output specification

L78-5 Output current v ambient temperature (78.61)

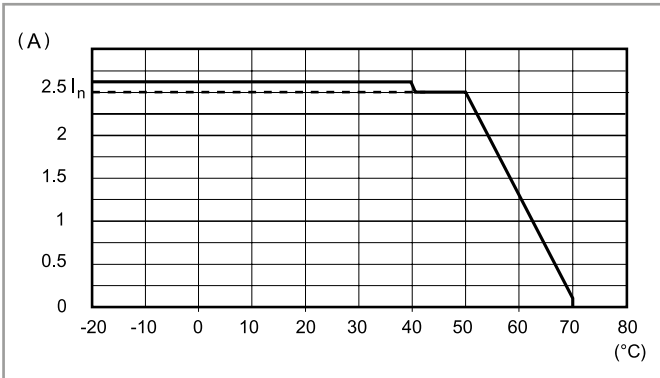

P78-5 Output peak current v time (78.61)

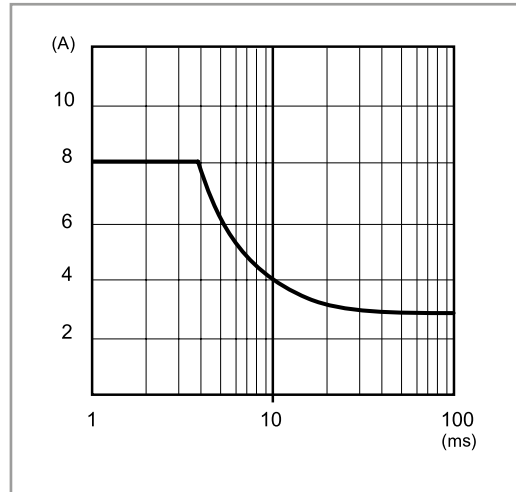

L78-5 Output current v ambient temperature (78.1C)

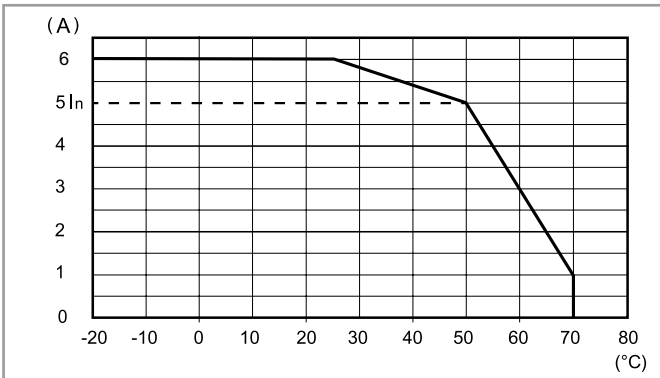

P78-5 Output peak current v time (78.1C)

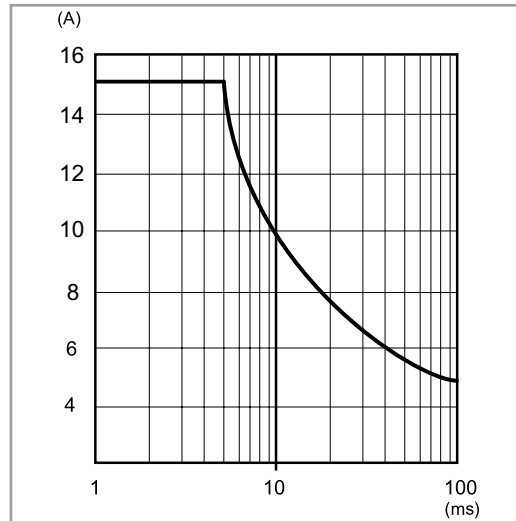

L78-6 Output current v ambient temperature (78.1D)

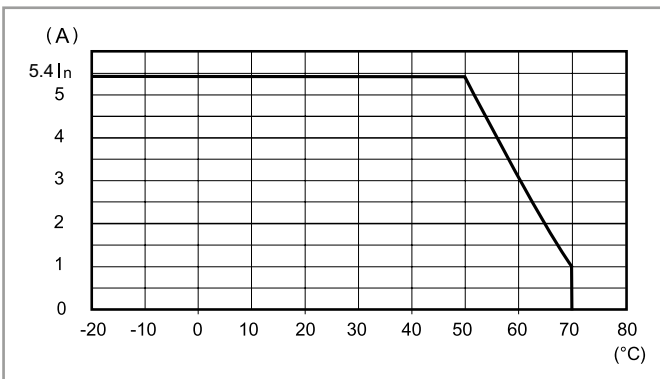

P78-6 Output peak current v time (78.1D)

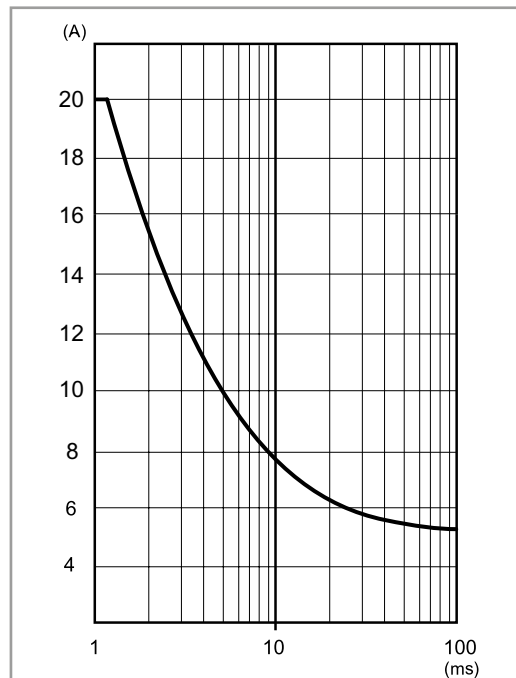

F

Output specification

L782E-1 Output current v ambient temperature (78.2E)

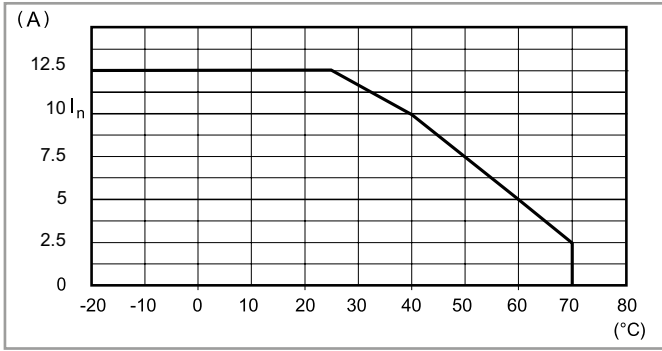

P782E-1 Output peak current v time (78.2E)

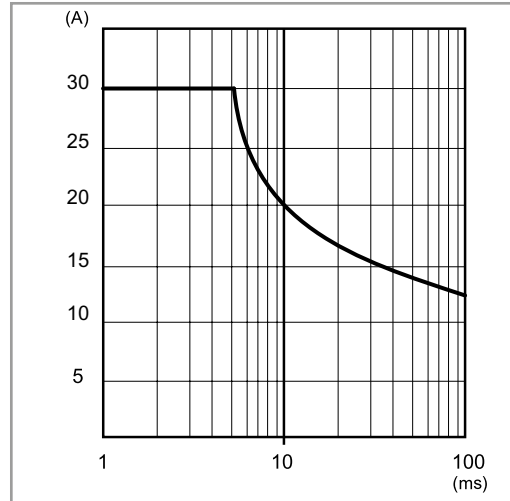

Hiccup mode

F

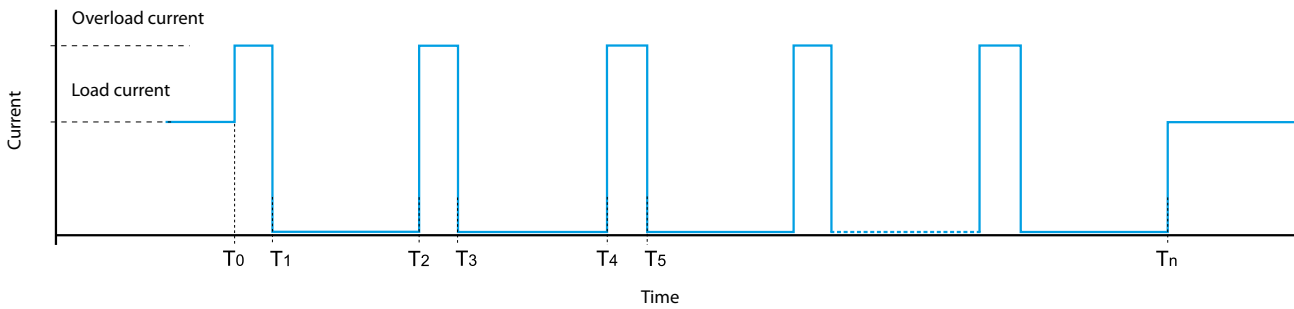

Under normal conditions, the 78 Series Power Supply supplies the current required by the load. However, under abnormal conditions such as a short circuit or heavy overload (T_0) the output voltage will be rapidly reduced to zero - followed by the current (T_1). After approximately 2 seconds (T_1 to T_2), the power supply checks for the persistence of the anomaly over the time period T_2 to T_3 (30 to 100ms - dependent on the type of anomaly). If the anomaly persists, as shown above, the current is again reset to 0 A for a further 2 s (T_3 to T_4). This "hiccup" process is repeated until the anomaly is removed (T_n), whereon the power supply then returns to normal working.

Output specification

FB78-1 Output voltage vs output current (78.51)

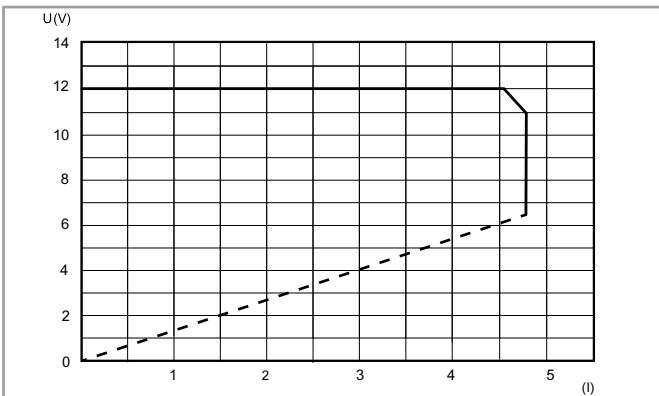

FB78-2 Output voltage vs output current (78.61)

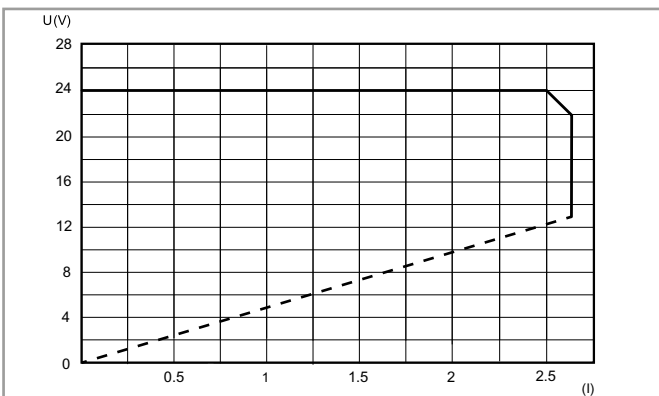

FB78-3 Output voltage vs output current (78.1C)

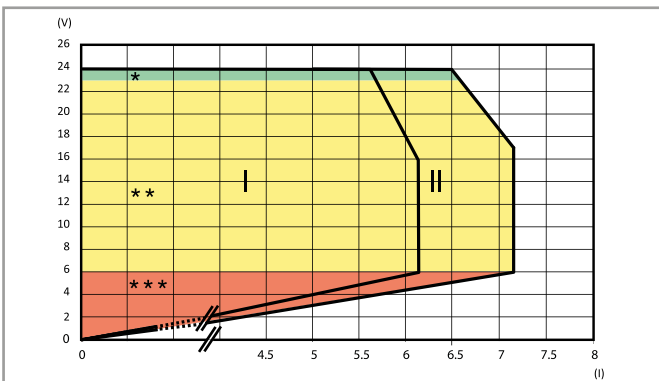

I: Fold-back characteristic for temperature up to 50 °C
II: Fold-back characteristic for temperature up to 25 °C
* / ** / ***: See LED table below

Fold-back technology allows load current to be maintained under conditions of heavy overload. In case of heavy overload, the fold-back circuit will provide the output current and the output voltage, in accordance with the relevant "FB" diagram. In practice, when overcurrent is drawn by the load, the fold-back circuit reduces the output voltage supplying the current up to the maximal value, then it starts to work in hiccup mode. Also in case of short circuit, the power supply will work in hiccup mode. Both these conditions end when the anomaly is removed, and the power supply returns to normal working.

The fold-back mode allows the use of the power supply as a battery charger, in particular 78.51/61 for charging lead batteries rated 7...24 Ah and 78.1C/1D for charging lead batteries rated 17...38 Ah. It is suggested to insert a diode in series between the + output and the + input of the battery (if not already installed in the battery unit).

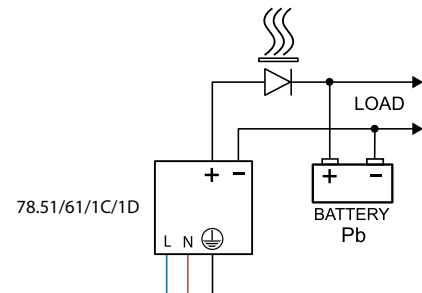

FB78-4 Output voltage vs output current (78.1D)

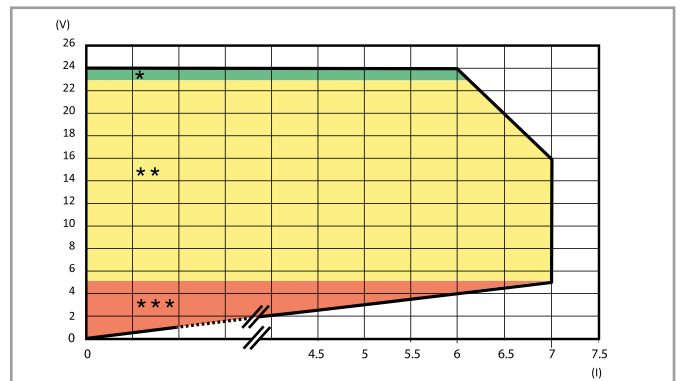

Fold-back characteristic for ambient temperature up to 50 °C
* / ** / ***: See LED table below

FB78-5 Output voltage vs output current (78.2E)

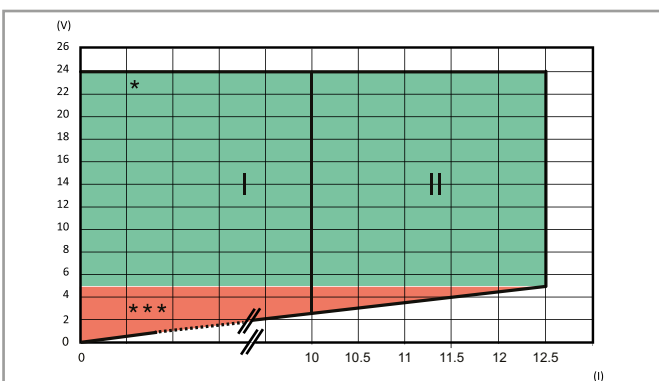























I: Output characteristic for temperature up to 50 °C
II: Output characteristic for temperature up to 25 °C
* / ***: See LED table below

78.1C, 78.1D, 78.2E LED table

Feedback contact switching mode: Type 78.xx.x.xxx.24x4 ("positive logic")

The NO contact closes when power is applied to the unit and remains closed unless there is a serious fault preventing the power supply unit from delivering output current. (Such as a broken fuse, power supply failure, short-circuit or thermal protection.)

This version is suitable, for example, for signalling to a remote PLC all those alarms representing a service interruption of the power supply output.

Type	Area	State	LED	Contact 13-14
78.1C.1.230.2404 78.1D.1.230.2414 78.2E.1.230.2414	*	OK	DC OK  ALARM   OFF	
	**	Overload (78.1C/1D only)	DC OK  ALARM   OFF	
	***	Short circuit	DC OK  ALARM   OFF	
		Thermal limit	DC OK  ALARM   OFF	
		Thermal protection [#]	DC OK  ALARM   OFF	

[#]Remove the supply voltage, following the intervention of the thermal protection, in order to reset the power supply.























78.1C, 78.1D, 78.2E LED table

F

Feedback contact switching mode: Type 78.xx.x.xxx.24x5 ("pre-alarm")



The NO contact closes when an anomaly happens (Overload, short circuit, thermal limit, thermal protection).

This version is suitable, for example, for activating visual or audible alarms, or to activate a cooling fan.

Type	Area	State	LED	Contact 13-14
78.1C.1.230.2405 78.1D.1.230.2415 78.2E.1.230.2415	*	OK	DC OK  ALARM   OFF	
	**	Overload (78.1C/1D only)	DC OK  ALARM   OFF	
	***	Short circuit	DC OK  ALARM   OFF	
		Thermal limit	DC OK  ALARM   OFF	
		Thermal protection [#]	DC OK  ALARM   OFF	

[#]Remove the supply voltage, following the intervention of the thermal protection, in order to reset the power supply.

78.12, 78.36, 78.50, 78.60, 78.51, 78.61 LED table

Type	State	LED
78.12.1.230.xx00 78.36.1.230.2401 78.50.1.230.1203 78.60.1.230.2403 78.51.1.230.1203 78.61.1.230.2403	OK	
	Short circuit	
	Thermal limit	OFF

Wiring diagrams for 78.12, 78.36, 78.50, 78.51, 78.60 & 78.61

Basic connections

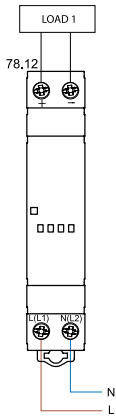

Basic connections

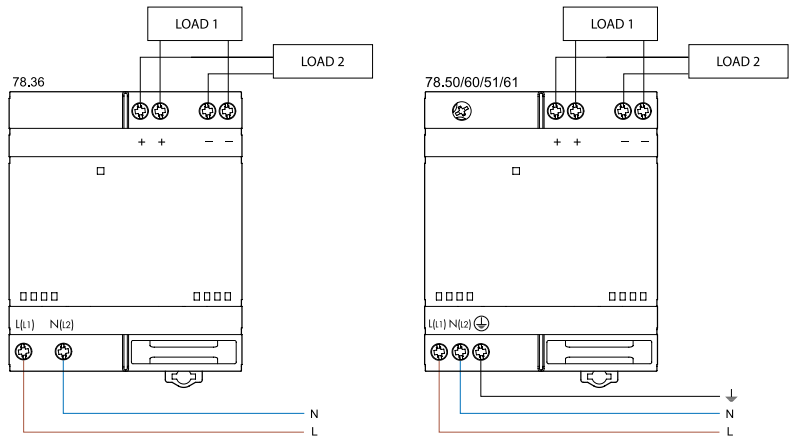

Dual polarity connection

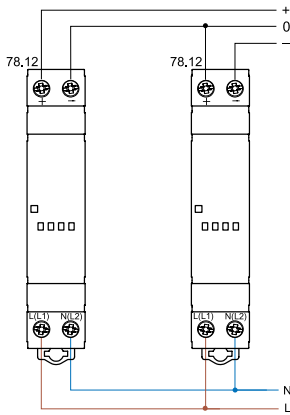

Dual polarity connection

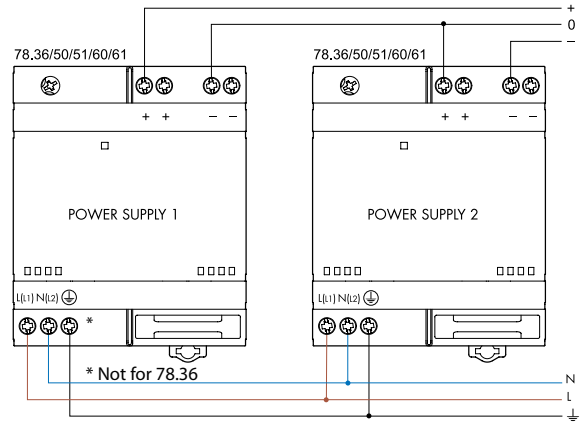

Series connection

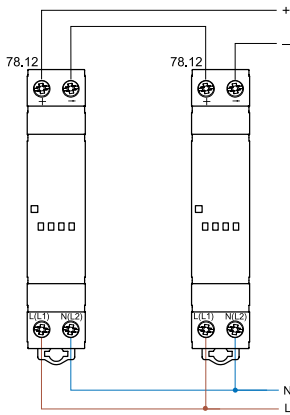

Series connection

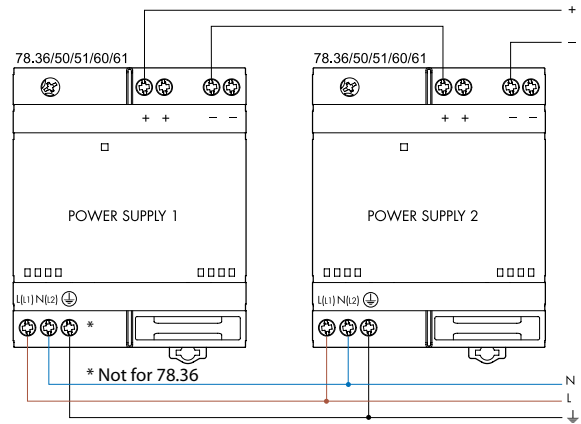

Parallel connection (78.51/61 only)

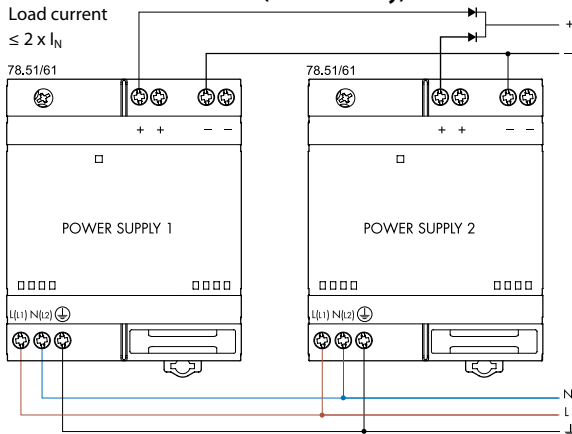

Manual redundancy

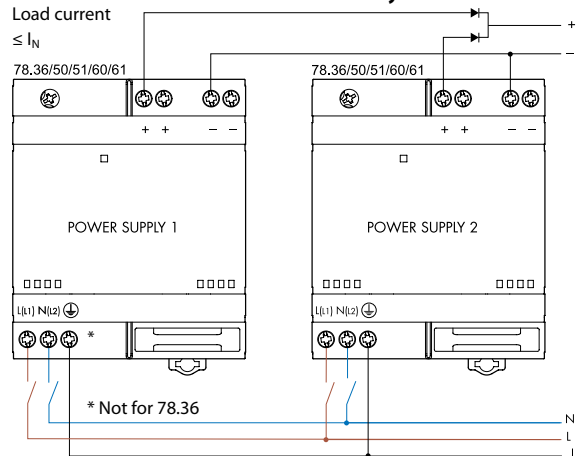

Wiring diagrams for 78.1C & 78.1D

Basic connections

78.1C - Power supply connection

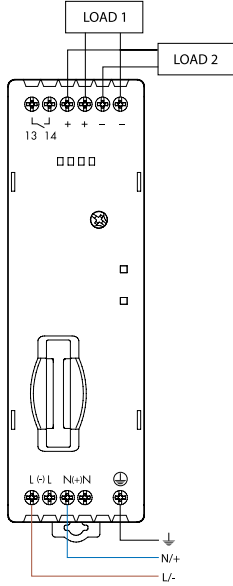

78.1D - Power supply connection

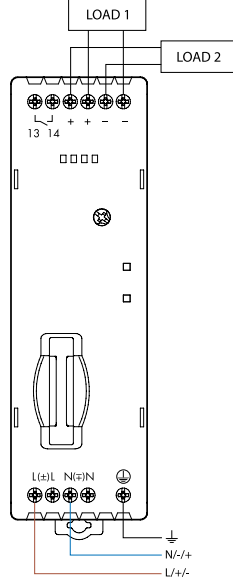

Dual polarity connection

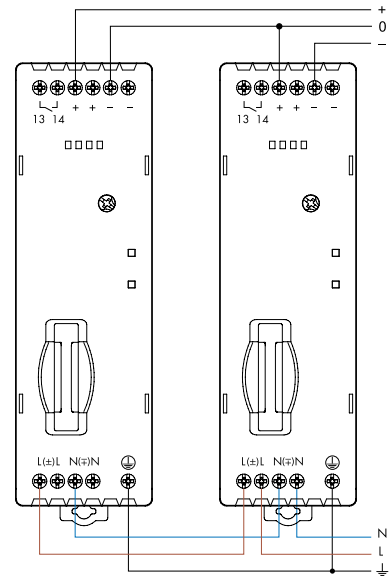

Parallel connection

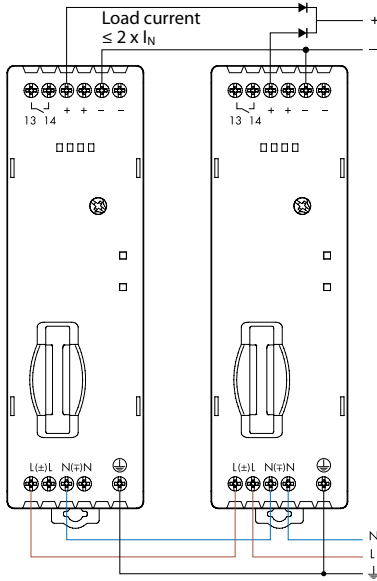

Series connection

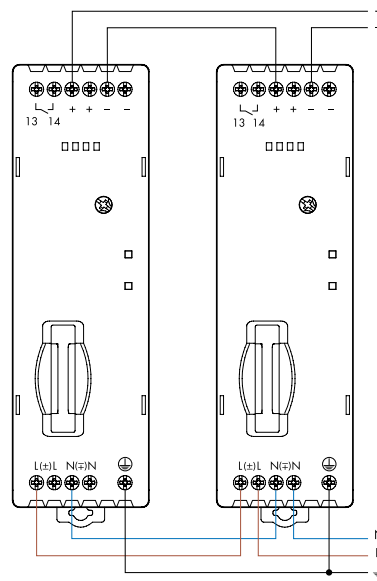

F

Wiring diagrams for 78.2E

Basic connections

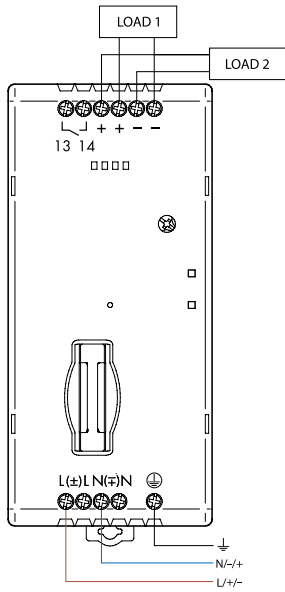

Dual polarity connection

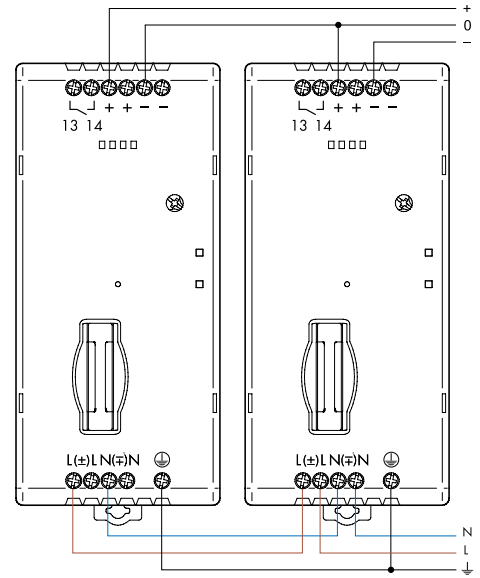

Parallel connection

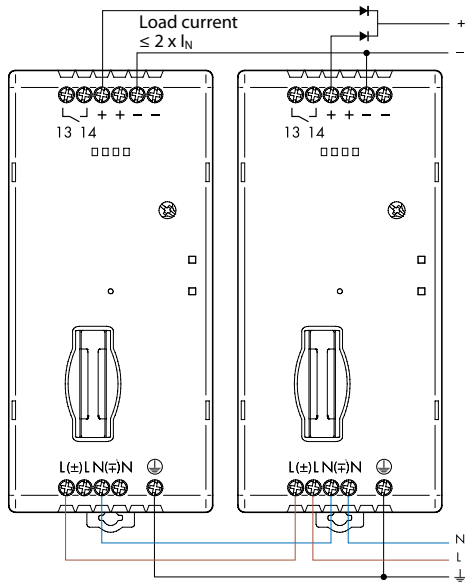

Series connection

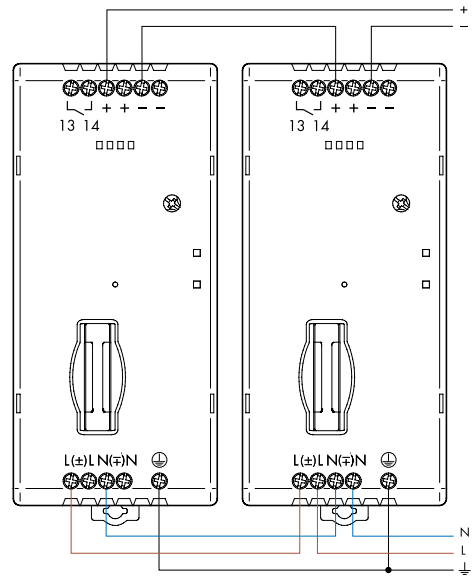

F

Diode(s)

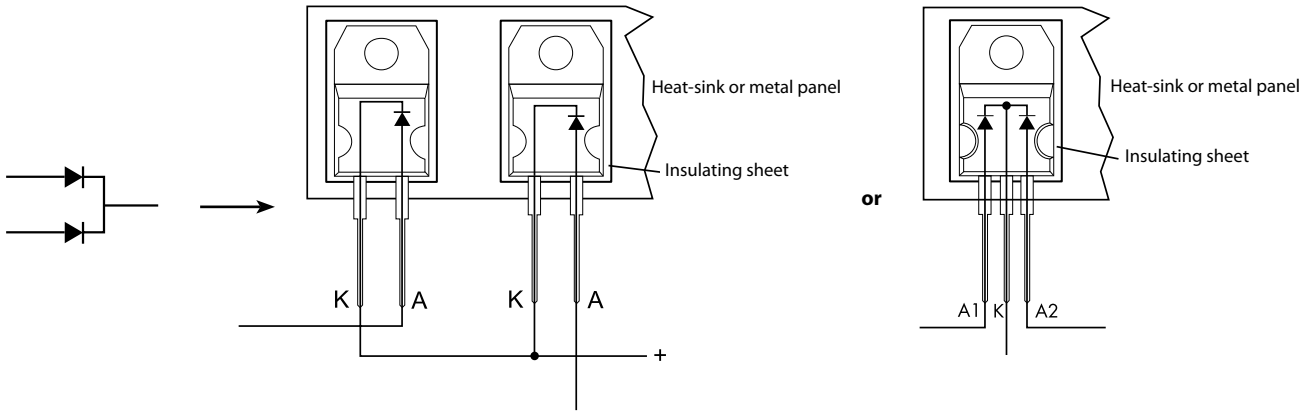

Diode for type 78.12, 78.36, 78.50, 78.60

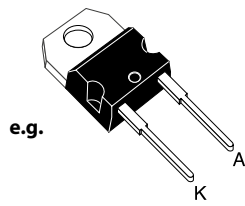

TO-220AC
STPS1545D

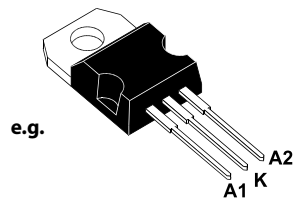

TO-220AB
STPS30L40CT

Diode for type 78.1C, 78.1D, 78.2E

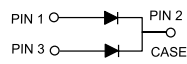
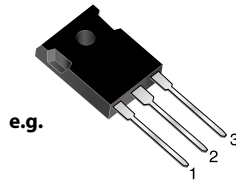

TO-247AD
MBR 4060PT

Outline drawings

78.12
Screw terminal

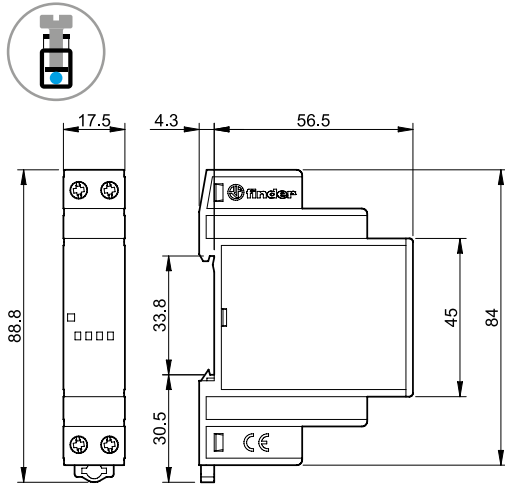

78.36
Screw terminal

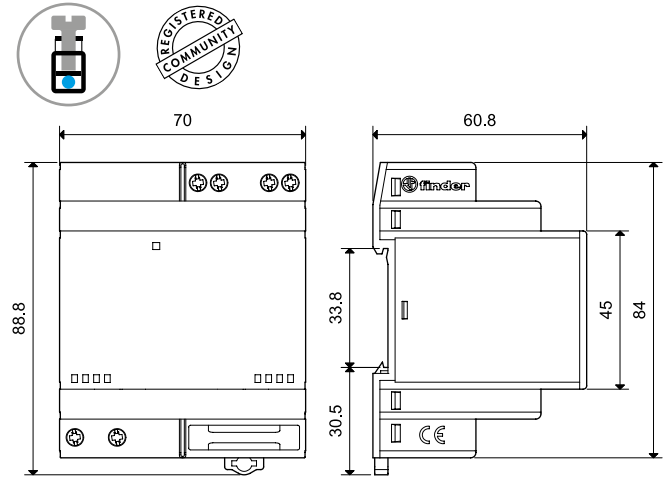

78.50 / 78.60
Screw terminal

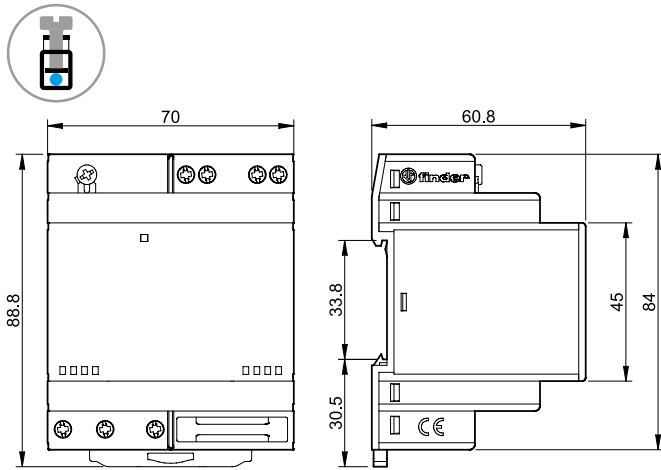

78.51 / 78.61
Screw terminal

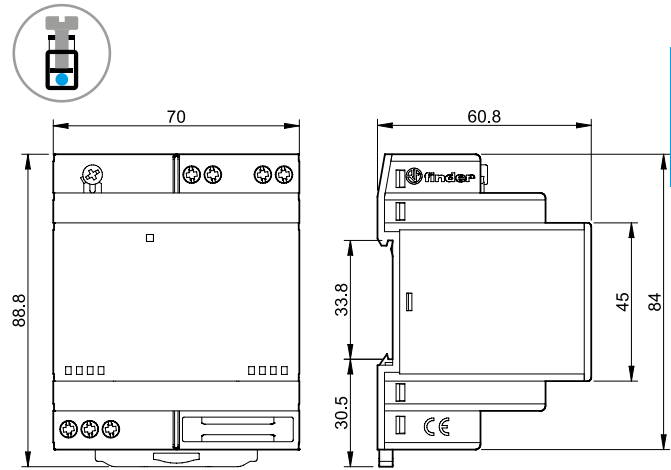

78.1C / 78.1D
Screw terminal

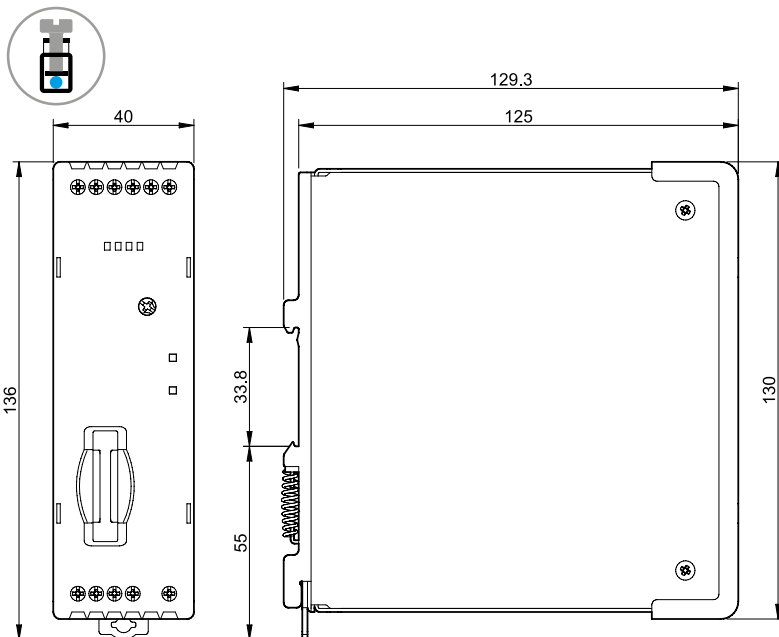

Outline drawings

78.2E

Screw terminal

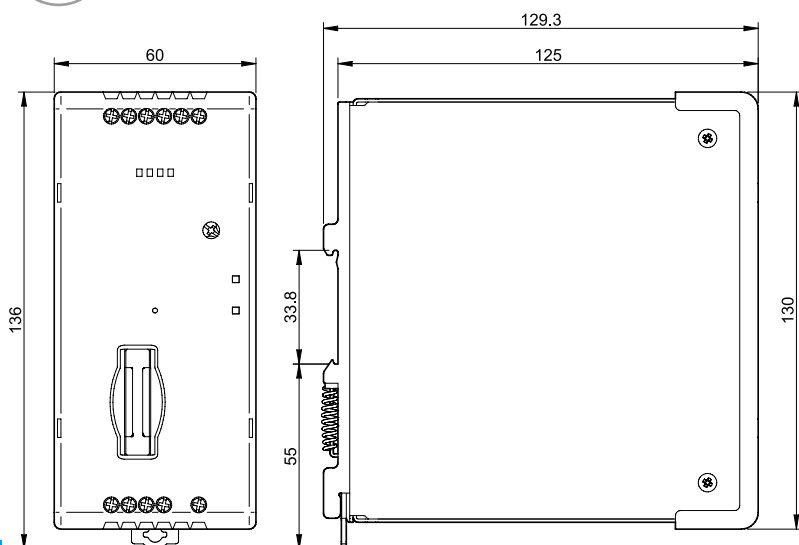

F

Accessories

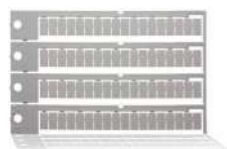

060.72

Sheet of marker tags, plastic, 72 tags, 6 x 12 mm

060.72

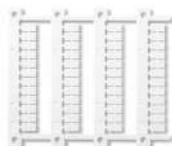

060.48

Sheet of marker tags (CEMBRE'S Thermal transfer printers), (48 tags), 6 x 12 mm

060.48



019.01

Identification tag, plastic, 1 tag, 17 x 25.5 mm (for 78.12/36/50/60/51/61)

019.01